



# **FLEXTECH STUDY**

**For**

**City of Beacon - LED Street Lighting  
One Municipal Plaza, Suite One  
Beacon, NY 12508**

**New York State Energy Research and  
Development Authority  
17 Columbia Circle  
Albany, New York 12203-6399**

**Date: 6/15/16**

For questions regarding this report, please contact [FlexTech@nyserda.ny.gov](mailto:FlexTech@nyserda.ny.gov).

We hope the findings of this report will assist you in making decisions about energy efficiency improvements in your facility. Thank you for your participation in this program.

### **NOTICE**

This report was prepared pursuant to the Flexible Technical Assistance Program (Hereinafter "FlexTech") administered by the New York State Energy Research and Development Authority (hereinafter "NYSERDA"). The opinions expressed in this report do not necessarily reflect those of NYSERDA or the State of New York, and reference to any specific product, service, process, or method does not constitute an implied or expressed recommendation or endorsement of it by NYSERDA or the State of New York. Further, NYSERDA and the State of New York make no warranties or representations, expressed or implied, as to the fitness for a particular purpose or merchantability of any product, apparatus, or service, or the usefulness, completeness, or accuracy of any processes, methods, energy savings, or other information contained, described, disclosed, or referred to in this report. NYSERDA and the State of New York make no representation that the use of any product, apparatus, process, method, or other information will not infringe privately-owned rights and will assume no responsibility for any loss, injury, or damage resulting from, or occurring in connection with, the use of information contained, described, disclosed, or referred to in this report.

State of New York  
Andrew Cuomo, Governor

New York State Energy Research and Development Authority

## TABLE OF CONTENTS

---

TITLE	SECTION
EXECUTIVE SUMMARY .....	1
UTILITY DESCRIPTION .....	2
ECM 1 – STREET LIGHTING LED RETROFIT .....	3
ECM 2 – TRAFFIC SIGNAL LED RETROFIT .....	4
APPENDIX A – UTILITY INFORMATION.....	A
<ul style="list-style-type: none"><li>• Central Hudson Electric Utility Summaries</li><li>• Central Hudson Service Classification 8</li><li>• Central Hudson LED Fixture Delivery Rate Statement</li><li>• Central Hudson Service Classification 9</li><li>• Central Hudson Service Classification 2</li></ul>	
APPENDIX B – STREET LIGHTING DATA .....	B
<ul style="list-style-type: none"><li>• Central Hudson Attachment Agreement</li><li>• Central Hudson Street Lighting Database</li><li>• Surveyed Street Lighting Field Record Construction Report</li></ul>	
APPENDIX C – TRAFFIC SIGNAL DATA .....	C
<ul style="list-style-type: none"><li>• Central Hudson Traffic Signal Database</li><li>• Surveyed Traffic Signal Field Record Construction Report</li></ul>	
APPENDIX D – LED LIGHTING CUT SHEETS .....	D



## EXECUTIVE SUMMARY

The City of Beacon is interested in improving the City's street lighting and traffic signal fleet. The objectives of this project include reducing the City's energy consumption and operating expenses and making a positive impact on the environment by reducing their carbon footprint. A study of potential improvements to the street lighting and traffic signals was performed to allow City officials to make informed implementation decisions based energy, operational and maintenance savings. This study was conducted to identify the improvements that the City could implement to reduce annual energy and operational costs while maintaining current lighting outputs.



Based on the analysis included in this study it is recommended for the City to implement the retrofit of Street Lights and Traffic Signals. Below is a bulleted list of the recommended measures.

- ECM 1 – Street Lighting LED Retrofit
- ECM 2 – Traffic Signal LED Retrofit

The following “Total Project Summary” (Table 1-1) summarizes the selected project economics and results of the study. The details in the table demonstrate the estimated savings, implementation costs, carbon reductions and simple payback periods for each of the selected measures. This comprehensive project is aimed toward improving the total functionality of the city's street lighting fleet in regards to efficiency, operation and maintenance.

**City of Beacon Street Lighting  
TOTAL PROJECT SUMMARY -DRAFT  
2/3/2016**

(Yes (N)o (O)ption	ECM No.	Energy Conservation Measure	Total Measure Cost <sup>1</sup> (\$)	Annual Demand Savings (kW)	Annual Electric Savings (kWh)	Annual Utility Charge Savings (\$)	Average Annual Maintenance Costs (\$)	Annual O&M Savings <sup>4</sup> (\$)	Annual Electric Savings (\$)	Total Annual Savings (\$)	Simple Payback Period <sup>2</sup>
Y	1	Street Lighting with 3% Extra Stock <sup>3</sup>	\$1,557,673	\$218.52	819,914	\$ 178,510	\$ 32,679	\$145,831	\$63,962	\$209,793	7.4
Y	2	Traffic Signals	\$93,095	\$0	61,015	\$ (1,598)	\$ (253)	-\$1,345	\$5,602	\$4,256	21.9
<b>PROGRAM TOTALS - Recommended Measures</b>			<b>\$1,650,768</b>	<b>\$219</b>	<b>880,928</b>	<b>\$176,912</b>	<b>\$32,426</b>	<b>\$144,486</b>	<b>\$69,564</b>	<b>\$214,050</b>	<b>7.7</b>

**NOTES:**

- TOTAL MEASURE COST includes direct construction costs (subcontractor material and labor) and DOES include fees for the following services: Energy, Electrical and Mechanical engineering, Construction documents, Financing assistance services, Subcontractor coordination and administration
- SIMPLE PAYBACK periods DO NOT include incentives. Payback is given by the total measure cost divided by total annual savings.
- Street Lighting cost are based on moderately priced fixtures. Fixture style and manufacturer will be finalized with the city's input and may increase or decrease the project cost.
- ANNUAL O&M SAVINGS are a summation of the Annual Utility Charge Savings and the Average Annual Maintenance Costs





## UTILITY DESCRIPTION

The City of Beacon traffic signals and street lighting currently are provided by unmetered power from Central Hudson Gas and Electric (CHGE). Delivery of electrical service is charged by a flat fee based on the equipment and what is specified in the tariff. Supply of energy is provided by CHGE at market prices as current tariffs do not allow for the purchase of deregulated power. The electrical consumption rate that was calculated by using a 12 month average from May 2013 to April 2014 and is detailed in Appendix A of this report.

Service	Rate	Unit
Street Lighting	\$0.08776	kWh
Traffic Signals	\$0.09359	kWh

The City of Beacon has one thousand four hundred and fifty-two (1,452) streetlights under Central Hudson Service Classification (SC) 8. Of these lights, thirty-six (36) are owned and maintained by the City (Rate C), four hundred and two (402) are owned by the city but maintained by CHGE (Rate B) and the remaining one thousand fourteen (1,014) are owned and maintained by CHGE (Rate A).

Under SC-8, the City pays for maintenance for the streetlights under Rate A and B. This payment is an annual payment that is split up over twelve (12) months of billing. The energy is charged based on the wattage that the fixtures are listed at multiplied by a set amount of hours that the light is assumed on during the night. The hours total four thousand two and a half (4,002.5) a year (this accounts for the added time in the leap year). For the streetlights under Rate C, City owned and maintained, a set fee for the fixture is charged. The fees for Rate C are based on the type and wattage of the fixture. Energy usage is calculated the same way as in Rate A and B.

The City's traffic signals are billed under Central Hudson Service Classification (SC) 9. The monthly billing is primarily comprised of two components: (1) a usage rate that applies to energy ratings (49 kWh per face per month) and (2) a monthly tariff based on lighting design. Each location is billed according to the number of faces that exist at that location.

See Appendix A for details on utility service classification and charges.





## ECM 1 –STREET LIGHTING LED RETROFIT

### INVESTIGATION

Current street lighting technologies utilize Omni-directional lamps in directional fixtures to direct light to the desired area to be illuminated. The choice of technology for the past 20 years has been the high pressure sodium fixture due to its high lumen to watt efficiency and lower lumen degradation. Light Emitting Diode (LED) street lights have made improvements in design, efficiency, life span and affordability bringing



them to the forefront of street lighting technologies. LED lights also provide a higher Color Rendering Index (CRI) than high pressure sodium lamps which enables the human eye to perceive colors better at night, increasing visibility and safety. The investigation focuses on the energy efficiency, operation and maintenance savings that can be achieved for the city under current street lighting tariffs.

### *Existing System*



The City of Beacon has one thousand four hundred and fifty-two (1,452) streetlights under the Central Hudson Gas and Electric (CHG&E) street lighting tariff, as shown on the monthly street lighting utility bill from CH&G. The street lights are not metered and are regulated under Service Classification No. 8 (SC-8). Of these lights, thirty-six (36) are owned and maintained by the city (Rate C), the City owns while CH&G maintains approximately four hundred and two (402) of these fixtures (Rate B), and the remaining one thousand fourteen (1014) fixtures are owned and maintained by CHG&E (Rate A). Currently the fixtures under Rates C and B are the only fixtures that can take advantage of the energy saving benefits of an LED retrofit, as they are owned by the City of Beacon. Also the City is currently charged a maintenance fee for the Rate A and B fixtures, while the Rate C fixtures are not. Discussions with CHG&E about the lights under Rate A and B have produced a Street Lighting Conversion Attachment Agreement that provides a conversion path of the existing Rate A and B lights to Rate C. This conversion of both Rates A and B to Rate C would allow the City to take advantage of the energy savings benefits of an LED Retrofit, as well as savings from no longer being charged maintenance charges for the street light fixtures. This agreement can be found in Appendix B and outlines the terms and conditions in which the City may purchase the Rate A fixtures

from CHG&E as well as convert Rate A and B fixtures to Rate C . This study will determine whether the cost to purchase the Rate A fixtures along with the conversion of the Rate A and B fixtures to Rate C is economically beneficial to the City.



The existing lighting is comprised of a combination of cobra head, and decorative acorn or post top fixtures with photocells. Most of the lamp types are high pressure sodium or mercury vapor with some metal halide. Lamp wattages range from 70 to 400 watts. See calculation at the end of this section for existing quantities of each fixture type and wattage.

During the investigation a survey of each street light was performed to visibly check for fixture type, lamp type and wattage, as well as pole type and condition. During the survey physical defects were also noted of the lights and the city-owned poles. Damaged City Owned poles and equipment will be reported to the City. The City will repair any damaged poles or equipment under their current operating budget or elect to use contingency on the project to repair the poles. Damaged CHG&E poles and equipment will be reported to CHG&E.

### *Proposed System*

It is proposed to retrofit all existing Rate A, Rate B, and Rate C street lighting fixtures from HID to LED Fixtures. See calculation at the end of this section for proposed quantities of each fixture type and wattage. The proposed system would retrofit all existing styles of HID lights to LED fixtures while maintaining as close to existing lighting conditions as allowable within good design practices. It is also proposed to negotiate with Central Hudson Gas and Electric to buy-back the Rate A fixtures, and convert both the Rate A and Rate B fixtures to city-owned Rate C fixtures. The City would assume the responsibility of maintaining the whole street lighting fleet. This in turn would allow the city to capitalize on smaller annual utility fees and the longer life of the LED lights. The savings in the annual utility charge and maintenance costs will more than offset the costs to buy back the Rate A fixtures and assume the additional annual cost for the City to maintain the Rate A and B fixtures after they're converted to Rate C.

Energy savings were calculated based on the existing HID fixture wattage and proposed fixture wattage displayed in the calculations. Operational & maintenance savings will also be realized due to the longer

life LED fixtures and reduced costs for City to maintain the lights versus the current annual utility charges to lease and maintain the Rate A and Rate B street lights. Proposed maintenance costs assume that the City would use a qualified electrical contractor for the newly converted lights.

Cost estimates were developed through budgetary pricing from local electrical contractors, as well as multiple manufacturers for specific LED fixtures. See Appendix D for typical cut-sheets. Cost estimates also include an extra fixture stock of 3% for ease of replacement during the warranty period (10 year warranty on all new fixtures). As part of the LED conversion, CHG&E requires that a database of installed fixtures along with GPS coordinates be provided at the completion of the project. In order to meet this requirement and assist the City with asset management of the fleet of lights, costs are included for City to purchase and maintain a GIS based asset management system and software.

## **RECOMMENDATIONS**

Based on the findings of this analysis, Wendel recommends that the City purchase the existing Rate A fixtures, and through the attachment agreement convert the Rate A and Rate B fixtures to Rate C City owned and Maintained fixtures. After all fixtures are converted to Rate C it is then recommended to retrofit the entire fleet of street lights to energy efficient LED lights. Converting all street lighting fixtures to LED will result in significant energy savings, as well as the substantial maintenance savings associated with this measure over the expected life of the equipment.

# City of Beacon Street Lighting LED Retrofit

Project No. 447103

Date. 2/3/16

ECM No. 1

Measure Summary		
Energy Savings		
Total Demand Savings	218.52	kW/Year
Electrical Energy Savings	819,914	kWh/Year
Fossil Fuel Savings	-	mmBtu/Year
Cost Savings		
Electrical Dollar Savings	\$ 63,961.85	Per Year
Annual Fee Savings	\$ 178,510.34	Per Year
Average Annual Maintenance Cost	\$ 32,678.89	Per Year
Total Dollar Savings	\$ 209,793.29	Per Year
Direct Project Costs		
Material Cost	\$1,004,795	
Labor Cost	\$552,878	
<b>Total Measure Cost</b>	<b>\$1,557,673</b>	
Payback		
Simple Payback	7.4 Year(s)	

## Measure % Savings In System Energy Usage

### Electricity

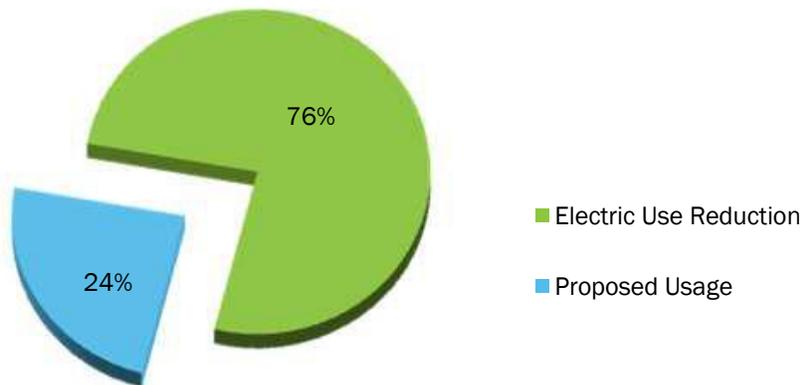

A B C			D E F G H I J K L M N									O P Q R S T U V W						X Y Z AA AB											
Qty	Fixture Type	Hours/Year	Existing									Proposed						Savings											
			Lamp Lumens	Lamp Wattage	Lamp Type	Fixture Wattage	Total kW	Annual kWh per fixture	Annual kWh Billed	Annual Energy Costs	CHGE Maint. Costs per fixture	Annual Utility Charges	Total Annual Cost	Qty	Fixture Type	Fixture Lumens	LED Fixture Wattage	Total kW	CHGE Billed Wattage (Tariff)	Annual kWh Billed	Annual Energy Costs	Annual CHGE cost per fixture *	Annual Utility Charges	Total Annual Cost	Annual kWh Savings	Annual kW Savings	Annual Utility Charge Savings	Annual Energy Savings	Total Annual Savings
			Lumens	Watts		Watts	kW	kWh	kWh/Year	\$/Year	\$/Year/Fixture	\$/Year	\$/Year	\$/Year	\$/Year	Lumens	Watts	kW	kW	kWh/Year	\$/Year	\$/Year/Fixture	\$/Year	\$/Year	\$/Year	\$/Year	\$/Year	\$/Year	\$/Year
Standard			Standard									Standard						Standard											
431	Cobra Head	3,802.4	5,800	70	High Pressure Sodium	86	37.07	327	140,939	\$ 12,403	\$ 149.24	\$ 64,322	\$ 76,725	467	Cobra Head	2,887	24	11.21	25	40,971	\$ 3,907	\$ 13.11	\$ 6,122.37	\$ 10,029	99,968	25.86	\$ 58,200	\$ 8,496	\$ 66,696
111	Cobra Head	3,802.4	16,000	150	High Pressure Sodium	180	19.98	684	75,971	\$ 6,685	\$ 165.87	\$ 18,412	\$ 25,097	111	Cobra Head	8,140	73	8.10	75	31,655	\$ 2,786	\$ 20.83	\$ 2,312.13	\$ 5,098	44,317	11.88	\$ 16,099	\$ 3,900	\$ 19,999
98	Cobra Head	3,802.4	27,000	250	High Pressure Sodium	316	30.97	1,202	117,752	\$ 10,362	\$ 201.10	\$ 19,708	\$ 30,070	98	Cobra Head	16,046	137	13.43	135	50,305	\$ 4,427	\$ 31.09	\$ 3,046.38	\$ 7,473	67,447	17.54	\$ 16,661	\$ 5,935	\$ 22,597
5	Cobra Head	3,802.4	50,000	400	High Pressure Sodium	496	2.48	1,886	9,430	\$ 830	\$ 226.79	\$ 1,134	\$ 1,964	4	Cobra Head	28,102	248	0.99	245	4,658	\$ 328	\$ 48.37	\$ 193.49	\$ 521	4,772	1.49	\$ 940	\$ 502	\$ 1,442
Non Standard			Non Standard									Non Standard						Non Standard											
15	Cobra Head	3,802.4	3,600	100	Mercury Vapor	126	2	479	7,186	\$ 632	\$ 153.30	\$ 2,300	\$ 2,932	17	Cobra Head	2,887	24	0.41	25	1,426	\$ 142	\$ 13.11	\$ 222.87	\$ 365	5,761	1.48	\$ 2,077	\$ 490	\$ 2,567
324	Cobra Head	3,802.4	7,000	175	Mercury Vapor	208	67.39	791	256,250	\$ 22,550	\$ 166.02	\$ 53,790	\$ 76,340	257	Cobra Head	4,030	36	9.25	35	43,119	\$ 3,010	\$ 14.66	\$ 3,767.62	\$ 6,777	213,131	58.14	\$ 50,023	\$ 19,540	\$ 69,563
2	Cobra Head	3,802.4	11,000	250	Mercury Vapor	296	0.59	1,126	2,251	\$ 198	\$ 180.09	\$ 360	\$ 558	3	Cobra Head	5,550	54	0.16	55	418	\$ 55	\$ 17.74	\$ 53.22	\$ 108	1,833	0.43	\$ 307	\$ 143	\$ 450
4	Cobra Head	3,802.4	15,000	400	Mercury Vapor	455	1.82	1,730	6,920	\$ 609	\$ 210.12	\$ 840	\$ 1,449		Cobra Head	12,222	106	-	105	1,597	\$ -	\$ 25.47	\$ -	\$ -	5,323	1.82	\$ 840	\$ 609	\$ 1,449
9	Cobra Head	3,802.4	20,000	400	Mercury Vapor	455	4	1,730	15,571	\$ 1,370	\$ 210.12	\$ 1,891	\$ 3,261	3	Cobra Head	12,222	106	0.32	105	3,593	\$ 105	\$ 25.47	\$ 76.41	\$ 182	11,977	3.78	\$ 1,815	\$ 1,265	\$ 3,079
Decorative & Special Purpose Luminaries			Decorative & Special Purpose Luminaries									Decorative & Special Purpose Luminaries						Decorative & Special Purpose Luminaries											
9	Acorn Dec.	3,802.4	5,800	70	High Pressure Sodium	86	0.77	327	2,943	\$ 258.99	\$ 322.92	\$ 2,906.28	\$ 3,165.27							\$ -	\$ -	\$ -	\$ -	\$ -	\$ -	\$ -	\$ -	\$ -	
3	Victorian Gaslight	3,802.4	16,000	150	High Pressure Sodium	180	0.54	684	2,053	\$ 180.69	\$ 243.29	\$ 729.87	\$ 910.56								\$ -	\$ -	\$ -	\$ -	\$ -	\$ -	\$ -	\$ -	\$ -
2	Highway Setback	3,802.4	27,000	250	High Pressure Sodium	316	0.63	1,202	2,403	\$ 211.47	\$ 230.85	\$ 461.70	\$ 673.17								\$ -	\$ -	\$ -	\$ -	\$ -	\$ -	\$ -	\$ -	\$ -
1	Highway Setback	3,802.4	36,000	400	Metal Halide	464	0.46	1,764	1,764	\$ 155.26	\$ 257.57	\$ 257.57	\$ 412.83								\$ -	\$ -	\$ -	\$ -	\$ -	\$ -	\$ -	\$ -	\$ -
<b>1,014</b>							<b>168.69</b>		<b>641,434</b>	<b>\$ 56,446</b>		<b>\$ 167,113</b>	<b>\$ 223,559</b>	<b>960</b>				<b>44</b>		<b>177,742</b>	<b>\$ 14,760</b>		<b>\$ 15,794</b>	<b>\$ 30,554</b>	<b>463,692</b>	<b>124.82</b>	<b>\$ 151,318</b>	<b>\$ 41,687</b>	<b>\$ 193,005</b>

\* Includes Fee for Demand side of Fixture and \$6.39 for annual attachment fee per fixture.

\*\* Includes Pre-attachment Survey Fee of \$8.18 per fixture.



A	B	C	D	E	F	G	H	I	J	K	L	M	N
Existing Unmetered (listed on Bills)													
Qty	Fixture Type	Hours per Year	Lamp Lumens	Lamp Wattage	Lamp Type	Fixture Wattage	Total kW	Annual kWh per fixture	Annual kWh billed	Existing Energy Costs	CHGE Maint. Cost per Fixture	Annual Utility Charges	Total Annual Costs
			Lumens	Watts		Watts	kW	kWh	kWh/Year	\$/Year	\$/Year/Fixture	\$/Year	\$/Year
Standard													
8	Cobra Head	3,802.4	16,000	150	High Pressure Sodium	180	1.44	684	5,475	\$ 481.84	\$ 37.05	\$ 296.40	\$ 778.24
4	Cobra Head	3,802.4	27,000	250	High Pressure Sodium	316	1.26	1,202	4,806	\$ 422.95	\$ 58.06	\$ 232.24	\$ 655.19
10	Cobra Head	3,802.4	14,000	175	Metal Halide	205	2.05	779	7,795	\$ 685.95	\$ 40.93	\$ 409.30	\$ 1,095.25
14	Cobra Head	3,802.4	20,500	250	Metal Halide	300	4.20	1,141	15,970	\$ 1,405.36	\$ 55.59	\$ 778.26	\$ 2,183.62
	Acorn	3,802.4	14,000	175	Metal Halide	205	-	779	-	\$ -	\$ 40.93	\$ -	\$ -
	Shoe Box	3,802.4	20,500	250	Metal Halide	300	-	1,141	-	\$ -	\$ 55.59	\$ -	\$ -
<b>36</b>							<b>8.95</b>		<b>34,046</b>	<b>\$ 2,996.09</b>		<b>\$ 1,716.20</b>	<b>\$ 4,712.29</b>

\* Includes Fee for Demand side of Fixture and \$6.39 for annual attachment fee per fixture.  
 \*\* Includes Pre-attachment Survey Fee of \$8.18 per fixture.

A	O	P	Q	R	S	T	U	V	W	X	Y	Z	AA	AB	
Proposed										Savings					
Qty	Fixture Type	Fixture Lumens	LED Fixture Wattage	Total kW	CHE Billed Wattage (Tariff)	Annual kWh Billed	Annual Energy Costs	Annual CHGE cost Per Fixture*	Annual Utility Charges	Total Annual Costs	Annual kWh Savings	Annual kW Savings	Annual Utility Charge Savings	Annual Energy Savings	Total Annual Savings
		Lumens	Watts	kW	Watts	kWh/Year	\$/Year	\$/Year/Fixture	\$/Year	\$/Year	kWh/Year	kW/Year	\$/Year	\$/Year	\$/Year
Standard															
8	Cobra Head	8,140	73	0.58	75	2,281	\$ 200.77	\$ 20.83	\$ 166.64	\$ 367.41	3,194	0.86	\$ 129.76	\$ 281.07	\$ 410.83
4	Cobra Head	16,046	137	0.55	135	2,053	\$ 180.69	\$ 31.09	\$ 124.34	\$ 305.03	2,753	0.72	\$ 107.90	\$ 242.26	\$ 350.15
	Cobra Head	8,140	106	-	105	-	\$ -	\$ 25.47	\$ -	\$ -	7,795	2.05	\$ 409.30	\$ 685.95	\$ 1,095.25
	Cobra Head	12,222	106	-	105	-	\$ -	\$ 25.47	\$ -	\$ -	15,970	4.20	\$ 778.26	\$ 1,405.36	\$ 2,183.62
32	MetroScape	8,204	90	2.72	85	10,342	\$ 910.14	\$ 22.38	\$ 716.16	\$ 1,626.30	(10,342)	(2.72)	\$ (716.16)	\$ (910.14)	\$ (1,626.30)
17	Form 10	11,053	110	1.79	105	6,787	\$ 597.28	\$ 25.47	\$ 432.99	\$ 1,030.27	(6,787)	(1.79)	\$ (432.99)	\$ (597.28)	\$ (1,030.27)
<b>61</b>				<b>5.64</b>		<b>21,464</b>	<b>\$ 1,888.87</b>		<b>\$ 1,440.13</b>	<b>\$ 3,329.00</b>	<b>12,582</b>	<b>3.32</b>	<b>\$ 276.07</b>	<b>\$ 1,107.22</b>	<b>\$ 1,383.29</b>

\* Includes Fee for Demand side of Fixture and \$6.39 for annual attachment fee per fixture.  
 \*\* Includes Pre-attachment Survey Fee of \$8.18 per fixture.



### Rate A Maintenances Schedule

A	B	C	D	E	F	G	H	I	J	K	L	M	N	O
Average Call for Street Light Maintenance			Hours	Rate	Parts	Average LED Cost	Extra Parts	Average Call	Warranty Lights (Years)	QTY Fixtures	OHP	Maintenance Escalation		
			4	\$ 50	\$ 460.02	\$ 460.02	\$ 50.00	\$ 710.02	10	1014	30%	2%		

Private Contractor used	Cost of HID Lamp	Calls Per Year
N	\$ 200.00	

Total Annual Savings	CHGE Fee Savings	Current Maintenance Costs	Proposed Maintenance Cost	Maintenance cost savings	Energy Savings	Annual Savings	Failure Rate Year	Calls Per Year	Rate	Parts	Existing Hours/ Year	Proposed Hours/ year	Hours Saved/ Year	Cost of HID Lamp
Year 0														
1	\$ 151,318.40		\$ -	\$ -	\$ 41,686.59	\$ 193,005.00	0.0%	0	\$ 50.00	\$ 460.02	-	-	0.0	\$ 200.00
2	\$ 156,311.91		\$ 1,287.78	\$ (1,287.78)	\$ 43,062.25	\$ 198,086.38	0.5%	5	\$ 51.00	\$ 469.22	-	20.28	20.3	\$ 204.00
3	\$ 161,470.20		\$ 1,308.47	\$ (1,308.47)	\$ 44,483.30	\$ 204,645.04	0.5%	5	\$ 52.02	\$ 478.61	-	20.28	20.3	\$ 208.08
4	\$ 166,798.72		\$ 1,329.56	\$ (1,329.56)	\$ 45,951.25	\$ 211,420.41	0.5%	5	\$ 53.06	\$ 488.18	-	20.28	20.3	\$ 212.24
5	\$ 172,303.08		\$ 2,702.17	\$ (2,702.17)	\$ 47,467.65	\$ 217,068.55	1.0%	10	\$ 54.12	\$ 497.94	-	40.56	40.6	\$ 216.49
6	\$ 177,989.08		\$ 2,746.08	\$ (2,746.08)	\$ 49,034.08	\$ 224,277.08	1.0%	10	\$ 55.20	\$ 507.90	-	40.56	40.6	\$ 220.82
7	\$ 183,862.72		\$ 5,581.71	\$ (5,581.71)	\$ 50,652.20	\$ 228,933.21	2.0%	20	\$ 56.31	\$ 518.06	-	81.12	81.1	\$ 225.23
8	\$ 189,930.19		\$ 5,673.07	\$ (5,673.07)	\$ 52,323.72	\$ 236,580.84	2.0%	20	\$ 57.43	\$ 528.42	-	81.12	81.1	\$ 229.74
9	\$ 196,197.88		\$ 8,649.38	\$ (8,649.38)	\$ 54,050.41	\$ 241,598.92	3.0%	30	\$ 58.58	\$ 538.99	-	121.68	121.7	\$ 234.33
10	\$ 202,672.41		\$ 8,791.94	\$ (8,791.94)	\$ 55,834.07	\$ 249,714.54	3.0%	30	\$ 59.75	\$ 549.77	-	121.68	121.7	\$ 239.02
11	\$ 209,360.60		\$ 43,326.39	\$ (43,326.39)	\$ 57,676.60	\$ 223,710.81	5.0%	51	\$ 60.95	\$ 560.76	-	202.80	202.8	\$ 243.80
12	\$ 216,269.50		\$ 44,142.21	\$ (44,142.21)	\$ 59,579.92	\$ 231,707.21	5.0%	51	\$ 62.17	\$ 571.98	-	202.80	202.8	\$ 248.67
13	\$ 223,406.40		\$ 44,974.36	\$ (44,974.36)	\$ 61,546.06	\$ 239,978.10	5.0%	51	\$ 63.41	\$ 583.42	-	202.80	202.8	\$ 253.65
14	\$ 230,778.81		\$ 45,823.15	\$ (45,823.15)	\$ 63,577.08	\$ 248,532.74	5.0%	51	\$ 64.68	\$ 595.09	-	202.80	202.8	\$ 258.72
15	\$ 238,394.51		\$ 46,688.91	\$ (46,688.91)	\$ 65,675.12	\$ 257,380.73	5.0%	51	\$ 65.97	\$ 606.99	-	202.80	202.8	\$ 263.90
16	\$ 246,261.53		\$ 47,571.99	\$ (47,571.99)	\$ 67,842.40	\$ 266,531.94	5.0%	51	\$ 67.29	\$ 619.13	-	202.80	202.8	\$ 269.17
17	\$ 254,388.16		\$ 48,472.73	\$ (48,472.73)	\$ 70,081.20	\$ 275,996.63	5.0%	51	\$ 68.64	\$ 631.51	-	202.80	202.8	\$ 274.56
18	\$ 262,782.97		\$ 49,391.48	\$ (49,391.48)	\$ 72,393.88	\$ 285,785.37	5.0%	51	\$ 70.01	\$ 644.14	-	202.80	202.8	\$ 280.05
19	\$ 271,454.81		\$ 50,328.61	\$ (50,328.61)	\$ 74,782.88	\$ 295,909.08	5.0%	51	\$ 71.41	\$ 657.03	-	202.80	202.8	\$ 285.65
20	\$ 280,412.81		\$ 51,284.48	\$ (51,284.48)	\$ 77,250.72	\$ 306,379.05	5.0%	51	\$ 72.84	\$ 670.17	-	202.80	202.8	\$ 291.36
21	\$ 289,666.44		\$ 52,259.47	\$ (52,259.47)	\$ 79,799.99	\$ 317,206.95	5.0%	51	\$ 74.30	\$ 683.57	-	202.80	202.8	\$ 297.19
22	\$ 299,225.43		\$ 53,253.96	\$ (53,253.96)	\$ 82,433.39	\$ 328,404.86	5.0%	51	\$ 75.78	\$ 697.24	-	202.80	202.8	\$ 303.13
23	\$ 309,099.87		\$ 54,268.34	\$ (54,268.34)	\$ 85,153.69	\$ 339,985.22	5.0%	51	\$ 77.30	\$ 711.19	-	202.80	202.8	\$ 309.20
24	\$ 319,300.17		\$ 55,303.01	\$ (55,303.01)	\$ 87,963.76	\$ 351,960.92	5.0%	51	\$ 78.84	\$ 725.41	-	202.80	202.8	\$ 315.38
25	\$ 329,837.07		\$ 56,358.37	\$ (56,358.37)	\$ 90,866.57	\$ 364,345.27	5.0%	51	\$ 80.42	\$ 739.92	-	202.80	202.8	\$ 321.69
26	\$ 340,721.69		\$ 57,434.84	\$ (57,434.84)	\$ 93,865.16	\$ 377,152.02	5.0%	51	\$ 82.03	\$ 754.72	-	202.80	202.8	\$ 328.12
27	\$ 351,965.51		\$ 58,532.83	\$ (58,532.83)	\$ 96,962.71	\$ 390,395.39	5.0%	51	\$ 83.67	\$ 769.81	-	202.80	202.8	\$ 334.68
28	\$ 363,580.37		\$ 59,652.79	\$ (59,652.79)	\$ 100,162.48	\$ 404,090.07	5.0%	51	\$ 85.34	\$ 785.21	-	202.80	202.8	\$ 341.38
29	\$ 375,578.52		\$ 60,795.15	\$ (60,795.15)	\$ 103,467.85	\$ 418,251.22	5.0%	51	\$ 87.05	\$ 800.91	-	202.80	202.8	\$ 348.20
30	\$ 387,972.62		\$ 61,960.35	\$ (61,960.35)	\$ 106,882.28	\$ 432,894.55	5.0%	51	\$ 88.79	\$ 816.93	-	202.80	202.8	\$ 355.17
31	\$ 400,775.71		\$ 63,148.86	\$ (63,148.86)	\$ 110,409.40	\$ 448,036.26	5.0%	51	\$ 90.57	\$ 833.27	-	202.80	202.8	\$ 362.27
<b>Total</b>	<b>\$ 7,960,088.10</b>	<b>\$ -</b>	<b>\$ 1,143,042.43</b>	<b>\$ (1,143,042.43)</b>	<b>\$ 2,192,918.69</b>	<b>\$ 9,009,964.36</b>	<b>119%</b>	<b>1202</b>						

### Rate B Maintenances Schedule

A	B	C	D	E	F	G	H	I	J	K	L	M	N	O
Average Call for Street Light Maintenance			Hours	Rate	Parts	Average LED Cost	Extra Parts	Average Call	Warranty Lights (Years)	QTY Fixtures	OHP	Maintenance Escalation		
			4	\$ 50	\$ 460.02	\$ 460.02	\$ 50.00	\$ 710.02	10	411	30%	2%		

Private Contractor used	Cost of HID Lamp	Calls Last Year
N	\$ 200.00	

Total Annual Savings	CHGE Fee Savings	Current Maintenance Costs	Proposed Maintenance Cost	Maintenance cost savings	Energy Savings	Annual Savings	Failure Rate Year	Calls Per Year	Rate	Parts	Existing Hours/ Year	Proposed Hours/ year	Hours Saved/ Year	Cost of HID Lamp
Year 0														
1	\$ 26,915.87		\$ -	\$ -	\$ 21,168.03	\$ 48,083.90	0.0%	0	\$ 50.00	\$ 460.02	-	-	0.0	\$ 200.00
2	\$ 27,804.09		\$ 521.97	\$ (521.97)	\$ 21,866.58	\$ 49,148.70	0.5%	2	\$ 51.00	\$ 469.22	-	8.22	8.2	\$ 204.00
3	\$ 28,721.63		\$ 530.35	\$ (530.35)	\$ 22,588.18	\$ 50,779.45	0.5%	2	\$ 52.02	\$ 478.61	-	8.22	8.2	\$ 208.08
4	\$ 29,669.44		\$ 538.91	\$ (538.91)	\$ 23,333.59	\$ 52,464.12	0.5%	2	\$ 53.06	\$ 488.18	-	8.22	8.2	\$ 212.24
5	\$ 30,648.53		\$ 1,095.26	\$ (1,095.26)	\$ 24,103.60	\$ 53,656.87	1.0%	4	\$ 54.12	\$ 497.94	-	16.44	16.4	\$ 216.49
6	\$ 31,659.93		\$ 1,113.05	\$ (1,113.05)	\$ 24,899.01	\$ 55,445.89	1.0%	4	\$ 55.20	\$ 507.90	-	16.44	16.4	\$ 220.82
7	\$ 32,704.71		\$ 2,262.41	\$ (2,262.41)	\$ 25,720.68	\$ 56,162.98	2.0%	8	\$ 56.31	\$ 518.06	-	32.88	32.9	\$ 225.23
8	\$ 33,783.97		\$ 2,299.44	\$ (2,299.44)	\$ 26,569.46	\$ 58,053.99	2.0%	8	\$ 57.43	\$ 528.42	-	32.88	32.9	\$ 229.74
9	\$ 34,898.84		\$ 3,505.81	\$ (3,505.81)	\$ 27,446.26	\$ 58,839.28	3.0%	12	\$ 58.58	\$ 538.99	-	49.32	49.3	\$ 234.33
10	\$ 36,050.50		\$ 3,563.60	\$ (3,563.60)	\$ 28,351.98	\$ 60,838.88	3.0%	12	\$ 59.75	\$ 549.77	-	49.32	49.3	\$ 239.02
11	\$ 37,240.16		\$ 17,561.29	\$ (17,561.29)	\$ 29,287.60	\$ 48,966.47	5.0%	21	\$ 60.95	\$ 560.76	-	82.20	82.2	\$ 243.80
12	\$ 38,469.09		\$ 17,891.96	\$ (17,891.96)	\$ 30,254.09	\$ 50,831.22	5.0%	21	\$ 62.17	\$ 571.98	-	82.20	82.2	\$ 248.67
13	\$ 39,738.57		\$ 18,229.25	\$ (18,229.25)	\$ 31,252.47	\$ 52,761.79	5.0%	21	\$ 63.41	\$ 583.42	-	82.20	82.2	\$ 253.65
14	\$ 41,049.94		\$ 18,573.29	\$ (18,573.29)	\$ 32,283.81	\$ 54,760.46	5.0%	21	\$ 64.68	\$ 595.09	-	82.20	82.2	\$ 258.72
15	\$ 42,404.59		\$ 18,924.20	\$ (18,924.20)	\$ 33,349.17	\$ 56,829.56	5.0%	21	\$ 65.97	\$ 606.99	-	82.20	82.2	\$ 263.90
16	\$ 43,803.94		\$ 19,282.14	\$ (19,282.14)	\$ 34,449.69	\$ 58,971.50	5.0%	21	\$ 67.29	\$ 619.13	-	82.20	82.2	\$ 269.17
17	\$ 45,249.47		\$ 19,647.23	\$ (19,647.23)	\$ 35,586.53	\$ 61,188.78	5.0%	21	\$ 68.64	\$ 631.51	-	82.20	82.2	\$ 274.56
18	\$ 46,742.70		\$ 20,019.62	\$ (20,019.62)	\$ 36,760.89	\$ 63,483.97	5.0%	21	\$ 70.01	\$ 644.14	-	82.20	82.2	\$ 280.05
19	\$ 48,285.21		\$ 20,399.47	\$ (20,399.47)	\$ 37,974.00	\$ 65,859.75	5.0%	21	\$ 71.41	\$ 657.03	-	82.20	82.2	\$ 285.65
20	\$ 49,878.63		\$ 20,786.91	\$ (20,786.91)	\$ 39,227.14	\$ 68,318.86	5.0%	21	\$ 72.84	\$ 670.17	-	82.20	82.2	\$ 291.36
21	\$ 51,524.62		\$ 21,182.09	\$ (21,182.09)	\$ 40,521.64	\$ 70,864.16	5.0%	21	\$ 74.30	\$ 683.57	-	82.20	82.2	\$ 297.19
22	\$ 53,224.93		\$ 21,585.19	\$ (21,585.19)	\$ 41,858.85	\$ 73,498.60	5.0%	21	\$ 75.78	\$ 697.24	-	82.20	82.2	\$ 303.13
23	\$ 54,981.36		\$ 21,996.34	\$ (21,996.34)	\$ 43,240.19	\$ 76,225.21	5.0%	21	\$ 77.30	\$ 711.19	-	82.20	82.2	\$ 309.20
24	\$ 56,795.74		\$ 22,415.72	\$ (22,415.72)	\$ 44,667.12	\$ 79,047.14	5.0%	21	\$ 78.84	\$ 725.41	-	82.20	82.2	\$ 315.38
25	\$ 58,670.00		\$ 22,843.48	\$ (22,843.48)	\$ 46,141.13	\$ 81,967.65	5.0%	21	\$ 80.42	\$ 739.92	-	82.20	82.2	\$ 321.69
26	\$ 60,606.11		\$ 23,279.80	\$ (23,279.80)	\$ 47,663.79	\$ 84,990.10	5.0%	21	\$ 82.03	\$ 754.72	-	82.20	82.2	\$ 328.12
27	\$ 62,606.11		\$ 23,724.85	\$ (23,724.85)	\$ 49,236.70	\$ 88,117.96	5.0%	21	\$ 83.67	\$ 769.81	-	82.20	82.2	\$ 334.68
28	\$ 64,672.11		\$ 24,178.79	\$ (24,178.79)	\$ 50,861.51	\$ 91,354.83	5.0%	21	\$ 85.34	\$ 785.21	-	82.20	82.2	\$ 341.38
29	\$ 66,806.29		\$ 24,641.82	\$ (24,641.82)	\$ 52,539.94	\$ 94,704.41	5.0%	21	\$ 87.05	\$ 800.91	-	82.20	82.2	\$ 348.20
30	\$ 69,010.90		\$ 25,114.11	\$ (25,114.11)	\$ 54,273.75	\$ 98,170.55	5.0%	21	\$ 88.79	\$ 816.93	-	82.20	82.2	\$ 355.17
31	\$ 71,288.26		\$ 25,595.84	\$ (25,595.84)	\$ 56,064.79	\$ 101,757.21	5.0%	21	\$ 90.57	\$ 833.27	-	82.20	82.2	\$ 362.27
<b>Total</b>	<b>\$ 1,415,906.25</b>	<b>\$ -</b>	<b>\$ 463,304.18</b>	<b>\$ (463,304.18)</b>	<b>\$ 1,113,542.15</b>	<b>\$ 2,066,144.22</b>	<b>119%</b>	<b>487</b>						

### Rate C Maintenances Schedule

A	B	C	D	E	F	G	H	I	J	K	L	M	N	O
Average Call for Street Light Maintenance			Hours	Rate	Parts	Average LED Cost	Extra Parts	Average Call	Warranty Lights (Years)	QTY Fixtures	OHP	Maintenance Escalation		
			4	\$ 104	\$ 460.02	\$ 460.02	\$ 50.00	\$ 926.02	10	36	30%	2%		

Private Contractor used	Cost of HID Lamp	Calls Last Year
N	\$ 69.35	7.44

Total Annual Savings	CHGE Fee Savings	Current Maintenance Costs	Proposed Maintenance Cost	Maintenance cost savings	Energy Savings	Annual Savings	Failure Rate Year	Calls Per Year	Rate	Parts	Existing Hours/ Year	Proposed Hours/ year	Hours Saved/ Year	Cost of HID Lamp
Year 0														
1	\$ 276.07	\$ 3,611.04	\$ -	\$ 3,611.04	\$ 1,107.22	\$ 4,994.33	0.0%	0	\$ 104.00	\$ 460.02	29.76	-	29.8	\$ 69.35
2	\$ 285.18	\$ 3,683.26	\$ 85.38	\$ 3,597.88	\$ 1,143.76	\$ 5,026.82	0.5%	0	\$ 106.08	\$ 469.22	29.76	0.72	29.0	\$ 70.74
3	\$ 294.59	\$ 3,756.93	\$ 86.91	\$ 3,670.02	\$ 1,181.50	\$ 5,146.11	0.5%	0	\$ 108.20	\$ 478.61	29.76	0.72	29.0	\$ 72.16
4	\$ 304.31	\$ 3,832.06	\$ 88.46	\$ 3,743.60	\$ 1,220.49	\$ 5,268.40	0.5%	0	\$ 110.37	\$ 488.18	29.76	0.72	29.0	\$ 73.60
5	\$ 314.35	\$ 3,908.71	\$ 180.11	\$ 3,728.60	\$ 1,260.77	\$ 5,303.72	1.0%	0	\$ 112.57	\$ 497.94	29.76	1.44	28.3	\$ 75.07
6	\$ 324.73	\$ 3,986.88	\$ 183.35	\$ 3,803.53	\$ 1,302.37	\$ 5,430.63	1.0%	0	\$ 114.82	\$ 507.90	29.76	1.44	28.3	\$ 76.57
7	\$ 335.44	\$ 4,066.62	\$ 373.31	\$ 3,693.31	\$ 1,345.35	\$ 5,374.10	2.0%	1	\$ 117.12	\$ 518.06	29.76	2.88	26.9	\$ 78.10
8	\$ 346.51	\$ 4,147.95	\$ 380.05	\$ 3,767.90	\$ 1,389.75	\$ 5,504.16	2.0%	1	\$ 119.46	\$ 528.42	29.76	2.88	26.9	\$ 79.67
9	\$ 357.95	\$ 4,230.91	\$ 580.40	\$ 3,650.51	\$ 1,435.61	\$ 5,444.06	3.0%	1	\$ 121.85	\$ 538.99	29.76	4.32	25.4	\$ 81.26
10	\$ 369.76	\$ 4,315.53	\$ 590.93	\$ 3,724.60	\$ 1,482.99	\$ 5,577.34	3.0%	1	\$ 124.29	\$ 549.77	29.76	4.32	25.4	\$ 82.89
11	\$ 381.96	\$ 4,401.84	\$ 2,012.16	\$ 2,389.68	\$ 1,531.93	\$ 4,303.56	5.0%	2	\$ 126.78	\$ 560.76	29.76	7.20	22.6	\$ 84.54
12	\$ 394.57	\$ 4,489.87	\$ 2,050.60	\$ 2,439.27	\$ 1,582.48	\$ 4,416.32	5.0%	2	\$ 129.31	\$ 571.98	29.76	7.20	22.6	\$ 86.23
13	\$ 407.59	\$ 4,579.67	\$ 2,089.82	\$ 2,489.86	\$ 1,634.70	\$ 4,532.14	5.0%	2	\$ 131.90	\$ 583.42	29.76	7.20	22.6	\$ 87.96
14	\$ 421.04	\$ 4,671.27	\$ 2,129.81	\$ 2,541.45	\$ 1,688.65	\$ 4,651.14	5.0%	2	\$ 134.54	\$ 595.09	29.76	7.20	22.6	\$ 89.72
15	\$ 434.93	\$ 4,764.69	\$ 2,170.61	\$ 2,594.08	\$ 1,744.37	\$ 4,773.38	5.0%	2	\$ 137.23	\$ 606.99	29.76	7.20	22.6	\$ 91.51
16	\$ 449.28	\$ 4,859.98	\$ 2,212.22	\$ 2,647.76	\$ 1,801.94	\$ 4,898.98	5.0%	2	\$ 139.97	\$ 619.13	29.76	7.20	22.6	\$ 93.34
17	\$ 464.11	\$ 4,957.18	\$ 2,254.66	\$ 2,702.52	\$ 1,861.40	\$ 5,028.03	5.0%	2	\$ 142.77	\$ 631.51	29.76	7.20	22.6	\$ 95.21
18	\$ 479.43	\$ 5,056.33	\$ 2,297.96	\$ 2,758.37	\$ 1,922.83	\$ 5,160.62	5.0%	2	\$ 145.63	\$ 644.14	29.76	7.20	22.6	\$ 97.11
19	\$ 495.25	\$ 5,157.45	\$ 2,342.12	\$ 2,815.34	\$ 1,986.28	\$ 5,296.86	5.0%	2	\$ 148.54	\$ 657.03	29.76	7.20	22.6	\$ 99.06
20	\$ 511.59	\$ 5,260.60	\$ 2,387.16	\$ 2,873.44	\$ 2,051.83	\$ 5,436.86	5.0%	2	\$ 151.51	\$ 670.17	29.76	7.20	22.6	\$ 101.04
21	\$ 528.47	\$ 5,365.82	\$ 2,433.10	\$ 2,932.71	\$ 2,119.54	\$ 5,580.72	5.0%	2	\$ 154.54	\$ 683.57	29.76	7.20	22.6	\$ 103.06
22	\$ 545.91	\$ 5,473.13	\$ 2,479.96	\$ 2,993.17	\$ 2,189.48	\$ 5,728.56	5.0%	2	\$ 157.63	\$ 697.24	29.76	7.20	22.6	\$ 105.12
23	\$ 563.93	\$ 5,582.59	\$ 2,527.76	\$ 3,054.83	\$ 2,261.73	\$ 5,880.49	5.0%	2	\$ 160.78	\$ 711.19	29.76	7.20	22.6	\$ 107.22
24	\$ 582.54	\$ 5,694.25	\$ 2,576.52	\$ 3,117.73	\$ 2,336.37	\$ 6,036.63	5.0%	2	\$ 164.00	\$ 725.41	29.76	7.20	22.6	\$ 109.37
25	\$ 601.76	\$ 5,808.13	\$ 2,626.25	\$ 3,181.88	\$ 2,413.47	\$ 6,197.11	5.0%	2	\$ 167.28	\$ 739.92	29.76	7.20	22.6	\$ 111.55
26	\$ 621.62	\$ 5,924.29	\$ 2,676.97	\$ 3,247.32	\$ 2,493.12	\$ 6,362.05	5.0%	2	\$ 170.62	\$ 754.72	29.76	7.20	22.6	\$ 113.78
27	\$ 642.13	\$ 6,042.78	\$ 2,728.71	\$ 3,314.07	\$ 2,575.39	\$ 6,531.59	5.0%	2	\$ 174.04	\$ 769.81	29.76	7.20	22.6	\$ 116.06
28	\$ 663.32	\$ 6,163.64	\$ 2,781.49	\$ 3,382.15	\$ 2,660.38	\$ 6,705.85	5.0%	2	\$ 177.52	\$ 785.21	29.76	7.20	22.6	\$ 118.38
29	\$ 685.21	\$ 6,286.91	\$ 2,835.32	\$ 3,451.59	\$ 2,748.17	\$ 6,884.97	5.0%	2	\$ 181.07	\$ 800.91	29.76	7.20	22.6	\$ 120.75
30	\$ 707.82	\$ 6,412.65	\$ 2,890.22	\$ 3,522.42	\$ 2,838.86	\$ 7,069.10	5.0%	2	\$ 184.69	\$ 816.93	29.76	7.20	22.6	\$ 123.16
31	\$ 731.18	\$ 6,540.90	\$ 2,946.23	\$ 3,594.67	\$ 2,932.54	\$ 7,258.39	5.0%	2	\$ 188.38	\$ 833.27	29.76	7.20	22.6	\$ 125.63
<b>Total</b>	<b>\$ 14,522.52</b>	<b>\$ 153,033.86</b>	<b>\$ 53,998.55</b>	<b>\$ 99,035.30</b>	<b>\$ 58,245.25</b>	<b>\$ 171,803.07</b>	<b>119%</b>	<b>43</b>						

**MATERIAL & LABOR COST ESTIMATE STREET LIGHTING**

**WENDEL**

Project : City of Beacon  
 Project # : 447103  
 Measure : Street Lighting LED Retrofit  
 Date : 02/03/16

Estimated by: SDM  
 Checked by: JGD  
 Approved by: DI  
 File: Cost Estimate

Item No.	Description			Qty.	Unit	Material		Labor		Total Cost Labor & Material
						Unit Price	Total	Unit Price	Total	
1	Mobilization/demobilization to include attendance of all necessary project preconstruction/planning meetings, development of project mailings, establishment of customer contact database, and overall upfront project support.			1	Each	\$0	\$0	\$10,500	\$10,500	\$10,500
2	Cobra Head	LED	25W-4000K-TYPE II-Photocell	484	Each	\$196	\$94,864	\$592	\$286,624	\$381,488
3	Cobra Head	LED	72-4000K-TYPE II-Photocell	208	Each	\$260	\$54,080	\$592	\$123,177	\$177,257
4	Cobra Head	LED	145W-4000K-TYPE II-Photocell	191	Each	\$468	\$89,388	\$592	\$113,110	\$202,498
5	Cobra Head	LED	241W-4000K-TYPE II-Photocell	4	Each	\$590	\$2,360	\$592	\$2,369	\$4,729
6	Cobra Head	LED	35W-4000K-TYPE II-Photocell	257	Each	\$196	\$50,372	\$592	\$152,195	\$202,567
7	Cobra Head	LED	54W-4000K-TYPE II-Photocell	3	Each	\$260	\$780	\$592	\$1,777	\$2,557
8	Cobra Head	LED	108W-4000K-TYPE II-Photocell	3	Each	\$335	\$1,005	\$592	\$1,777	\$2,782
9	Post Top	LED	90W-4000K-TYPE II-Photocell-BLACK	92	Each	\$1,434	\$131,928	\$652	\$60,002	\$191,930
10	Post Top	LED	35W-4000K-TYPE II-Photocell-BLACK	62	Each	\$1,215	\$75,330	\$652	\$40,436	\$115,766
11	Post Top	LED	135W-4000K-TYPE II-Photocell-BLACK	52	Each	\$1,318	\$68,536	\$652	\$33,914	\$102,450
12	Post Top	LED	48W-4000K-TYPE II-Photocell-BLACK	11	Each	\$1,215	\$13,365	\$652	\$7,174	\$20,539
13	Flood Light	LED	213W-4000K-TYPE V-Photocell-BLACK	7	Each	\$1,098	\$7,686	\$652	\$4,565	\$12,251
14	Dec. Teardrop	LED	PHILIPS DOMUS: 80W48LED4K-R-LE2F	26	Each	\$1,848	\$48,048	\$652	\$16,957	\$65,005
15	Shoe Box	LED	80W-4000K-TYPE II-Photocell	17	Each	\$830	\$14,110	\$652	\$11,087	\$25,197
16	Extra Stock	LED	3% Extra Steet Lighting Stock	3%	%	\$0	\$20,155.56	\$0	\$0	\$20,156
16	Performance and Payment Bonds			\$0	LS	\$0	\$20,000	\$0	\$0	\$20,000
SUBTOTALS:						Material Cost	\$692,008	Labor Cost	\$865,665	\$1,557,673
<b>TOTAL:</b>									<b>\$1,557,673</b>	



**TOTAL: \$1,557,673**



## ECM 2 – TRAFFIC SIGNAL LED RETROFIT

### INVESTIGATION

Wendel visited various intersections and reviewed inventory databases and billing sheets to investigate opportunities to upgrade the City of Beacon's traffic control system. Each intersection was evaluated based on energy efficiency potential and maintenance reduction potential. City personnel were interviewed regarding the existing condition and operation of the lighting systems.



The existing traffic lighting is comprised of approximately seventeen (17) intersection locations with a varying number of incandescent and Light Emitting Diode (LED) solid colored (red, green yellow) and arrow based signal lights. Wendel performed an analysis to estimate the potential energy savings that can be realized by replacing the existing incandescent based traffic signal lights with LED based signal lights.

LED based signal lighting designs offer longer life (typically 60,000+ hrs) and superior energy efficiencies when compared with the incandescent based signal designs. This scope will include a one to one replacement of the incandescent signal lights.

### EXISTING SYSTEM

The City of Beacon is billed for and maintains approximately 112 Signal Faces and associated control equipment at 17 intersections located throughout the City. The City's traffic control system operates 24 hours a day, 365 days a year. This equipment includes traffic heads pedestrian crosswalk heads, and controllers with a mix of both outdated incandescent technology as well as modern LED systems.

Using information gathered from the City, CHG&E utility bills, and the Service Classification No. 9 (SC-9) a baseline for the City traffic lighting energy usage costs was established. The monthly billing is primarily comprised of two components: (1) a usage rate that applies to energy ratings (45 kWh per face per month) and (2) a monthly tariff based on lighting design. Each location is billed according to the number of faces that exist at that location. A traffic signal "face" is defined by CHGE SC-9 and covers both 8 and 12 inch diameter incandescent as well as LED traffic signals.

Savings for the Traffic signals were determined as such:

Existing Utility Fees = Total Signal Faces Per Intersection X Current Fee per Signal Faces X 12 Months/Year

Proposed Utility Fees = Basic Service Charge (SC2 @ \$35/Month) X 12 Months/Year

Existing Energy Charges = Total Signal Faces Per Intersection X 45 Kwh/Month X 12 Months/Year X Average Utility Rate

Proposed Energy Charges = Proposed Equipment X Run Hours per Year

Savings = (Existing Utility Fees + Existing Energy Charges) – (Proposed Utility Fees + Proposed Energy Charges)

## PROPOSED SYSTEM

For the traffic lights under SC-9 to be able to benefit from the energy and cost savings of LED traffic signals and crossing signals, each intersection would have to have a meter installed. The lights would no longer fall under the SC-9, but would now fall under Service Classification No. 2 (SC-2). Please see Appendix A for applicable tariffs.

The following upgrades to the existing traffic control system are proposed:

- Retrofit all 8” or 12” red traffic signal incandescent lamps with equivalent red LED lamps.
- Retrofit all 8” or 12” yellow traffic signal incandescent lamps with equivalent yellow LED lamps.
- Retrofit all 8” or 12” green traffic signal incandescent lamps with equivalent green LED lamps.
- Remove existing incandescent cross walk and pedestrian signals and install new LED cross walk and pedestrian signals.
- Furnish and install new metered service for traffic signals at intersections that are currently not metered.

## RECOMMENDATIONS

Based on the findings of this analysis, Wendel recommends the implementation of this measure. Converting all existing incandescent traffic and pedestrian signals to LED will result in significant energy savings. Although the utility charge will be higher due to installing meters at each intersection it is expected that maintenance savings will be achieved through longer life LED lamps versus incandescent.

# City of Beacon

## LED Traffic Signals and Pedestrian Signals

Project No. 447103

Date. 2/3/16

ECM No. 2

City Wide

Measure Summary		
Energy Savings		
Total Demand Savings	23,031	kW/Year
Electrical Energy Savings	61,015	kWh/Year
Fossil Fuel Savings	-	mmBtu/Year
Cost Savings		
Electrical Dollar Savings	\$ 5,602	Per Year
Average Annual Maintenance Cost	\$ (253)	Per Year
Utility Charge Savings	\$ (1,598)	Per Year
Total Dollar Savings	\$4,256	Per Year
Direct Project Costs		
Material Cost	\$ 56,963	
Labor Cost	\$ 78,211	
<b>Total Measure Cost</b>	<b>\$93,095</b>	
Payback		
Simple Payback	21.9 Year(s)	

### Measure % Savings In System Energy Usage

#### Electricity

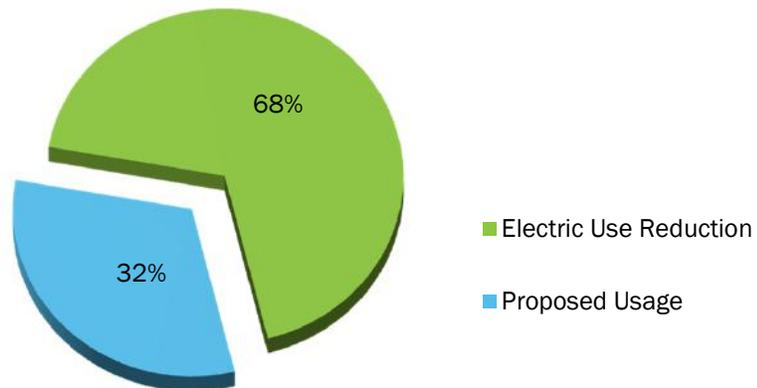



## Energy Rating in Watts

Project : City of Beacon  
 Project # : 447103  
 Measure : ECM - 2  
 Date : 02/03/16

Estimated by: SDM  
 Checked by: AMB  
 Approved by: DI

Cross Streets		Signal Faces Charged	Meter	Incandescent 8"			Incandescent 12"					LED 8"			LED 12"					Pedestrian			Controller						
				Red	Yellow	Green	Red	Yellow	Green	G ←	G/Y ←	Red	Yellow	Green	Red	Yellow	Green	G ←	G/Y ←	9"	12"	16x9"	Mech	Flash	179	Nema	2070		
Willow St.	& Verplanck Ave.	4		6	7	8	6	6	12	7	6	6	6	7	8	6	6	12	7	7	13	6	8	8	200	50	200	200	200
Blackburn	& Fishkill Ave.	3		6	7	8	6	6	12	7	6	6	6	7	8	6	6	12	7	7	13	6	8	8	200	50	200	200	200
East Main	& Main St.	4		6	7	8	6	6	12	7	6	6	6	7	8	6	6	12	7	7	13	6	8	8	200	50	200	200	200
Bank Square	&	4		6	7	8	6	6	12	7	6	6	6	7	8	6	6	12	7	7	13	6	8	8	200	50	200	200	200
Main St.	& Teller Ave.	4		6	7	8	6	6	12	7	6	6	6	7	8	6	6	12	7	7	13	6	8	8	200	50	200	200	200
Fishkill	& Verplanck Aves.	4		6	7	8	6	6	12	7	6	6	6	7	8	6	6	12	7	7	13	6	8	8	200	50	200	200	200
Wolcott	& Howland Aves.	2		6	7	8	6	6	12	7	6	6	6	7	8	6	6	12	7	7	13	6	8	8	200	50	200	200	200
North Ave.	& Verplanck Ave.	5		6	7	8	6	6	12	7	6	6	6	7	8	6	6	12	7	7	13	6	8	8	200	50	200	200	200
Fishkill Ave.	& Delavan Ave.	7		6	7	8	6	6	12	7	6	6	6	7	8	6	6	12	7	7	13	6	8	8	200	50	200	200	200
Fishkill Ave.	& Mill St.	5		6	7	8	6	6	12	7	6	6	6	7	8	6	6	12	7	7	13	6	8	8	200	50	200	200	200
South, Wolcott	& Dennis Aves.	12		6	7	8	6	6	12	7	6	6	6	7	8	6	6	12	7	7	13	6	8	8	200	50	200	200	200
Route 9D	& Verplanck Ave.	18		6	7	8	6	6	12	7	6	6	6	7	8	6	6	12	7	7	13	6	8	8	200	50	200	200	200
Route 9D	& Main St.	14		6	7	8	6	6	12	7	6	6	6	7	8	6	6	12	7	7	13	6	8	8	200	50	200	200	200
Wolcott Ave	& Tioranda	26		6	7	8	6	6	12	7	6	6	6	7	8	6	6	12	7	7	13	6	8	8	200	50	200	200	200
W. Church	& Beekman			6	7	8	6	6	12	7	6	6	6	7	8	6	6	12	7	7	13	6	8	8	200	50	200	200	200
N. Chestnut	& Main St.			6	7	8	6	6	12	7	6	6	6	7	8	6	6	12	7	7	13	6	8	8	200	50	200	200	200
Cedar	& Verplanck			6	7	8	6	6	12	7	6	6	6	7	8	6	6	12	7	7	13	6	8	8	200	50	200	200	200
Willow St.	& Verplanck			6	7	8	6	6	12	7	6	6	6	7	8	6	6	12	7	7	13	6	8	8	200	50	200	200	200
North Ave.	& Verplanck			6	7	8	6	6	12	7	6	6	6	7	8	6	6	12	7	7	13	6	8	8	200	50	200	200	200
Totals		112	0	114	133	152	114	228	133	114	114	133	152	114	228	133	133	247	114	152	152	3800	950	3800	3800	3800			





# MATERIAL & LABOR COST ESTIMATE

Project : City of Beacon  
 Project # : 447103  
 Measure : LED Traffic Signals and Pedestrian Signals -  
 Date : 02/03/16

Estimated by: Verde  
 Checked by: AMB  
 Approved by: DI  
 File: Cost Estimate

Item No.	Description	Qty.	Unit	Material		Labor		Total Cost Labor & Material
				Unit Price	Total	Unit Price	Total	
1	Remove Existing 8" Red Incandescent Traffic Signal and Install New 8" Red LED Traffic Signal	28	Each	\$68.00	\$1,904.00	\$208.62	\$5,841.23	\$7,745
2	Remove Existing 8" Yellow Incandescent Traffic Signal and Install New 8" Yellow LED Traffic Signal	40	Each	\$68.00	\$2,720.00	\$213.62	\$8,544.62	\$11,265
3	Remove Existing 8" Green Incandescent Traffic Light and Install New 8" Green LED Traffic Signal	28	Each	\$68.00	\$1,904.00	\$213.62	\$5,981.23	\$7,885
4	Remove Existing 12" Red Incandescent Traffic Signal and Install New 12" Red LED Traffic Signal	14	Each	\$68.00	\$952.00	\$213.62	\$2,990.62	\$3,943
5	Remove Existing 12" Yellow Incandescent Traffic Signal and Install New 12" Yellow LED Traffic Signal	40	Each	\$68.00	\$2,720.00	\$210.62	\$8,424.62	\$11,145
6	Remove Existing 12" Green Traffic Light and Install New 12" Green Traffic Signal LED Light	8	Each	\$68.00	\$544.00	\$210.62	\$1,684.92	\$2,229
7	Remove Existing 12" Yellow Incandescent Arrow and Install New 12" Yellow LED Arrow	4	Each	\$68.00	\$272.00	\$210.62	\$842.46	\$1,114
8	Remove Existing 12" Green Incandescent Arrow and Install New 12" Green LED Arrow	5	Each	\$68.00	\$340.00	\$213.62	\$1,068.08	\$1,408
9	Remove Existing (2) 12" Incandescent Pedestrian Signal Heads and Install (1) New 12" LED Bimodal Pedestrian Signal Head	15	Each	\$125.00	\$1,875.00	\$258.62	\$3,879.23	\$5,754
10	Install Central Hudson Metered Traffic Signal Service	13	Each	\$2,000.00	\$26,000.00	\$1,123.62	\$14,607.00	\$40,607
11								
12								
13								
14								
15								
16								
36								
37								
SUBTOTALS:				Materials:	\$39,231	Labor:	\$53,864	\$93,095



**TOTAL: \$93,095**



Location Name: City of Beacon Street Lighting  
 Address: Dutchess County  
 New York



Date: 8/11/2015  
 Utility Company: Central Hudson Gas & Electric  
 Acct. No.: 7411-1600-00-8

### ANNUAL ELECTRIC UTILITY DATA

Billing Year	Billing Month	Demand Total (kW)	Demand Cost	Usage Total (kWh)	Street Lighting Facilities Charge	Usage Supply Cost	Total Cost	Billing Days	Load Factor
2014	Jun	0.0	\$0	89,630	\$17,104	\$7,867	\$24,971	30	N/A
2014	Jul	0.0	\$0	89,630	\$17,104	\$7,867	\$24,971	31	N/A
2014	Aug	0.0	\$0	89,630	\$17,104	\$7,867	\$24,971	30	N/A
2014	Sep	0.0	\$0	89,630	\$17,104	\$7,867	\$24,971	31	N/A
2014	Oct	0.0	\$0	89,630	\$17,104	\$7,867	\$24,971	31	N/A
2014	Nov	0.0	\$0	89,630	\$17,104	\$7,867	\$24,971	30	N/A
2014	Dec	0.0	\$0	89,630	\$17,104	\$7,867	\$24,971	31	N/A
2015	Jan	0.0	\$0	89,630	\$17,104	\$7,867	\$24,971	31	N/A
2015	Feb	0.0	\$0	89,630	\$17,104	\$7,867	\$24,971	28	N/A
2015	Mar	0.0	\$0	89,630	\$17,104	\$7,867	\$24,971	31	N/A
2015	Apr	0.0	\$0	89,630	\$17,104	\$7,867	\$24,971	30	N/A
2015	May	0.0	\$0	89,630	\$17,104	\$7,867	\$24,971	31	N/A
<b>Avg./Totals:</b>		<b>0</b>	<b>\$0</b>	<b>1,075,560</b>	<b>\$205,252</b>	<b>\$94,402</b>	<b>\$299,654</b>	<b>365</b>	<b>N/A</b>

**Table Formulas:**

Hours per Month (h) = G x 24  
 Total Cost (F) = B + D + E  
 Load Factor (H) = C / (A x (h x 24))  
 Total Cost Includes Street Lighting Facility Charge  
 \*\$/kWh Does Not Include Street Lighting Facility Charge  
 Utility Information Derived From April 2015 Bill

**Summary**

Energy Intensity (kWh/sq.ft.):	N/A
Cost Intensity (\$/sq.ft.):	N/A
Blended Cost (inc. Facility Charge) / kWh:	\$0.279
<b>Avg. Cost / kW:</b>	<b>N/A</b>
<b>*Avg. Cost / kWh:</b>	<b>\$0.0878</b>

Electric Utility Data

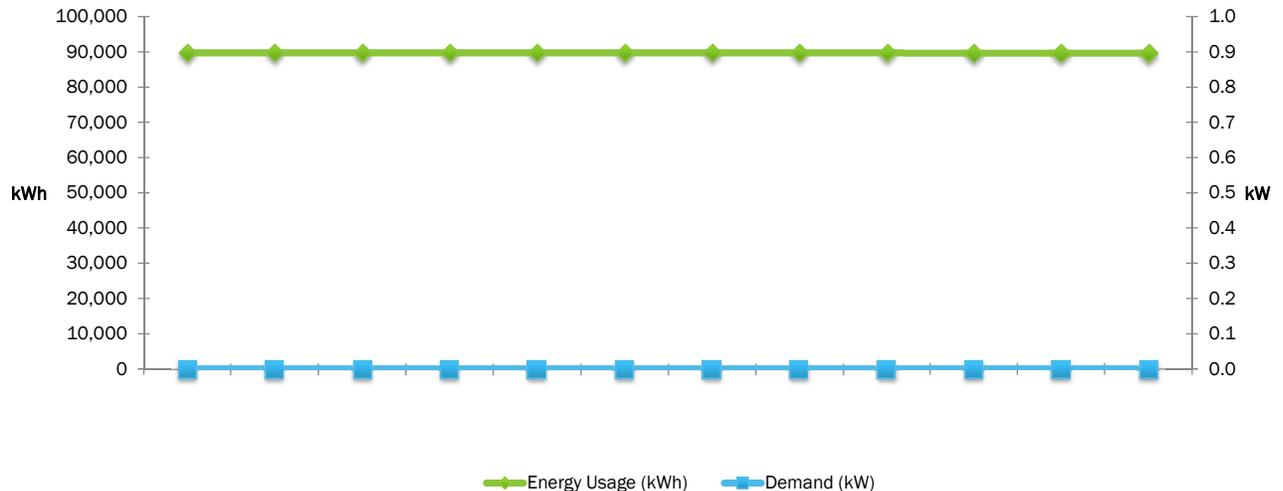

Location Name: City of Beacon Traffic Signals  
 Address: Dutchess County  
 New York



Date: 8/11/2015  
 Utility Company: Central Hudson Gas & Electric  
 Acct. No.: 7651-0800-00-6

**ANNUAL ELECTRIC UTILITY DATA**

	A	B	C	D	E	F	G	H	
Billing Year	Billing Month	Demand Total (kW)	Demand Cost	Usage Total (kWh)	Traffic Signal Charge	Usage Delivery Cost	Total Cost	Billing Days	Load Factor
2014	Jun	0.0	\$0	5,040	\$332	\$472	\$803	30	N/A
2014	Jul	0.0	\$0	5,040	\$332	\$472	\$803	31	N/A
2014	Aug	0.0	\$0	5,040	\$332	\$472	\$803	30	N/A
2014	Sep	0.0	\$0	5,040	\$332	\$472	\$803	31	N/A
2014	Oct	0.0	\$0	5,040	\$332	\$472	\$803	31	N/A
2014	Nov	0.0	\$0	5,040	\$332	\$472	\$803	30	N/A
2014	Dec	0.0	\$0	5,040	\$332	\$472	\$803	31	N/A
2015	Jan	0.0	\$0	5,040	\$332	\$472	\$803	31	N/A
2015	Feb	0.0	\$0	5,040	\$332	\$472	\$803	28	N/A
2015	Mar	0.0	\$0	5,040	\$332	\$472	\$803	31	N/A
2015	Apr	0.0	\$0	5,040	\$332	\$472	\$803	30	N/A
2015	May	0.0	\$0	5,040	\$332	\$472	\$803	31	N/A
<b>Avg./Totals:</b>		<b>0</b>	<b>\$0</b>	<b>60,480</b>	<b>\$3,978</b>	<b>\$5,661</b>	<b>\$9,639</b>	<b>365</b>	<b>N/A</b>

**Table Formulas:**

Hours per Month (h) = G x 24  
 Total Cost (F) = B + D + E  
 Load Factor (H) = C / (A x (h x 24))  
 \* Does Not Include Monthly 331.52\$ Traffic Signal Charge

**Summary**

Energy Intensity (kWh/sq.ft.):	N/A
Cost Intensity (\$/sq.ft.):	N/A
* Blended Cost (inc. Signal Charge) / kWh:	\$0.159
<b>Avg. Cost / kW:</b>	<b>N/A</b>
<b>* Avg. Cost / kWh:</b>	<b>\$0.0936</b>

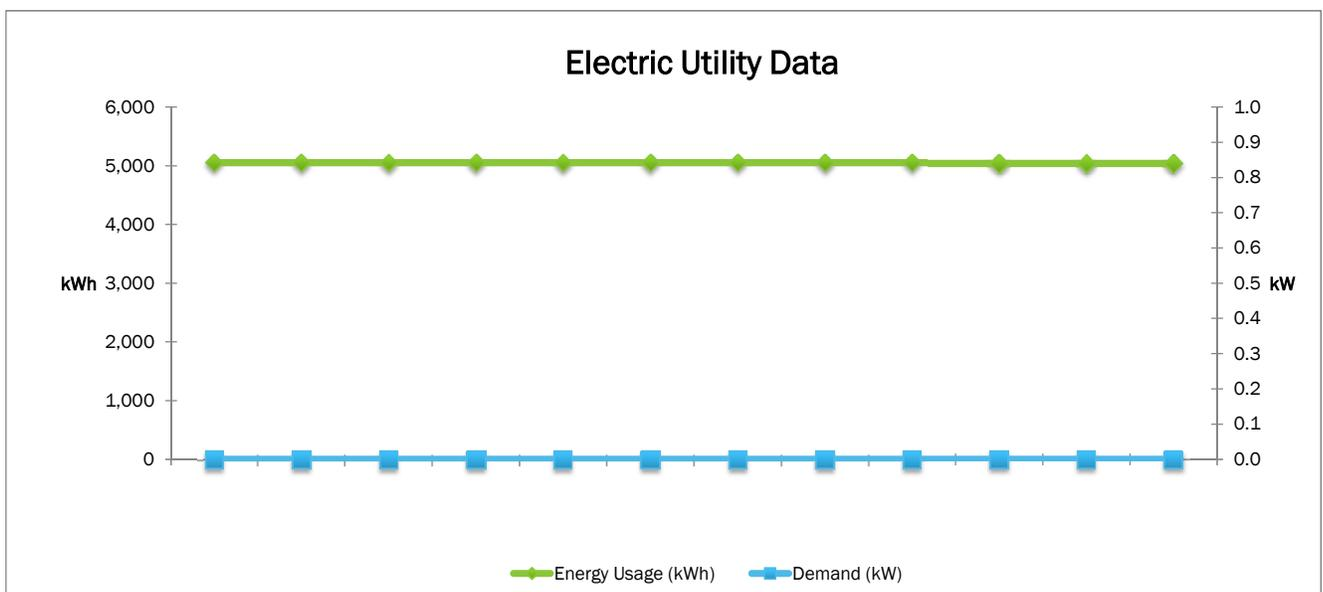

PSC NO: 15 ELECTRICITY LEAF: 215  
COMPANY: CENTRAL HUDSON GAS & ELECTRIC CORPORATION REVISION: 3  
INITIAL EFFECTIVE DATE: 06/25/04 SUPERSEDING REVISION: 2

SERVICE CLASSIFICATION NO. 8

PUBLIC STREET AND HIGHWAY LIGHTING

APPLICABLE TO USE OF SERVICE FOR

Sales and delivery of electric power supply by the Company or delivery of electric power supply provided by a Retail Supplier to customers for use in the lighting of streets, highways, roadways and ways open to public use for the State of New York, counties, townships, cities and incorporated villages.

CHARACTER OF SERVICE

Photo-controlled lighting from dusk to dawn supplied from secondary voltages as designated by the Company for a total of approximately 4,000 hours per year.

The Company shall own, operate and maintain all facilities used to supply service hereunder unless the customer elects to own and maintain their own fixtures.

The Company shall furnish, operate, maintain, repair and when necessary replace all luminaire equipment, including all lamps and photocells used in furnishing lighting from Company owned fixtures.

For customer owned fixtures which are selected and purchased in accordance with standards for Company owned fixtures, the Company shall maintain, repair and when necessary replace all lamps and photocells. Maintenance for non-standard customer owned fixtures shall be limited to lamps and photocells, provided the lamps and/or photocells correspond to standard Company maintained materials. The customer shall be responsible for maintaining special or ornamental customer poles used to support customer owned luminaires.

LINE EXTENSIONS

If an extension is required from an existing underground or overhead circuit to provide street lighting, the customer will pay the Company for the costs incurred or install at their cost all footage in excess of 100 feet of wire for overhead circuits and 25 feet of wire for underground circuits. The customer shall be responsible for the trench and conduit. The Company will own and maintain all such circuits.

FIBERGLASS POLE INSTALLATION

If a fiberglass pole installation is required, the customer shall provide a concrete base or acceptable foundation.



PSC NO: 15 ELECTRICITY LEAF: 216  
COMPANY: CENTRAL HUDSON GAS & ELECTRIC CORPORATION REVISION: 6  
INITIAL EFFECTIVE DATE: 06/25/04 SUPERSEDING REVISION: 5

SERVICE CLASSIFICATION NO. 8 (Cont'd)

PUBLIC STREET AND HIGHWAY LIGHTING (Cont'd)

APPLICATION FOR SERVICE

The Company shall require a written application (Street Light Authority Order) for additional service, which will include a list of the quantity and size of luminaires to be supplied. Such application when accepted by the Company, shall constitute an agreement between customer and Company, subject to the terms and conditions set forth in this Service Classification.

TERM

The initial term of service for each luminaire shall be five years, unless otherwise approved by the Company. Service shall continue in effect thereafter until canceled by either party upon ninety days written notice.

DETERMINATION OF BILLING QUANTITIES

The charge for lighting service hereunder during each calendar month shall be based upon the number of luminaires in service as of the first day of that calendar month.

TERMS OF PAYMENT

Bills are due when personally served or three (3) days after mailing. Bills shall be subject to a late payment charge, in accordance with General Information, Section 16, if payment is not made by the date specified on the bill which shall be not less than twenty (20) days from the due date.

RATES

- A. Company Owned and Maintained - The Company will own and maintain fixtures, brackets, photocells and lamps and replace all associated hardware when necessary and reasonable. The Company will maintain supporting equipment provided pursuant to Rate D of this Service Classification. The customer shall pay the Company an annual charge based on the size and type of light in service. Sales and delivery of electric power supply by the Company or delivery of electric power supply provided by a Retail Supplier will be based on the size and type of light in service.

PSC NO: 15 ELECTRICITY  
 COMPANY: CENTRAL HUDSON GAS & ELECTRIC CORPORATION  
 INITIAL EFFECTIVE DATE: 07/01/10  
 Issued in Compliance with Order in C.09-E-0588 dated June 18, 2010

LEAF: 217  
 REVISION: 11  
 SUPERSEDING REVISION: 9

**SERVICE CLASSIFICATION NO. 8** (Cont'd)

**PUBLIC STREET AND HIGHWAY LIGHTING** (Cont'd)

RATES (Cont'd)

A. Company Owned and Maintained (Cont'd)

1) Standard Lights

a. Annual Service

<u>Lamp Watts</u>	<u>Lamp Lumens</u>	<u>Lamp Type</u>	<u>Fixture Wattage</u>	<u>Annual kWh</u>	<u>Annual Charge Effective</u>		
					<u>July 1, 2010</u>	<u>July 1, 2011</u>	<u>July 1, 2012</u>
70	5,800	Sodium Vapor	86	344	\$139.58	\$144.44	\$149.24
150	16,000	Sodium Vapor	180	720	155.14	160.54	165.87
250	27,000	Sodium Vapor	316	1,264	188.09	194.64	201.10
400	50,000	Sodium Vapor	496	1,984	212.12	219.50	226.79
1000	140,000	Sodium Vapor	1,164	4,656	351.27	363.49	375.56
250	20,500	Metal Halide	300	1,200	213.99	221.44	228.79
400	36,000	Metal Halide	464	1,856	207.67	214.90	222.03

2) Non-Standard Lights

The following charges apply to existing lights only. These lights are no longer replaced in kind or installed at new locations.

a. Annual Service

<u>Lamp Watts</u>	<u>Lamp Lumens</u>	<u>Lamp Type</u>	<u>Fixture Wattage</u>	<u>Annual kWh</u>	<u>Annual Charge Effective</u>		
					<u>July 1, 2010</u>	<u>July 1, 2011</u>	<u>July 1, 2012</u>
92	1,000	Incandescent	92	368	\$112.68	\$116.60	\$120.47
189	2,500	Incandescent	189	756	149.04	154.23	159.35
295	4,000	Incandescent	295	1,180	178.83	185.05	191.19
405	6,000	Incandescent	405	1,620	204.85	211.98	219.02
100	3,600	Mercury Vapor	126	504	143.38	148.37	153.30
175	7,000	Mercury Vapor	208	832	155.29	160.69	166.02
250	11,000	Mercury Vapor	296	1,184	168.44	174.30	180.09
400	15,000	Mercury Vapor	455	1,820	196.53	203.37	210.12
400	20,000	Mercury Vapor	455	1,820	196.53	203.37	210.12
1000	60,000	Mercury Vapor	1,080	4,320	288.33	298.36	308.27

PSC NO: 15 ELECTRICITY  
 COMPANY: CENTRAL HUDSON GAS & ELECTRIC CORPORATION  
 INITIAL EFFECTIVE DATE: 07/01/10  
 Issued in Compliance with Order in C.09-E-0588 dated June 18, 2010

LEAF: 218  
 REVISION: 12  
 SUPERSEDING REVISION: 10

**SERVICE CLASSIFICATION NO. 8** (Cont'd)

**PUBLIC STREET AND HIGHWAY LIGHTING** (Cont'd)

RATES (Cont'd)

A. Company Owned and Maintained (Cont'd)

3) Lamp, Fixture and Pole Package

This package includes lamp, fixture, photocell, fiberglass pole and necessary mounting hardware.

a. Annual Service

Lamp Watts	Lamp Lumens	Lamp Type	Fixture Wattage	Fixture	Annual kWh	Annual Charge Effective		
						July 1, 2010	July 1, 2011	July 1, 2012
70	5,800	Sodium Vapor	86	Colonial Post Top	344	\$302.10	\$312.61	\$322.99
70	5,800	Sodium Vapor	86	Cobrahead	344	380.83	394.08	407.16
150	16,000	Sodium Vapor	180	Cobrahead	720	394.74	408.48	422.04
175	14,000	Metal Halide	205	Cutoff Rectangular	820	435.09	450.23	465.18
250	20,500	Metal Halide	300	Cutoff Rectangular	1,200	449.66	465.31	480.76
400	36,000	Metal Halide	464	Cutoff Rectangular	1,856	476.16	492.73	509.09

PSC NO: 15 ELECTRICITY  
 COMPANY: CENTRAL HUDSON GAS & ELECTRIC CORPORATION  
 INITIAL EFFECTIVE DATE: 07/01/10  
 Issued in Compliance with Order in C.09-E-0588 dated June 18, 2010

LEAF: 218.1  
 REVISION: 9  
 SUPERSEDING REVISION: 7

**SERVICE CLASSIFICATION NO. 8** (Cont'd)

**PUBLIC STREET AND HIGHWAY LIGHTING** (Cont'd)

RATES (Cont'd)

A. Company Owned and Maintained (Cont'd)

4) Standard Decorative and Special Purpose Luminaires

a. Annual Service

Lamp Watts	Lamp Lumens	Lamp Type	Fixture Wattage	Fixture	Annual kWh	Annual Charge Effective		
						July 1, 2010	July 1, 2011	July 1, 2012
70	5,800	Sodium Vapor	86	Acorn Dec.	344	\$176.59	\$182.74	\$188.81
85	6,000	Induction	85	Acorn Dec.	340	239.53	247.87	256.10
175	14,000	Metal Halide	205	Acorn Dec.	820	223.50	231.28	238.96
150	16,000	Sodium Vapor	180	Victorian Gaslight	720	227.55	235.47	243.29
250	27,000	Sodium Vapor	316	Highway Setback	1,264	215.92	223.43	230.85
400	50,000	Sodium Vapor	496	Highway Setback	1,984	242.76	251.21	259.55
250	20,500	Metal Halide	300	Highway Setback	1,200	247.39	256.00	264.50
400	36,000	Metal Halide	464	Highway Setback	1,856	240.91	249.29	257.57
400	50,000	Sodium Vapor	496	Flood- light	1,984	224.67	232.49	240.21
400	36,000	Metal Halide	464	Flood- light	1,856	215.34	222.83	230.23
1000	110,000	Metal Halide	1,100	Flood- light	4,400	369.91	382.78	395.49
250	27,000	Sodium Vapor	316	Dec. Teardrop	1,264	260.13	269.18	278.12
400	50,000	Sodium Vapor	496	Dec. Teardrop	2,480	305.14	315.76	326.24
250	20,500	Metal Halide	300	Dec. Teardrop	1,200	281.87	291.68	301.36
400	36,000	Metal Halide	464	Dec. Teardrop	1,856	288.94	299.00	308.93

PSC NO: 15 ELECTRICITY  
 COMPANY: CENTRAL HUDSON GAS & ELECTRIC CORPORATION  
 INITIAL EFFECTIVE DATE: 07/01/10  
 Issued in Compliance with Order in C.09-E-0588 dated June 18, 2010

LEAF: 218.2  
 REVISION: 6  
 SUPERSEDING REVISION: 4

**SERVICE CLASSIFICATION NO. 8** (Cont'd)

**PUBLIC STREET AND HIGHWAY LIGHTING** (Cont'd)

**RATES** (Cont'd)

- B. Customer Owned/Company Maintained - The Company will maintain and/or replace photocells and lamps used in furnishing lighting from Company approved customer owned equipment. Maintenance of non-standard customer owned fixtures shall be limited to lamps and photocells, provided lamps and/or photocells correspond to Company standards. This does not apply to fixtures and poles. The customer shall pay the Company an annual charge based on the size and type of light in service. Sales and delivery of electric power supply by the Company or delivery of electric power supply provided by a Retail Supplier will be based on the size and type of light in service.

1) Standard Lights

a. Annual Service

<u>Lamp Watts</u>	<u>Lamp Lumens</u>	<u>Lamp Type</u>	<u>Fixture Wattage</u>	<u>Annual kWh</u>	<u>Annual Charge Effective</u>		
					<u>July 1, 2010</u>	<u>July 1, 2011</u>	<u>July 1, 2012</u>
85	6,000	Induction	85	340	\$41.59	\$43.04	\$44.47
70	5,800	Sodium Vapor	86	344	47.43	49.08	50.71
150	16,000	Sodium Vapor	180	720	61.00	63.12	65.22
250	27,000	Sodium Vapor	316	1,264	80.63	83.44	86.21
400	50,000	Sodium Vapor	496	1,984	106.98	110.70	114.38
1000	140,000	Sodium Vapor	1,164	4,656	209.33	216.61	223.80
175	14,000	Metal Halide	205	820	69.11	71.52	73.89
250	20,500	Metal Halide	300	1,200	83.52	86.43	89.30
400	36,000	Metal Halide	464	1,856	104.79	108.44	112.04
1000	108,000	Metal Halide	1,065	4,400	222.96	230.72	238.38

PSC NO: 15 ELECTRICITY  
 COMPANY: CENTRAL HUDSON GAS & ELECTRIC CORPORATION  
 INITIAL EFFECTIVE DATE: 07/01/10  
 Issued in Compliance with Order in C.09-E-0588 dated June 18, 2010

LEAF: 219  
 REVISION: 10  
 SUPERSEDING REVISION: 8

**SERVICE CLASSIFICATION NO. 8** (Cont'd)

**PUBLIC STREET AND HIGHWAY LIGHTING** (Cont'd)

RATES (Cont'd)

B. Customer Owned/Company Maintained (Cont'd)

2) Non-Standard Lights

The following charges apply to existing lights only. These lights are no longer replaced in kind or installed at new locations.

a. Annual Service

<u>Lamp Watts</u>	<u>Lamp Lumens</u>	<u>Lamp Type</u>	<u>Fixture Wattage</u>	<u>Annual kWh</u>	<u>Annual Charge Effective</u>		
					<u>July 1, 2010</u>	<u>July 1, 2011</u>	<u>July 1, 2012</u>
100	9,500	Sodium Vapor	146	584	\$56.09	\$58.04	\$59.97
92	1,000	Incandescent	92	368	69.61	72.03	74.42
189	2,500	Incandescent	189	756	92.27	95.48	98.65
295	4,000	Incandescent	295	1,180	108.45	112.22	115.95
405	6,000	Incandescent	405	1,620	140.80	145.70	150.54
620	10,000	Incandescent	620	2,480	171.85	177.83	183.73
175	7,000	Vapor Mercury	208	832	64.34	66.58	68.79
250	11,000	Vapor Mercury	296	1,184	77.41	80.10	82.76
400	15,000	Vapor Mercury	455	1,820	103.84	107.45	111.02
400	20,000	Vapor Mercury	455	1,820	103.84	107.45	111.02
1000	60,000	Vapor Mercury	1,080	4,320	195.12	201.91	208.61

PSC NO: 15 ELECTRICITY  
 COMPANY: CENTRAL HUDSON GAS & ELECTRIC CORPORATION  
 INITIAL EFFECTIVE DATE: 07/01/10  
 Issued in Compliance with Order in C.09-E-0588 dated June 18, 2010

LEAF: 220  
 REVISION: 12  
 SUPERSEDING REVISION: 10

**SERVICE CLASSIFICATION NO. 8** (Cont'd)

**PUBLIC STREET AND HIGHWAY LIGHTING** (Cont'd)

RATES (Cont'd)

3) Other Charges

- a) Pre-attachment survey fee is \$7.65 per attachment effective July 1, 2010, \$7.92 effective July 1, 2011 and \$8.18 effective July 1, 2012.
- b) Annual pole rental charge is \$5.97 for a Company sole owned pole effective July 1, 2010, \$6.18 effective July 1, 2011 and \$6.39 effective July 1, 2012 or \$2.99 for a joint owned pole effective July 1, 2010, \$3.09 effective July 1, 2011 and \$3.19 effective July 1, 2012.
- c) Payment of any costs associated with make ready work, which is necessary for rearrangement of Company facilities.

- C. Customer Owned and Maintained - The customer may desire to own and maintain, the fixture, photocell, bracket, lamp, and use a Company or customer owned pole to support it. The customer must enter into an Attachment Agreement for the purpose of establishing responsibility and liability associated with attaching to Company poles. Sales and delivery of electric power supply by the Company or delivery of electric power supply provided by a Retail Supplier will be based on the size and type of light in service.

1) Standard Lights

a. Annual Service

<u>Lamp Watts</u>	<u>Lamp Lumens</u>	<u>Lamp Type</u>	<u>Fixture Wattage</u>	<u>Annual kWh</u>	<u>Annual Charge Effective</u>		
					<u>July 1, 2010</u>	<u>July 1, 2011</u>	<u>July 1, 2012</u>
70	5,800	Sodium Vapor	86	344	\$21.08	\$21.81	\$22.53
100	9,500	Sodium Vapor	146	584	29.75	30.79	31.81
150	16,000	Sodium Vapor	180	720	34.65	35.86	37.05
250	27,000	Sodium Vapor	316	1,264	54.30	56.19	58.06
400	50,000	Sodium Vapor	496	1,984	80.28	83.07	85.83
1000	140,000	Sodium Vapor	1,164	4,656	176.76	182.91	188.98
100	8,500	Metal Halide	130	520	27.44	28.39	29.33
175	14,000	Metal Halide	205	820	38.28	39.61	40.93
250	20,500	Metal Halide	300	1,200	51.99	53.80	55.59
400	36,000	Metal Halide	464	1,856	75.66	78.29	80.89
1000	110,000	Metal Halide	1,100	4,400	167.52	173.35	179.11

PSC NO: 15 ELECTRICITY  
 COMPANY: CENTRAL HUDSON GAS & ELECTRIC CORPORATION  
 INITIAL EFFECTIVE DATE: 12/01/10

LEAF: 221  
 REVISION: 10  
 SUPERSEDING REVISION: 9

**SERVICE CLASSIFICATION NO. 8** (Cont'd)

**PUBLIC STREET AND HIGHWAY LIGHTING** (Cont'd)

RATES (Cont'd)

C. Customer Owned and Maintained (Cont'd)

2) Non-Standard Lights

a. Annual Service

Lamp Watts	Lamp Lumens	Lamp Type	Fixture Wattage	Annual kWh	Annual Charge Effective		
					July 1, 2010	July 1, 2011	July 1, 2012
92	1,000	Incandescent	92	368	\$21.95	\$22.71	\$23.46
189	2,500	Incandescent	189	756	35.96	37.21	38.45
405	6,000	Incandescent	405	1,620	67.15	69.49	71.80
175	7,000	Mercury Vapor	208	832	38.70	40.05	41.38
250	11,000	Mercury Vapor	296	1,184	51.41	53.20	54.97
400	20,000	Mercury Vapor	455	1,820	74.37	76.96	79.52

The annual kWh and annual charges for Light Emitting Diode (LED) fixtures applicable under this Schedule will be shown on a statement filed with the Public Service Commission apart from this Schedule. Not less than fifteen days prior to any changes in LED fixture options a revised statement, including the changes, will be filed with the Public Service Commission.

3) In cases where the wattage is not listed in 1) or 2) above, the annual charge will be based on usage determined in the following manner:

Annual kWh = (Fixture Wattage ÷ 1,000) X 4,000 Burning Hours Per Year



PSC NO: 15 ELECTRICITY  
COMPANY: CENTRAL HUDSON GAS & ELECTRIC CORPORATION  
INITIAL EFFECTIVE DATE: 07/01/10  
Issued in Compliance with Order in C.09-E-0588 dated June 18, 2010

LEAF: 222  
REVISION: 11  
SUPERSEDING REVISION: 9

**SERVICE CLASSIFICATION NO. 8** (Cont'd)

**PUBLIC STREET AND HIGHWAY LIGHTING** (Cont'd)

RATES (Cont'd)

C. Customer Owned and Maintained (Cont'd)

3) Other Charges

- a) Pre-attachment survey fee is \$7.65 effective July 1, 2010, \$7.92 effective July 1, 2011 and \$8.18 effective July 1, 2012 per attachment.
- b) Annual pole rental charge is \$5.97 effective July 1, 2010, \$6.18 effective July 1, 2011 and \$6.39 effective July 1, 2012 for a Company sole owned pole or \$2.99 effective July 1, 2010, \$3.09 effective July 1, 2011 and \$3.19 effective July 1, 2012 for a joint owned pole.
- c) Payment of any costs associated with make ready work, which is necessary for rearrangement of Company facilities.

D. Rates for Supporting Equipment

- 1) Annual charge for standard Company poles used solely for street lighting is \$52.21 effective July 1, 2010, \$54.03 effective July 1, 2011 and \$55.82 effective July 1, 2012.
- 2) Annual charge for mastarms greater than 14 feet is \$29.48 effective July 1, 2010, \$30.51 effective July 1, 2011 and \$31.52 effective July 1, 2012.
- 3) Annual charge for a fluted decorative fiberglass pole used solely for street lighting is \$272.68 effective July 1, 2010, \$282.17 effective July 1, 2011 and \$291.54 effective July 1, 2012.
- 4) Annual charge for a fiberglass pole up to 20' for Decorative Lighting other than Highway Setback is \$241.68 effective July 1, 2010, \$250.09 effective July 1, 2011, and \$258.39 effective July 1, 2012.
- 5) Annual charge for a fiberglass pole for Highway Setback Lighting with 30' mounting height is \$241.68 effective July 1, 2010, \$250.09 effective July 1, 2011, and \$258.39 effective July 1, 2012.
- 6) Annual charge for a decorative arm for Decorative Teardrop Lighting is \$116.06 effective July 1, 2010, \$120.10 effective July 1, 2011 and \$124.09 effective July 1, 2012.

PSC NO: 15 ELECTRICITY LEAF: 222.1  
COMPANY: CENTRAL HUDSON GAS & ELECTRIC CORPORATION REVISION: 7  
INITIAL EFFECTIVE DATE: 07/01/09 SUPERSEDING REVISION: 6  
Issued in Compliance with Order in C.08-E-0887 dated June 22, 2009

**SERVICE CLASSIFICATION NO. 8** (Cont'd)

**PUBLIC STREET AND HIGHWAY LIGHTING** (Cont'd)

**SYSTEM BENEFITS CHARGE, RENEWABLE PORTFOLIO STANDARD CHARGE, ENERGY COST ADJUSTMENT MECHANISM, ELECTRIC BILL CREDIT, MERCHANT FUNCTION CHARGE, AND NEW YORK STATE ASSESSMENT**

System Benefits Charge

The System Benefits Charge (SBC), as described in General Information Section 36.A, shall apply to all electricity delivered under this Service Classification. Said charges will be applied each month to the kilowatthours determined in the manner set forth hereunder.

Renewable Portfolio Standard Charge

The Renewable Portfolio Standard Charge, as described in General Information Section 36.C, shall apply to all electricity delivered under this Service Classification. Said charges will be applied each month to the kilowatthours determined in the manner set forth hereunder.

Purchased Power Adjustment and Miscellaneous Charges

The provisions of the Company's Purchased Power Adjustment and Miscellaneous Charges, as described in General Information Section 29, shall apply to all electricity delivered under this Service Classification. Said charges will be applied each month to the kilowatthours determined in the manner set forth hereunder.

Electric Bill Credit

The Electric Bill Credit, as described in General Information Section 36.B, shall apply to all customers served under this Service Classification.

Market Price Charge and Market Price Adjustment

The provisions of the Company's Market Price Charge and Market Price Adjustment, as described in General Information Section 29, shall apply to the electricity provided and sold by the Company under this Service Classification. Said charges will be applied each month to the kilowatthours determined in the manner set forth hereunder. Customers participating in the Retail Access Program as described in General Information Section 35 shall not be subject to these charges.

PSC NO: 15 ELECTRICITY  
 COMPANY: CENTRAL HUDSON GAS & ELECTRIC CORPORATION  
 INITIAL EFFECTIVE DATE: 07/31/09  
 Issued in Compliance with Order in C.08-E-0887 dated June 22, 2009

LEAF: 222.2  
 REVISION: 7  
 SUPERSEDING REVISION: 6

**SERVICE CLASSIFICATION NO. 8** (Cont'd)

**PUBLIC STREET AND HIGHWAY LIGHTING** (Cont'd)

SYSTEM BENEFITS CHARGE, RENEWABLE PORTFOLIO STANDARD CHARGE, ENERGY COST ADJUSTMENT MECHANISM, ELECTRIC BILL CREDIT, MERCHANT FUNCTION CHARGE, AND NEW YORK STATE ASSESSMENT (Cont'd)

MERCHANT FUNCTION CHARGE

The Merchant Function Charge, as described in General Information Section 36.E, shall apply to all electricity delivered under this Service Classification. For billing purposes, the Merchant Function Charge will be included in the Miscellaneous Charges.

NEW YORK STATE ASSESSMENT

The New York State Assessment, as described in General Information Section 36.F, shall apply to all electricity delivered under this Service Classification.

For billing purposes, the Electric Bill Credit will be included in the Miscellaneous Charges. The System Benefits Charge, Renewable Portfolio Standard Charge, Electric Bill Credit, and applicable portions of the Energy Cost Adjustment Mechanism, Merchant Function Charge, and New York State Assessment will apply to the kWh determined in the following manner:

$$\text{kWh} = (\text{Total Wattage} \div 1,000) \times (\text{Monthly Burning Hours}^*)$$

BURNING HOURS\*

January	420	July	260
February	350 (360 During Leap Year)	August	290
March	340	September	320
April	300	October	370
May	270	November	400
June	240	December	440

INCREASE IN RATES AND CHARGES

The rates and charges under this Service Classification including the System Benefits Charge, Renewable Portfolio Standard Charge, Electric Bill Credit, the applicable portions of the Energy Cost Adjustment Mechanism, Merchant Function Charge, and New York State Assessment, are increased pursuant to General Information Section 30, to reflect tax rates applicable within the municipality where the customer takes service.

..DID: 17604  
..TXT: PSC NO: 15 ELECTRICITY LEAF: 223  
COMPANY: CENTRAL HUDSON GAS & ELECTRIC CORPORATION REVISION: 2  
INITIAL EFFECTIVE DATE: 11/01/01 SUPERSEDING REVISION: 1  
STAMPS: Issued in Compliance with Order in C.00-E-1273 dated October 25, 2001  
RECEIVED: 10/31/01 STATUS: Effective EFFECTIVE: 11/01/01

SERVICE CLASSIFICATION NO. 8 (Cont'd)

PUBLIC STREET AND HIGHWAY LIGHTING (Cont'd)

SPECIAL PROVISIONS

The numbering of the paragraphs hereunder begins with the above service classification number.

- 8.1 No more than 5% of the Company Owned lights in any municipality shall be replaced in any year unless otherwise approved by the Company in writing.
- 8.2 The Company, at the customer's request, will change the type or size of lights at existing locations, install lights at new locations and remove existing lights provided that the design of all new lights and supports must be approved by the Company.
- 8.3 The Company shall have the right to remove any Company owned equipment, or to discontinue service to customer owned equipment, which in the opinion of the Company shall have become unsatisfactory for further service by reason of deterioration, civil commotion, state of war, explosion, fire, storm, flood, lightning or any other cause reasonably beyond the Company's control. Replacement shall be limited to equipment considered appropriate by the Company at the date of re-installation.
- 8.4 The Company shall not be obligated to repair or replace in kind any non-standard luminaire. The Company will remove the non-standard luminaire or, at the customer's request, replace it with any standard luminaire offered for service at that time for which the customer will be charged the appropriate rates.
- 8.5 As a condition of receiving service hereunder, the customer authorizes the Company, insofar as it lawfully may, to trim, cut, remove and to keep trimmed, cut and remove any trees and all other obstructions which, in the opinion of the Company, interfere with or may tend to interfere with the construction, operation and maintenance of the Company's service provided hereunder. Tree trimming required for light distribution on the highway, street and/or sidewalk surfaces is the responsibility of the customer, and shall be done by the customer or at the customer's expense.

Issued by: Arthur R. Upright, Senior Vice President, Poughkeepsie, New York

PSC NO: 15 ELECTRICITY  
COMPANY: CENTRAL HUDSON GAS & ELECTRIC CORPORATION  
INITIAL EFFECTIVE DATE: 06/25/04

LEAF: 224  
REVISION: 1  
SUPERSEDING REVISION: 0

SERVICE CLASSIFICATION NO. 8 (Cont'd)

PUBLIC STREET AND HIGHWAY LIGHTING (Cont'd)

SPECIAL PROVISION (Cont'd)

8.6 Upon termination of service hereunder the Company shall have the right within a reasonable time thereafter to remove all facilities placed, installed or used by it to provide the service hereunder.

Upon making such removal, the Company shall leave the public streets and places affected thereby in the same or as good condition as they were immediately prior thereto.

8.7 When in the judgement of the Company an existing facility requires abnormal expenditures because of damage through vandalism or otherwise, service to the location may be terminated and the facility removed, or the Company may require that special provisions be made for the protection and maintenance of the facilities.

8.8 Customers taking service under Rate B or C of this Service Classification are required to notify the Company in writing of any changes made to equipment within thirty (30) days of any such changes.

LIABILITY

The failure of the Company to furnish any part of the service to be provided under this Service Classification shall not be construed as a breach of contract or render the Company liable for damages to the customer if such failure is caused by reason of accidents, strikes, state or municipal interference, action of the elements or other causes beyond the reasonable control of the Company, by absence of a report to the Company of lamps not burning or by the inability of the Company to obtain, without legal proceedings, the necessary consent for the erection of the poles, wires and other equipment required to furnish the service herein contemplated.

No person, not a party to this contract, shall have any claim against either party hereto for any loss or damage arising out of the performance or nonperformance of the work or services provided for in this agreement, whether such loss or damage be the result of negligence or any other cause.

The customer shall indemnify and save harmless the Company from and against all liability for damages or injuries to persons or property arising from the installation or maintenance of any customer owned equipment or any act of the customer, its agents, servants or employees.

Issued by: Arthur R. Upright, Senior Vice President, Poughkeepsie, New York

..DID: 17605  
..TXT: PSC NO: 15 ELECTRICITY LEAF: 225  
COMPANY: CENTRAL HUDSON GAS & ELECTRIC CORPORATION REVISION: 2  
INITIAL EFFECTIVE DATE: 11/01/01 SUPERSEDING REVISION: 0  
STAMPS: Issued in Compliance with Order in C.00-E-1273 dated October 25, 2001  
RECEIVED: 10/31/01 STATUS: Effective EFFECTIVE: 11/01/01

SERVICE CLASSIFICATION NO. 9

TRAFFIC SIGNAL SERVICE

APPLICABLE TO USE OF SERVICE FOR

This Service Classification is closed to new customers as of November 1, 2001. New customers requiring traffic signal service on and after November 1, 2001 will be required to take metered service under Service Classification No. 2.

Traffic signals, caution signals and operating control equipment owned, installed and maintained by the State of New York, counties, townships, cities and incorporated villages for which the State of New York has issued the appropriate permits, and where the Company has facilities appropriate to the unmetered service.

CHARACTER OF SERVICE

Continuous, 60 cycle, single phase alternating current delivered at 120, 120/208 or 120/240 volts, voltage depending on availability and the customer requirements.

APPLICATION FOR SERVICE

The Company shall require a written application for additional service, which will include the wattage of lamps and associated computation of signal-faces.

TERM

The initial term of service for each signal shall be five years, unless otherwise approved by the Company. Service shall continue in effect thereafter until canceled by either party upon ninety days written notice.

DETERMINATION OF BILLING QUANTITIES

- A. The Company shall estimate the monthly use of the facility serviced hereunder based on the electrical ratings of all equipment installed and the anticipated monthly burning hours. The monthly charge shall be based on this estimate as of the first day of the calendar month. The customer will notify the Company prior to making any changes to an existing installation.
- B. A signal-face of a stop and go signal is defined as a signal or portion of a signal designed to control traffic approaching from a single direction. Each signal-face consists of two or more lenses of which only one is illuminated at any one time with lamps installed having a capacity not exceeding 69 watts per lens, and a control mechanism other than the electromagnetic type.
- C. Lamps simultaneously illuminating a second lens on the face of a stop and go signal will be considered one signal-face.

Issued by: Arthur R. Upright, Senior Vice President, Poughkeepsie, New York

PSC NO: 15 ELECTRICITY  
 COMPANY: CENTRAL HUDSON GAS & ELECTRIC CORPORATION  
 INITIAL EFFECTIVE DATE: 04/01/11

LEAF: 226  
 REVISION: 12  
 SUPERSEDING REVISION: 11

**SERVICE CLASSIFICATION NO. 9** (Cont'd)

**TRAFFIC SIGNAL SERVICE** (Cont'd)

**DETERMINATION OF BILLING QUANTITIES** (Cont'd)

- D. Lamps illuminating fixed or flashing caution lights will be considered one signal-face.
- E. Control mechanisms of the electromagnetic type in excess of 25 watts will be considered one signal-face.
- F. Lamps exceeding 69 watts/lens will be considered one signal-face for the first 69 watts and one additional signal-face for each major fraction thereof.
- G. Walk/Don't Walk pedestrian controls using two lamps will be considered at least one and one-half signal-faces, unless each lamp is larger than 69 watts. If each lamp is larger than 69 watts, the Company will compute the number of signal-faces to be billed.

**MONTHLY RATE**

The price per signal-face of light (as defined above) for electricity supplied is as follows:

	Monthly Charge Effective		
	<u>July 1, 2010</u>	<u>July 1, 2011</u>	<u>July 1, 2012</u>
Monthly Rate per Signal-Face	\$2.76	\$2.86	\$2.96

**ELECTRIC BILL CREDIT SYSTEM BENEFITS CHARGE, RENEWABLE PORTFOLIO STANDARD CHARGE, ENERGY COST ADJUSTMENT MECHANISM, MERCHANT FUNCTION CHARGE, AND NEW YORK STATE ASSESSMENT**

The provisions of the Company's Electric Bill Credit, as described in General Information Section 36.B, System Benefits Charge, as described in General Information Section 36.A, Renewable Portfolio Standard Charge, as described in General Information Section 36.C, Energy Cost Adjustment Mechanism, as described in General Information Section 29, Merchant Function Charge, as described in General Information Section 36.E, and New York State Assessment, as described in General Information Section 36.F, shall apply to all electricity provided and sold by the Company under this Service Classification. These charges will be based on 45 kWh/month per signal-face of light (as defined above). For billing purposes, the Merchant Function Charge and Electric Bill Credit will be included in the Miscellaneous Charges portion of the Energy Cost Adjustment Mechanism.

**INCREASE IN RATES AND CHARGES**

The prices and charges under this Service Classification, including the Monthly Rate, Electric Bill Credit, System Benefits Charge, Renewable Portfolio Standard Charge, the Energy Cost Adjustment Mechanism, Merchant Function Charge, and New York State Assessment, are increased pursuant to General Information Section 30 to reflect the tax rates applicable within the municipality where the customer takes service.

PSC NO: 15 ELECTRICITY  
 COMPANY: CENTRAL HUDSON GAS & ELECTRIC CORPORATION  
 INITIAL EFFECTIVE DATE: 3/1/2014

STATEMENT TYPE: LED  
 STATEMENT NO: 2

STATEMENT OF LIGHT EMITTING DIODE (LED) FIXTURE DELIVERY RATES

Applicable to billings under Rate C (customer owned and maintained;  
 delivery only) of Service Classification No. 8.

<u>Fixture</u>	<u>Watts Range</u> <sup>1</sup>	<u>Lamp Watts</u> <sup>1</sup>	<u>Annual kWh</u> <sup>2</sup>	<u>Annual Charge</u>	
				<u>Effective</u>	
				<u>March 1, 2014</u>	
LED 25	20 - 30	25	100	\$	13.11
LED 35	30 - 40	35	140	\$	14.66
LED 45	40 - 50	45	180	\$	16.20
LED 55	50 - 60	55	220	\$	17.74
LED 65	60 - 70	65	260	\$	19.29
LED 75	70 - 80	75	300	\$	20.83
LED 85	80 - 90	85	340	\$	22.38
LED 95	90 - 100	95	380	\$	23.92
LED 105	100 - 110	105	420	\$	25.47
LED 215	210 - 220	215	860	\$	42.45

<sup>1</sup> Based on total consumption of lamp and driver.

<sup>2</sup> Pursuant to Service Classification No. 8:

$$\text{Annual kWh} = (\text{Fixture Wattage}/1,000) \times 4,000 \text{ Burning Hours per Year}$$



PSC NO: 15 ELECTRICITY  
COMPANY: CENTRAL HUDSON GAS & ELECTRIC CORPORATION  
INITIAL EFFECTIVE DATE: 01/01/14

LEAF: 168  
REVISION: 6  
SUPERSEDING REVISION: 5

## SERVICE CLASSIFICATION NO. 2

### GENERAL SERVICE

#### APPLICABLE TO USE OF SERVICE FOR

Sales and delivery of electric power supply by the Company or delivery of electric power supply provided by a Retail Supplier to commercial/industrial customers for:

All purposes except use exclusively in individual residences, with the exception of individual residences with three phase service. Also for traffic signals, caution signals and operating control equipment owned, installed and maintained by the State of New York, counties, townships, cities and incorporated villages for which the State of New York has issued the appropriate permits.

Effective March 31, 1991, regardless of the type of service offered, electric service utilized exclusively with such religious purposes or utilized at such community residences, as defined in the Service Classification No. 1 Section entitled Applicable to Use of Service For, shall be charged at rates no greater than the rates or charges applicable to residential customers receiving single phase service.

Effective June 2, 1998, regardless of the type of service offered, electric service utilized by such veteran's organizations, as defined in the Service Classification No. 1 section entitled Applicable to Use of Service For, shall be charged at rates no greater than the rates or charges applicable to residential customers receiving single phase service.

A customer taking three phase primary service and whose demand exceeds 1,000 kW. during two consecutive months of the previous twelve months shall not be eligible for this rate and shall be transferred to Service Classification No. 3. A customer so transferred shall only be eligible for transfer back to Service Classification No. 2 on the annual anniversary of the transfer to Service Classification No. 3 and only if the said customer has not exceeded 1,000 kW. during two consecutive months of the previous twelve months.

#### CHARACTER OF SERVICE

Continuous, 60 cycle, single or three phase alternating current delivered at one secondary voltage or one primary distribution voltage, phase and voltage depending on availability and the customer's requirements.

PSC NO: 15 ELECTRICITY  
 COMPANY: CENTRAL HUDSON GAS & ELECTRIC CORPORATION  
 INITIAL EFFECTIVE DATE: 07/01/10  
 Issued in Compliance with Order in C.09-E-0588 dated June 18, 2010

LEAF: 169  
 REVISION: 14  
 SUPERSEDING REVISION: 13

**SERVICE CLASSIFICATION NO. 2** (Cont'd)

**GENERAL SERVICE** (Cont'd)

**MONTHLY RATE**

<b><u>Non-Demand Metered</u></b>	<b><u>Effective</u></b> <b><u>July 1, 2010</u></b>	<b><u>Effective</u></b> <b><u>July 1, 2011</u></b>	<b><u>Effective</u></b> <b><u>July 1, 2012</u></b>
<u>Customer Charge</u>	\$32.00	\$34.00	\$35.00
<u>Delivery Charges</u>			
Energy Charge per kWh	\$0.00680	\$0.00537	\$0.00588
<b><u>Demand Metered - Secondary Service</u></b>			
<u>Customer Charge</u>	\$63.00	\$73.00	\$84.00
<u>Delivery Charges</u>			
Demand Charge per kW	\$8.00	\$8.07	\$8.10
Energy Charge per kWh	\$0.00535	\$0.00539	\$0.00540
Reactive Demand Charge per Rkva	\$0.83	\$0.83	\$0.83
<b><u>Demand Metered - Primary Service</u></b>			
<u>Customer Charge</u>	\$210.00	\$260.00	\$310.00
<u>Delivery Charges</u>			
Demand Charge per kW	\$6.46	\$6.56	\$6.65
Energy Charge per kWh	\$0.00144	\$0.00146	\$0.00148
Reactive Demand Charge per Rkva	\$0.83	\$0.83	\$0.83

Bills rendered shall be based on periodic meter readings as provided in General Information Section 13.

Customers that exceed 50 kW demand in two consecutive months may elect to obtain metering services from a non-utility provider with a credit applied to their Central Hudson bill. Refer to General Information Section 12.1 and Addendum-MET of the Company's Electric Rate Schedule.

PSC NO: 15 ELECTRICITY  
COMPANY: CENTRAL HUDSON GAS & ELECTRIC CORPORATION  
INITIAL EFFECTIVE DATE: 01/01/14

LEAF: 169.1  
REVISION: 9  
SUPERSEDING REVISION: 8

**SERVICE CLASSIFICATION NO. 2** (Cont'd)

**GENERAL SERVICE** (Cont'd)

**ELECTRIC BILL CREDIT**

The Electric Bill Credit, as described in General Information Section 36.B, shall apply to all customers served under this Service Classification.

**SYSTEM BENEFITS CHARGE**

The System Benefits Charge, as described in General Information Section 36.A, shall apply to all electricity delivered under this Service Classification.

**RENEWABLE PORTFOLIO STANDARD CHARGE**

The Renewable Portfolio Standard Charge, as described in General Information Section 36.C, shall apply to all electricity delivered under this Service Classification.

**PURCHASED POWER ADJUSTMENT AND MISCELLANEOUS CHARGES**

The provisions of the Company's Purchased Power Adjustment and Miscellaneous Charges, as described in General Information Section 29, shall apply to all electricity delivered under this Service Classification.

PSC NO: 15 ELECTRICITY  
COMPANY: CENTRAL HUDSON GAS & ELECTRIC CORPORATION  
INITIAL EFFECTIVE DATE: 04/01/11

LEAF: 169.2  
REVISION: 4  
SUPERSEDING REVISION: 3

**SERVICE CLASSIFICATION NO. 2** (Cont'd)

**GENERAL SERVICE** (Cont'd)

**MARKET PRICE CHARGE AND MARKET PRICE ADJUSTMENT**

The provisions of the Company's Market Price Charge and Market Price Adjustment, as described in General Information Section 29, shall apply to electricity provided and sold by the Company under this Service Classification unless provided under Special Provision 2.11. Customers participating in the Retail Access Program as described in General Information Section 35 shall not be subject to these charges.

**MERCHANT FUNCTION CHARGE**

The Merchant Function Charge, as described in General Information Section 36.E, shall apply to all electricity delivered under this Service Classification.

**NEW YORK STATE ASSESSMENT**

The New York State Assessment, as described in General Information Section 36.F, shall apply to all electricity delivered under this Service Classification.

**REVENUE DECOUPLING MECHANISM**

The Revenue Decoupling Mechanism Adjustment, as described in General Information Section 36.G, shall apply to all electricity delivered under this Service Classification.

**INCREASE IN RATES AND CHARGES**

The rates and charges under this Service Classification, including the minimum charge, Electric Bill Credit, System Benefits Charge, Renewable Portfolio Standard Charge, Purchased Power Adjustment, Miscellaneous Charges, Market Price Charge, Market Price Adjustment, Merchant Function Charge, New York State Assessment and Revenue Decoupling Mechanism, are increased pursuant to General Information Section 30 to reflect the tax rates applicable within the municipality where the customer takes service.

PSC NO: 15 ELECTRICITY  
COMPANY: CENTRAL HUDSON GAS & ELECTRIC CORPORATION  
INITIAL EFFECTIVE DATE: 07/01/11

LEAF: 170  
REVISION: 8  
SUPERSEDING REVISION: 7

SERVICE CLASSIFICATION NO. 2 (Cont'd)

GENERAL SERVICE (Cont'd)

MINIMUM CHARGE

The Customer Charge.

Where the service is supplied from an extension, a surcharge or additional minimum charge may be payable as provided in General Information, Section 5.A.

DETERMINATION OF DEMAND

The demand will be measured whenever the customer's consumption has exceeded 5,000 Kwh. in each of two consecutive bimonthly billing periods or 2,500 Kwh. in each of three consecutive monthly billing periods, during the preceding twelve months; whenever it is estimated the usage of new or existing customers will exceed these amounts in future billing periods; or whenever the demand of new or existing customers is estimated to exceed 10 Kw.

When determined by measurement the demand shall be the highest 15-minute integrated demand established during the month for which the bill is rendered.

The Reactive Demand will be the highest 15-minute integrated kilovoltamperes of lagging reactive demand established during the month less one-third of the highest 15-minute integrated kilowatt demand established during that month.

For customers operating induction generators, reactive demand will be the highest 15-minute integrated kilovoltamperes of lagging reactive demand established during the month less one-third of the highest 15-minute integrated kilowatt generated during that month. In instances where there is no generation or a customer does not fully offset their load in a given month, reactive demand will be calculated in the manner consistent with all other customers.

The Reactive Demand Charge will be effective (a) August 1, 2010 for customers whose demands in any two of the previous twelve months are 1,000 kW or larger, (b) October 1, 2010 for customers with induction generators having a total nameplate rating greater than or equal to 1,000 kW, (c) October 1, 2011 for customers with induction generators having a total nameplate rating greater than or equal to 500 kW and (d) October 1, 2011 for customers whose demands in any two of the previous twelve months are 500 kW or larger.

If elevators, hoists, welding machines or other appliances of widely fluctuating loads are served under this classification, the demand in kilowatts of any installation including such load will not be taken as less than one-half the number of horsepower of the rated capacity of the largest individual elevator or hoist motor or other such appliances.

TERMS OF PAYMENT

Bills are due when personally served or three days after mailing. Bills shall be subject to a late payment charge in accordance with General Information, Section 16, if payment is not made by the date specified on the bill which date shall be not less than 20 days from the due date.

TERM

Terminable at any time provided that customer cannot resume service within twelve months at the same location without paying the reconnection charge set forth in General Information, Section 22.

PSC NO: 15 ELECTRICITY  
COMPANY: CENTRAL HUDSON GAS & ELECTRIC CORPORATION  
INITIAL EFFECTIVE DATE: 01/01/12

LEAF: 171  
REVISION: 11  
SUPERSEDING REVISION: 10

SERVICE CLASSIFICATION NO. 2 (Cont'd)

GENERAL SERVICE (Cont'd)

SPECIAL PROVISIONS

- 2.1 Not in use.
- 2.2 Not in use.
- 2.3 Not in use.

Issued by: Michael L. Mosher, Vice President, Poughkeepsie, New York

..DID: 17605  
..TXT: PSC NO: 15 ELECTRICITY LEAF: 225  
COMPANY: CENTRAL HUDSON GAS & ELECTRIC CORPORATION REVISION: 2  
INITIAL EFFECTIVE DATE: 11/01/01 SUPERSEDING REVISION: 0  
STAMPS: Issued in Compliance with Order in C.00-E-1273 dated October 25, 2001  
RECEIVED: 10/31/01 STATUS: Effective EFFECTIVE: 11/01/01

SERVICE CLASSIFICATION NO. 9

TRAFFIC SIGNAL SERVICE

APPLICABLE TO USE OF SERVICE FOR

This Service Classification is closed to new customers as of November 1, 2001. New customers requiring traffic signal service on and after November 1, 2001 will be required to take metered service under Service Classification No. 2.

Traffic signals, caution signals and operating control equipment owned, installed and maintained by the State of New York, counties, townships, cities and incorporated villages for which the State of New York has issued the appropriate permits, and where the Company has facilities appropriate to the unmetered service.

CHARACTER OF SERVICE

Continuous, 60 cycle, single phase alternating current delivered at 120, 120/208 or 120/240 volts, voltage depending on availability and the customer requirements.

APPLICATION FOR SERVICE

The Company shall require a written application for additional service, which will include the wattage of lamps and associated computation of signal-faces.

TERM

The initial term of service for each signal shall be five years, unless otherwise approved by the Company. Service shall continue in effect thereafter until canceled by either party upon ninety days written notice.

DETERMINATION OF BILLING QUANTITIES

- A. The Company shall estimate the monthly use of the facility serviced hereunder based on the electrical ratings of all equipment installed and the anticipated monthly burning hours. The monthly charge shall be based on this estimate as of the first day of the calendar month. The customer will notify the Company prior to making any changes to an existing installation.
- B. A signal-face of a stop and go signal is defined as a signal or portion of a signal designed to control traffic approaching from a single direction. Each signal-face consists of two or more lenses of which only one is illuminated at any one time with lamps installed having a capacity not exceeding 69 watts per lens, and a control mechanism other than the electromagnetic type.
- C. Lamps simultaneously illuminating a second lens on the face of a stop and go signal will be considered one signal-face.

Issued by: Arthur R. Upright, Senior Vice President, Poughkeepsie, New York

PSC NO: 15 ELECTRICITY  
 COMPANY: CENTRAL HUDSON GAS & ELECTRIC CORPORATION  
 INITIAL EFFECTIVE DATE: 04/01/11

LEAF: 226  
 REVISION: 12  
 SUPERSEDING REVISION: 11

**SERVICE CLASSIFICATION NO. 9** (Cont'd)

**TRAFFIC SIGNAL SERVICE** (Cont'd)

**DETERMINATION OF BILLING QUANTITIES** (Cont'd)

- D. Lamps illuminating fixed or flashing caution lights will be considered one signal-face.
- E. Control mechanisms of the electromagnetic type in excess of 25 watts will be considered one signal-face.
- F. Lamps exceeding 69 watts/lens will be considered one signal-face for the first 69 watts and one additional signal-face for each major fraction thereof.
- G. Walk/Don't Walk pedestrian controls using two lamps will be considered at least one and one-half signal-faces, unless each lamp is larger than 69 watts. If each lamp is larger than 69 watts, the Company will compute the number of signal-faces to be billed.

**MONTHLY RATE**

The price per signal-face of light (as defined above) for electricity supplied is as follows:

	Monthly Charge Effective		
	<u>July 1, 2010</u>	<u>July 1, 2011</u>	<u>July 1, 2012</u>
Monthly Rate per Signal-Face	\$2.76	\$2.86	\$2.96

**ELECTRIC BILL CREDIT SYSTEM BENEFITS CHARGE, RENEWABLE PORTFOLIO STANDARD CHARGE, ENERGY COST ADJUSTMENT MECHANISM, MERCHANT FUNCTION CHARGE, AND NEW YORK STATE ASSESSMENT**

The provisions of the Company's Electric Bill Credit, as described in General Information Section 36.B, System Benefits Charge, as described in General Information Section 36.A, Renewable Portfolio Standard Charge, as described in General Information Section 36.C, Energy Cost Adjustment Mechanism, as described in General Information Section 29, Merchant Function Charge, as described in General Information Section 36.E, and New York State Assessment, as described in General Information Section 36.F, shall apply to all electricity provided and sold by the Company under this Service Classification. These charges will be based on 45 kWh/month per signal-face of light (as defined above). For billing purposes, the Merchant Function Charge and Electric Bill Credit will be included in the Miscellaneous Charges portion of the Energy Cost Adjustment Mechanism.

**INCREASE IN RATES AND CHARGES**

The prices and charges under this Service Classification, including the Monthly Rate, Electric Bill Credit, System Benefits Charge, Renewable Portfolio Standard Charge, the Energy Cost Adjustment Mechanism, Merchant Function Charge, and New York State Assessment, are increased pursuant to General Information Section 30 to reflect the tax rates applicable within the municipality where the customer takes service.



PSC NO: 15 ELECTRICITY LEAF: 226.1  
COMPANY: CENTRAL HUDSON GAS & ELECTRIC CORPORATION REVISION: 0  
INITIAL EFFECTIVE DATE: 10/01/05 SUPERSEDING REVISION:  
Issued in Compliance with Order in C.03-E-0188 dated September 24, 2004

SERVICE CLASSIFICATION NO. 9 (Cont'd)

TRAFFIC SIGNAL SERVICE (Cont'd)

TERMS OF PAYMENT

Bills are due when personally served or three days after mailing. Bills shall be subject to a late payment charge in accordance with General Information, Section 16, if payment is not made by the date specified on the bill which date shall be not less than 20 days from the due date.

..DID: 10714  
..TXT: PSC NO: 15 ELECTRICITY LEAF: 227  
COMPANY: CENTRAL HUDSON GAS & ELECTRIC CORPORATION REVISION: 0  
INITIAL EFFECTIVE DATE: 02/01/00 SUPERSEDING REVISION:  
STAMPS:  
RECEIVED: 12/01/99 STATUS: Effective EFFECTIVE: 02/01/00

SERVICE CLASSIFICATION NO. 9 (Cont'd)

TRAFFIC SIGNAL SERVICE (Cont'd)

SPECIAL PROVISIONS

- A. If an extension is required from an existing underground or overhead circuit to provide service to signal systems, the customer will pay the Company for the costs incurred or install at their cost all footage in excess of 100 feet.
- B. Upon termination of service hereunder, the Company shall have the right within a reasonable time thereafter to remove all facilities placed, installed or used by it pursuant to the service hereunder. Upon making such removal, the Company shall leave the public streets and places affected thereby in the same or as good condition as they were immediately thereto.
- C. The Company shall have the right to remove any Company owned equipment, or to discontinue service to customer owned equipment, which in the opinion of the Company shall have become unsatisfactory for further service by reason of deterioration, civil commotion, state of war, explosion, fire, storm, flood, lightning, or any other cause reasonably beyond the Company's control. Replacement of Company owned equipment shall be limited to equipment considered appropriate by the Company at the date of reinstallation.
- D. The customer shall furnish the Company with all easements or rights-of-way necessary to provide service to the desired location before any installation or construction will be started.
- E. As a condition of receiving service hereunder, the customer authorizes the Company, insofar as it lawfully may, to trim, cut, remove and to keep trimmed, cut and removed any trees and all other obstructions which, in the opinion of the Company, interfere with or may tend to interfere with the construction, operation and maintenance of the Company's service hereunder. Tree trimming required for light distribution on the highway, street and/or sidewalk surfaces is the responsibility of the customer, and shall be done by the customer or at the customer's expense.



City of Beacon Street Lighting Field Record Construction Report-Summary

Fixture Code	Existing (Based on Field Counts)				Replacement			
	EPC QTY	Fixture Type	Lamp Type	Nominal Wattage	Fixture Type	Lamp Type	Nominal Wattage	Model #
HPS70CH-LED25CH	467	Cobra Head	High Pressure Sodium	70	Cobra Head	LED	24	PHILIPS: SVS-25W16LED4K-T-LE2
HPS150CH-LED72CH	208	Cobra Head	High Pressure Sodium	150	Cobra Head	LED	73	PHILIPS: RFM-72W32LED4K-T-R2M
HPS250CH-LED145CH	191	Cobra Head	High Pressure Sodium	250	Cobra Head	LED	137	PHILIPS: RFL-145W64LED4K-R2M
HPS400CH-LED241CH	4	Cobra Head	High Pressure Sodium	400	Cobra Head	LED	248	PHILIPS: RFL-241W112LED4K-T-R2M
MV100CH-LED25CH	17	Cobra Head	Mercury Vapor	100	Cobra Head	LED	25	PHILIPS: SVS-25W16LED4K-T-LE2
MV175CH-LED35CH	257	Cobra Head	Mercury Vapor	175	Cobra Head	LED	36	PHILIPS: SVS-35W16LED4K-T-LE2
MV250CH-LED54CH	3	Cobra Head	Mercury Vapor	250	Cobra Head	LED	54	PHILIPS: SVS-54W16LED4K-T-LE2
MV400CH-LED108CH	3	Cobra Head	Mercury Vapor	400	Cobra Head	LED	106	PHILIPS: RFM-108W48LED4K-R3M
MV400A-LED90PT	60	Acorn	Mercury Vapor	400	Post Top	LED	90	PHILIPS METROSCAPE: MPTR-90W80LED4K-T-LE2-UNIV-PH8-BKTX
MH175A-LED90PT	32	Acorn	Metal Halide	175	Post Top	LED	90	PHILIPS METROSCAPE: MPTR-90W80LED4K-T-LE2-UNIV-PH8-BKTX
HPS70PT-LED35PT	62	Post Top	High Pressure Sodium	70	Post Top	LED	35	PHILIPS METROSCAPE: MPTR-35W32LED4K-T-LE2-UNIV-PH8-BKTX
HPS400PT-LED135PT	52	Post Top	High Pressure Sodium	400	Post Top	LED	135	PHILIPS METROSCAPE: MPTR-135W80LED4K-T-LE2-UNIV-PH8-BKTX
MV175PT-LED48PT	11	Post Top	Mercury Vapor	175	Post Top	LED	48	PHILIPS METROSCAPE: MPTR-48W16LED4K-T-LE2-UNIV-PH8-BKTX
HPS400FL-LED213FL	7	Flood Light	High Pressure Sodium	400	Flood Light	LED	213	PHILIPS CLEARSCAPE: CSFM-64L-1A-NW-G1-YK-A33-UNIV-PCB-BK
HPS250TD-LED80TD	26	Dec. Teardrop	High Pressure Sodium	250	Dec. Teardrop	LED	79	PHILIPS DOMUS: 80W48LED4K-R-LE2F
MH250SB-LED110SB	17	Shoe Box	Metal Halide	250	Shoe Box	LED	110	Philips Form 10: BH19L-1-3-110-NW-UNIV-BLA

City of Beacon Street Lighting Field Record Construction Report

8/20/2015

Street	Approx. Address #	Pole Number	Fixture Code	Light Height (12 - 50)	Sticker Number	Sticker Color	Fixture Type	Quantity (1-10)	Pole Type	Pole Condition	Arm Length	Arm Condition	Notes
Main Street	348		HPS250CH-LED145CH	30	25	Yellow: Sodium vapor lamp	Cobrahead	1	Metal	Good	4 - 8 Ft	Good	
Fishkill Avenue			HPS250CH-LED145CH	25	25	Yellow: Sodium vapor lamp	Cobrahead	1	Wood	Average	4 - 8 Ft	Average	
Wilkes Street	283		HPS150CH-LED72CH	25	15	Yellow: Sodium vapor lamp	Cobrahead	1	Wood	Average	4 - 8 Ft	Average	
Fishkill Avenue		63248	HPS70CH-LED25CH	20	7	Yellow: Sodium vapor lamp	Cobrahead	1	Wood	Average	4 - 8 Ft	Average	
Fishkill Avenue	39	57884	HPS70CH-LED25CH	25	7	Yellow: Sodium vapor lamp	Cobrahead	1	Wood	Good	4 - 8 Ft	Poor	
Deerfield Place	37	55904	HPS150CH-LED72CH	25	15	Yellow: Sodium vapor lamp	Cobrahead	1	Wood	Good	4 - 8 Ft	Average	
Fishkill Avenue	15	49487	HPS70CH-LED25CH	25	7	Yellow: Sodium vapor lamp	Cobrahead	1	Wood	Average	4 - 8 Ft	Average	
Deerfield Place		p49485	HPS150CH-LED72CH	25	15	Yellow: Sodium vapor lamp	Cobrahead	1	Wood	Good	4 - 8 Ft	Poor	
Wilkes Street		107605	MV175CH-LED35CH	25	17	Blue: Mercury vapor	Cobrahead	1	Wood	Good	8 - 12 FT	Average	
Cross Street	65	41087	MV175CH-LED35CH	25	17	Blue: Mercury vapor	Cobrahead	1	Wood	Good	4 - 8 Ft	Average	
Orchard Place		42435	HPS70CH-LED25CH	25	7	Yellow: Sodium vapor lamp	Cobrahead	1	Wood	Good	4 - 8 Ft	Average	
Cross Street		171941	HPS70CH-LED25CH	25	7	Yellow: Sodium vapor lamp	Cobrahead	1	Wood	Good	4 - 8 Ft	Average	
Verplank Avenue		37267	HPS150CH-LED72CH	25	15	Yellow: Sodium vapor lamp	Cobrahead	1	Wood	Good	4 - 8 Ft	Average	
Cross Street		84131	MV175CH-LED35CH	25	17	Blue: Mercury vapor	Cobrahead	1	Wood	Average	4 - 8 Ft	Poor	
Cross Street		23260	MV175CH-LED35CH	25	17	Blue: Mercury vapor	Cobrahead	1	Wood	Average	4 - 8 Ft	Average	No sticker
Dennings Avenue	67	73453	HPS250CH-LED145CH	25	25	Yellow: Sodium vapor lamp	Cobrahead	1	Wood	Average	4 - 8 Ft	Average	
Cross Street		64672	MV175CH-LED35CH	25	17	Blue: Mercury vapor	Cobrahead	1	Wood	Average	4 - 8 Ft	Average	No sticker
Dennings Avenue		73480	MV400PT-LED135PT	25	40	Yellow: Mercury vapor	Cobrahead	1	Wood	Average	4 - 8 Ft	Average	Facing incinerator
Cross Street	15	83511	MV175CH-LED35CH	25	17	Blue: Mercury vapor	Cobrahead	1	Wood	Average	4 - 8 Ft	Average	No sticker
Dennings Avenue		73479	HPS250CH-LED145CH	25	25	Yellow: Sodium vapor lamp	Cobrahead	1	Wood	Good	4 - 8 Ft	Average	
Cross Street		83508	MV175CH-LED35CH	25	17	Blue: Mercury vapor	Cobrahead	1	Wood	Average	4 - 8 Ft	Average	No sticker
Cross Street		23261	HPS250CH-LED145CH	25	25	Yellow: Sodium vapor lamp	Cobrahead	1	Wood	Average	4 - 8 Ft	Good	Parking lot
Dennings Avenue	70	111251	HPS70CH-LED25CH	25	7	Yellow: Sodium vapor lamp	Cobrahead	1	Wood	Good	4 - 8 Ft	Average	
Fishkill Landing	212		HPS70PT-LED35PT	15	7	Yellow: Sodium vapor lamp	Post Top	1	Metal	Average			
Cross Street		24893	HPS250CH-LED145CH	25	25	Yellow: Sodium vapor lamp	Cobrahead	1	Wood	Good	8 - 12 FT	Good	Parking lot
Dennings Avenue	58	24170	MV175CH-LED35CH	25	17	Blue: Mercury vapor	Cobrahead	1	Wood	Average	4 - 8 Ft	Average	
Main Street			HPS400PT-LED135PT	20	40	Yellow: Sodium vapor lamp	Post Top	1	Metal	Average			
Dennings Avenue	36	102352	HPS70CH-LED25CH	30	7	Yellow: Sodium vapor lamp	Cobrahead	1	Wood	Average	4 - 8 Ft	Average	
Fishkill Landing			MV175CH-LED35CH	15	17	Blue: Mercury vapor	Cobrahead	1	Wood	Average			Fiberglass pole
Dennings Avenue	20	102350	HPS70CH-LED25CH	25	7	Yellow: Sodium vapor lamp	Cobrahead	1	Wood	Average	4 - 8 Ft	Average	
North Avenue		149277	HPS250CH-LED145CH	30	25	Yellow: Sodium vapor lamp	Cobrahead	1	Wood	Good	0 - 4 Ft	Average	
Dennings Avenue		51525	MV175CH-LED35CH	25	17	Blue: Mercury vapor	Cobrahead	1	Wood	Average	4 - 8 Ft	Average	
North Avenue			HPS400PT-LED135PT	20	40	Yellow: Sodium vapor lamp	Post Top	1	Metal	Average	4 - 8 Ft	Average	
South Avenue	110		HPS250CH-LED145CH	25	25	Yellow: Sodium vapor lamp	Cobrahead	1	Metal	Average	4 - 8 Ft	Average	
North Avenue		149728	HPS250CH-LED145CH	25	25	Yellow: Sodium vapor lamp	Cobrahead	1	Wood	Good	8 - 12 FT	Average	
Dennings Avenue	9		HPS150CH-LED72CH	30	15	Yellow: Sodium vapor lamp	Cobrahead	1	Metal	Average	4 - 8 Ft	Average	
East Main Street	72		MV175CH-LED35CH	30	17	Blue: Mercury vapor	Cobrahead	1	Wood	Average	4 - 8 Ft	Average	
North Avenue		149729	HPS250CH-LED145CH	30	25	Yellow: Sodium vapor lamp	Cobrahead	1	Wood	Average	8 - 12 FT	Average	
Meadowdale Cir			HPS250CH-LED145CH	30	25	Yellow: Sodium vapor lamp	Cobrahead	1	Metal	Good	8 - 12 FT	Good	
Ralph Street	19	134398	MV175CH-LED35CH	15	17	Blue: Mercury vapor	Cobrahead	1	Wood	Good	4 - 8 Ft	Average	No stick
West Church Street	11	72739	MV175CH-LED35CH	25	17	Blue: Mercury vapor	Cobrahead	1	Wood	Good	0 - 4 Ft	Average	No stick
Hudson Avenue			HPS70CH-LED25CH	7	7	Yellow: Sodium vapor lamp	Cobrahead	1	Average				
West Church Street		34626	MV175CH-LED35CH	25	17	Blue: Mercury vapor	Cobrahead	1	Wood	Average	4 - 8 Ft	Average	No stick
Schenck Avenue			MH175A-LED90PT	15	17	Red: Metal halide	Acorn	2	Metal	Average			
Fishkill Landing	205		HPS70PT-LED35PT	15	7	Yellow: Sodium vapor lamp	Post Top	1	Metal	Average			Fiberglass pole
Dutchess Terrace		75251	MV175CH-LED35CH	15	17	Blue: Mercury vapor	Cobrahead	1	Wood	Good	4 - 8 Ft	Average	No stick
Hudson Avenue	304		HPS70PT-LED35PT	15	7	Yellow: Sodium vapor lamp	Post Top	1	Metal	Good			
Wolcott Avenue			HPS400PT-LED135PT	15	40	Yellow: Sodium vapor lamp	Post Top	1	Metal	Average			Fluted metal pole
Main Street	426		MH175A-LED90PT	15	17	Red: Metal halide	Acorn	2	Metal	Average			
Ralph Street		134395	MV175CH-LED35CH	25	17	Blue: Mercury vapor	Cobrahead	1	Wood	Poor	4 - 8 Ft	Average	No stick
Main Street	436		MH175A-LED90PT	15	17	Red: Metal halide	Acorn	2	Metal	Good			
Hudson Avenue	311		HPS70PT-LED35PT	15	7	Yellow: Sodium vapor lamp	Post Top	1	Metal	Average			Fiberglass pole
Main Street			MH175A-LED90PT	15	17	Red: Metal halide	Acorn	2	Metal	Good			
Ralph Street	3	134395	MV175CH-LED35CH	25	17	Blue: Mercury vapor	Cobrahead	1	Wood	Damaged	4 - 8 Ft	Average	Old pole rotten new pole is placed light needs
Hudson Avenue			HPS70PT-LED35PT	15	7	Yellow: Sodium vapor lamp	Post Top	1	Average				Fiberglass pole
Main Street	468		MH175A-LED90PT	15	17	Red: Metal halide	Acorn	2	Metal	Good			
Hudson Avenue			HPS70PT-LED35PT	15	7	Yellow: Sodium vapor lamp	Post Top	1	Metal	Average			Fiberglass pole
Main Street	478		MH175A-LED90PT	15	17	Red: Metal halide	Acorn	2	Metal	Good			
Main Street	484		MH175A-LED90PT	15	17	Red: Metal halide	Acorn	2	Metal	Good			
Main Street	500		MH175A-LED90PT	15	17	Red: Metal halide	Acorn	2	Metal	Good			
Dennings Avenue	72	141972	MV175CH-LED35CH	25	17	Blue: Mercury vapor	Cobrahead	1	Wood	Average	4 - 8 Ft	Average	
Mackin Avenue	14	30202	MV175CH-LED35CH	20	17	Blue: Mercury vapor	Cobrahead	1	Wood	Good	4 - 8 Ft	Average	No stick
East Main Street	520		HPS150CH-LED72CH	25	15	Yellow: Sodium vapor lamp	Cobrahead	1	Metal	Good	4 - 8 Ft	Average	
Dennings Avenue	74	156155	HPS150CH-LED72CH	25	15	Yellow: Sodium vapor lamp	Cobrahead	1	Wood	Average	8 - 12 FT	Average	
Mackin Avenue		30304	MV175CH-LED35CH	25	17	Blue: Mercury vapor	Cobrahead	1	Wood	Good	4 - 8 Ft	Average	
Main Street					1								
Mackin Avenue	28	40266	MV175CH-LED35CH	20	17	Blue: Mercury vapor	Cobrahead	1	Wood	Poor	4 - 8 Ft	Average	No stick
Dutchess Terrace		102315	HPS70CH-LED25CH	25	7	Yellow: Sodium vapor lamp	Cobrahead	1	Wood	Good	4 - 8 Ft	Average	
Dutchess Terrace	18	134401	HPS70CH-LED25CH	25	7	Yellow: Sodium vapor lamp	Cobrahead	1	Wood	Good	8 - 12 FT	Average	
Verplank Avenue	46	134442	HPS70CH-LED25CH	25	7	Yellow: Sodium vapor lamp	Cobrahead	1	Wood	Average	4 - 8 Ft	Average	
North Street	9	56426P	MV175CH-LED35CH	20	17	Blue: Mercury vapor	Cobrahead	1	Wood	Average	4 - 8 Ft	Average	No sticker on fixture
Sycamore Drive			MV175PT-LED48PT	12	17	Blue: Mercury vapor	Post Top	1	Metal	Average			
Verplank Avenue		78837	HPS70CH-LED25CH	25	7	Yellow: Sodium vapor lamp	Cobrahead	1	Wood	Average	4 - 8 Ft	Average	
Main Street			HPS150CH-LED72CH	30	15	Yellow: Sodium vapor lamp	Cobrahead	1	Metal	Average			
South Avenue	123	27012	MV175CH-LED35CH	25	17	Blue: Mercury vapor	Cobrahead	1	Wood	Good	4 - 8 Ft	Average	
South Avenue	125	27013	HPS70CH-LED25CH	30	7	Yellow: Sodium vapor lamp	Cobrahead	1	Wood	Good	4 - 8 Ft	Average	
Verplank Avenue	21	35585	HPS70CH-LED25CH	25	7	Yellow: Sodium vapor lamp	Cobrahead	1	Wood	Good	4 - 8 Ft	Average	
Sycamore Drive			HPS70PT-LED35PT	12	7	Yellow: Sodium vapor lamp	Post Top	1	Metal	Average			
Sargent Avenue		121264	HPS150CH-LED72CH	30	15	Yellow: Sodium vapor lamp	Cobrahead	1	Metal	Average	4 - 8 Ft	Average	
South Avenue	129	27015	HPS150CH-LED72CH	30	15	Yellow: Sodium vapor lamp	Cobrahead	1	Wood	Good	4 - 8 Ft	Average	
Verplank Avenue	15	134444	HPS70CH-LED25CH	25	7	Yellow: Sodium vapor lamp	Cobrahead	1	Wood	Good	4 - 8 Ft	Average	
Verplank Avenue	9	134443	MV175CH-LED35CH	25	17	Blue: Mercury vapor	Cobrahead	1	Wood	Good	4 - 8 Ft	Average	No sticker color
South Avenue	135	27017	HPS150CH-LED72CH	30	15	Yellow: Sodium vapor lamp	Cobrahead	1	Wood	Average	4 - 8 Ft	Average	
South Avenue	137	27019	HPS70CH-LED25CH	30	7	Yellow: Sodium vapor lamp	Cobrahead	1	Wood	Average	4 - 8 Ft	Average	
South Avenue	149	27021	HPS70CH-LED25CH	30	7	Yellow: Sodium vapor lamp	Cobrahead	1	Wood	Average	4 - 8 Ft	Average	
Talbot Avenue	12	72348	HPS70CH-LED25CH	40	7	Yellow: Sodium vapor lamp	Cobrahead	1	Wood	Good	4 - 8 Ft	Average	
South Avenue	155	27025	HPS70CH-LED25CH	40	7	Yellow: Sodium vapor lamp	Cobrahead	1	Wood	Average	4 - 8 Ft	Average	
Main Street			HPS150CH-LED72CH	20	15	Yellow: Sodium vapor lamp	Cobrahead	1	Metal	Average			
Dutchess Terrace	29	134403	HPS70CH-LED25CH	25	7	Yellow: Sodium vapor lamp	Cobrahead	1	Wood	Good	4 - 8 Ft	Average	
South Avenue	169	27033	HPS70CH-LED25CH	40	7	Yellow: Sodium vapor lamp	Cobrahead	1	Wood	Good	8 - 12 FT	Average	
South Avenue	197	27039	HPS70CH-LED25CH	30	7	Yellow: Sodium vapor lamp	Cobrahead	1	Wood	Good	4 - 8 Ft	Average	
Dutchess Terrace	58	134407	MV175CH-LED35CH	25	17	Blue: Mercury vapor	Cobrahead	1	Wood	Average	4 - 8 Ft	Average	No stick
South Avenue		27105	HPS150CH-LED72CH	30	15	Yellow: Sodium vapor lamp	Cobrahead	1	Wood	Good	4 - 8 Ft	Average	
Main Street	476	35669	HPS250CH-LED145CH	25	25	Yellow: Sodium vapor lamp	Cobrahead	1	Wood	Average	4 - 8 Ft	Average	
Swens Place	9	149878	HPS70CH-LED25CH	25	7	Yellow: Sodium vapor lamp	Cobrahead	1	Wood	Good	4 - 8 Ft	Average	
Main Street			HPS150CH-LED72CH	25	15	Yellow: Sodium vapor lamp	Cobrahead	1	Wood	Good	4 - 8 Ft	Average	
Main Street		143185	HPS150CH-LED72CH	25	15	Yellow: Sodium vapor lamp	Cobrahead	1	Wood	Average	4 - 8 Ft	Average	Tree service needed
Sargent Avenue		143501	HPS70CH-LED25CH	30									

Main Street			MH175A-LED90PT	15	17	Red: Metal halide	Acorn	3	Metal	Average				
Dutchess Terrace	50	134406	HPS70CH-LED25CH	25	7	Yellow: Sodium vapor lamp	Cobrahead	1	Wood	Average	4-8 Ft	Average		
Main Street		143689	HPS70CH-LED25CH	25	7	Yellow: Sodium vapor lamp	Cobrahead	1	Wood	Average	4-8 Ft	Average		
Sargent Avenue		163062	HPS150CH-LED72CH	30	15	Yellow: Sodium vapor lamp	Cobrahead	1	Wood	Good	4-8 Ft	Average		
Sargent Avenue		24172	HPS150CH-LED72CH	25	15	Yellow: Sodium vapor lamp	Cobrahead	1	Wood	Average	4-8 Ft	Average		
Sargent Avenue	176	55230	HPS150CH-LED72CH	25	15	Yellow: Sodium vapor lamp	Cobrahead	1	Wood	Average	4-8 Ft	Average		
Silvers Place		105055	HPS70CH-LED25CH	25	7	Yellow: Sodium vapor lamp	Cobrahead	1	Wood	Good	4-8 Ft	Average		
Sargent Avenue	153	25376	HPS70CH-LED25CH	25	7	Yellow: Sodium vapor lamp	Cobrahead	1	Wood	Average	4-8 Ft	Average		
Sargent Avenue	145	121269	HPS70CH-LED25CH	30	7	Yellow: Sodium vapor lamp	Cobrahead	1	Wood	Average	4-8 Ft	Average		
Dutchess Terrace		134408	MV175CH-LED35CH	25	17	Blue: Mercury vapor	Cobrahead	1	Wood	Average	4-8 Ft	Average	No stick	
Main Street	534		HPS250CH-LED145CH	30	25	Yellow: Sodium vapor lamp	Cobrahead	1	Wood	Average	4-8 Ft	Average		
Rock Hill Road		77953	HPS250CH-LED145CH	30	25	Yellow: Sodium vapor lamp	Cobrahead	1	Wood	Average	8-12 FT	Average		
Main Street	544		HPS250CH-LED145CH	20	25	Yellow: Sodium vapor lamp	Cobrahead	1	Wood	Average	4-8 Ft	Average		
Main Street			HPS400CH-LED35PT	20	40	Yellow: Sodium vapor lamp	Cobrahead	1	Wood	Average	0-4 Ft	Average		
North Avenue		149749	HPS250CH-LED145CH	30	25	Yellow: Sodium vapor lamp	Cobrahead	1	Wood	Good	8-12 FT	Average		
South Wodeneth Drive		67292	MV175CH-LED35CH	25	17	Blue: Mercury vapor	Other	1	Wood	Average	8-12 FT	Average	Dusk to dawn Can be replaced with cobra	
Verplank Avenue		51725	MV175CH-LED35CH	25	17	Blue: Mercury vapor	Cobrahead	1	Wood	Average	4-8 Ft	Average	No sticker on future	
Wodeneth Drive	59	67298	HPS150CH-LED72CH	25	15	Yellow: Sodium vapor lamp	Cobrahead	1	Wood	Average	8-12 FT	Average		
Dutchess Terrace	80	60953	HPS70CH-LED25CH	25	7	Yellow: Sodium vapor lamp	Cobrahead	1	Wood	Average	4-8 Ft	Average		
Ellen Drive	8		HPS70PT-LED35PT	15	7	Yellow: Sodium vapor lamp	Post Top	1	Wood	Average				
Wodeneth Drive		p67296	HPS70CH-LED25CH	25	7	Yellow: Sodium vapor lamp	Cobrahead	1	Wood	Average	8-12 FT	Average	Square pole	
Verplank Avenue	12	60773	HPS70CH-LED25CH	20	7	Yellow: Sodium vapor lamp	Cobrahead	1	Wood	Good	4-8 Ft	Average		
Sycamore Drive			MV175PT-LED48PT	12	17	Blue: Mercury vapor	Post Top	1	Metal	Average				
Kristy Drive			HPS70PT-LED35PT	15	7	Yellow: Sodium vapor lamp	Post Top	1	Wood	Average			Square pole	
Sycamore Drive			MV175PT-LED48PT	12	17	Blue: Mercury vapor	Post Top	1	Metal	Average				
Sycamore Drive			MV175PT-LED48PT	12	17	Blue: Mercury vapor	Post Top	1	Metal	Average				
Wilkes Street		134834	HPS70CH-LED25CH	25	7	Yellow: Sodium vapor lamp	Cobrahead	1	Wood	Good	4-8 Ft	Average		
West Willow Street	36	64688	HPS70CH-LED25CH	25	7	Yellow: Sodium vapor lamp	Cobrahead	1	Wood	Good	4-8 Ft	Average		
Beskin Place	19	83510	HPS70CH-LED25CH	30	7	Yellow: Sodium vapor lamp	Cobrahead	1	Wood	Average	4-8 Ft	Average		
West Willow Street	34	63500	HPS70CH-LED25CH	22	7	Yellow: Sodium vapor lamp	Cobrahead	1	Wood	Good	4-8 Ft	Average		
West Willow Street	85	66257	HPS250CH-LED145CH	25	7	Yellow: Sodium vapor lamp	Cobrahead	1	Wood	Good	4-8 Ft	Average		
Coffey Avenue	23	80396	HPS70CH-LED25CH	25	7	Yellow: Sodium vapor lamp	Cobrahead	1	Wood	Average	4-8 Ft	Average		
West Willow Street	103	70376	HPS70CH-LED25CH	25	7	Yellow: Sodium vapor lamp	Cobrahead	1	Wood	Good	4-8 Ft	Average		
Coffey Avenue	19	134481	HPS70CH-LED25CH	30	7	Yellow: Sodium vapor lamp	Cobrahead	1	Wood	Average	4-8 Ft	Average		
Aldridge Place	7	155123	HPS70CH-LED25CH	30	7	Yellow: Sodium vapor lamp	Cobrahead	1	Wood	Average	4-8 Ft	Average		
East Willow Street			MV175CH-LED35CH	25	17	Blue: Mercury vapor	Cobrahead	1	Wood	Average				
East Willow Street	118	57774	HPS150CH-LED72CH	25	15	Yellow: Sodium vapor lamp	Cobrahead	1	Wood	Good	4-8 Ft	Average	No stick	
Coffey Avenue	7	134480	HPS150CH-LED72CH	30	15	Yellow: Sodium vapor lamp	Cobrahead	1	Wood	Average	4-8 Ft	Average		
East Willow Street	100	57776	MV175CH-LED35CH	25	17	Blue: Mercury vapor	Cobrahead	1	Wood	Good	4-8 Ft	Average	No stick	
Wolcott Avenue		126635	MV175CH-LED35CH	25	17	Blue: Mercury vapor	Cobrahead	1	Wood	Average	4-8 Ft	Average		
Wolcott Avenue	94	134464	HPS70CH-LED25CH	30	7	Yellow: Sodium vapor lamp	Cobrahead	1	Wood	Average	4-8 Ft	Average		
East Willow Street	88	57784	MV175CH-LED35CH	25	17	Blue: Mercury vapor	Cobrahead	1	Wood	Good	4-8 Ft	Average	No sticker photo cell out so light is on appeal	
South Chestnut Street	954	40229	HPS70CH-LED25CH	25	7	Yellow: Sodium vapor lamp	Cobrahead	1	Wood	Average	4-8 Ft	Average		
East Willow Street	70	57780	MV250CH-LED54CH	25	25	Blue: Mercury vapor	Cobrahead	1	Wood	Good	4-8 Ft	Average	No stick	
Wolcott Avenue		125636	MV175CH-LED35CH	25	17	Blue: Mercury vapor	Cobrahead	1	Wood	Average	4-8 Ft	Average		
East Willow Street	60	57782	HPS70CH-LED25CH	30	7	Yellow: Sodium vapor lamp	Cobrahead	1	Wood	Good	4-8 Ft	Average		
Wolcott Avenue		134467	HPS70CH-LED25CH	30	7	Yellow: Sodium vapor lamp	Cobrahead	1	Wood	Average	4-8 Ft	Average		
East Willow Street	34	57784	MV175CH-LED35CH	25	17	Blue: Mercury vapor	Cobrahead	1	Wood	Good	4-8 Ft	Average	No stick	
Wolcott Avenue		36404	MV175CH-LED35CH	30	17	Blue: Mercury vapor	Cobrahead	1	Wood	Average	4-8 Ft	Average		
Wilkes Street		134833	HPS70CH-LED25CH	25	7	Yellow: Sodium vapor lamp	Cobrahead	1	Wood	Good	4-8 Ft	Average		
Unnamed Street			HPS250CH-LED145CH	30	25	Yellow: Sodium vapor lamp	Cobrahead	1	Wood	Average	4-8 Ft	Average		
Wolcott Avenue		134470	HPS150CH-LED72CH	30	15	Yellow: Sodium vapor lamp	Cobrahead	1	Wood	Average	8-12 FT	Average		
Wolcott Avenue			HPS250CH-LED145CH	25	25	Yellow: Sodium vapor lamp	Cobrahead	1	Metal	Good	4-8 Ft	Average		
South Avenue			HPS250CH-LED145CH	30	25	Yellow: Sodium vapor lamp	Cobrahead	1	Metal	Average	4-8 Ft	Average		
South Avenue			HPS250CH-LED145CH	30	25	Yellow: Sodium vapor lamp	Cobrahead	1	Metal	Average	4-8 Ft	Average		
North Street		52361	MV175CH-LED35CH	20	17	Blue: Mercury vapor	Cobrahead	1	Wood	Good	4-8 Ft	Average	No sticker	
North Street	42		HPS250CH-LED145CH	25	25	Yellow: Sodium vapor lamp	Cobrahead	1	Wood	Good	4-8 Ft	Average		
Sargent Avenue	80	66789	HPS150CH-LED72CH	25	15	Yellow: Sodium vapor lamp	Cobrahead	1	Wood	Good	4-8 Ft	Average		
Jordan Road		75963	HPS70PT-LED35PT	15	7	Yellow: Sodium vapor lamp	Post Top	1	Wood	Good			Square pole	
Jordan Road	3	75964	HPS70PT-LED35PT	15	7	Yellow: Sodium vapor lamp	Post Top	1	Wood	Average			Square pole	
Jordan Road		75965	HPS70PT-LED35PT	15	7	Yellow: Sodium vapor lamp	Post Top	1	Wood	Average			Square pole	
Iris Circle		75966	HPS70PT-LED35PT	15	7	Yellow: Sodium vapor lamp	Post Top	1	Wood	Average			Square pole	
Iris Circle			HPS70CH-LED25CH	25	7	Yellow: Sodium vapor lamp	Post Top	1	Wood	Average			Square pole	
North Avenue		35324	HPS250CH-LED145CH	30	25	Yellow: Sodium vapor lamp	Cobrahead	1	Wood	Average	8-12 FT	Average		
North Avenue		149745	HPS250CH-LED145CH	30	25	Yellow: Sodium vapor lamp	Cobrahead	1	Wood	Good	8-12 FT	Average		
Iris Circle	24	75969	HPS70PT-LED35PT	15	7	Yellow: Sodium vapor lamp	Post Top	1	Wood	Average			Square pole	
Barrett Place		149743	HPS250CH-LED145CH	30	25	Yellow: Sodium vapor lamp	Cobrahead	1	Wood	Good	8-12 FT	Average		
North Avenue		149742	HPS250CH-LED145CH	30	25	Yellow: Sodium vapor lamp	Cobrahead	1	Wood	Average	8-12 FT	Average		
Iris Circle	37	75971	HPS70PT-LED35PT	15	7	Yellow: Sodium vapor lamp	Post Top	1	Wood	Average				
North Avenue			HPS250CH-LED145CH	30	25	Yellow: Sodium vapor lamp	Cobrahead	1	Wood	Good	8-12 FT	Average		
North Avenue			HPS250CH-LED145CH	30	25	Yellow: Sodium vapor lamp	Cobrahead	1	Wood	Good	8-12 FT	Average		
Lafayette Avenue	1203	149737	HPS250CH-LED145CH	30	25	Yellow: Sodium vapor lamp	Cobrahead	1	Wood	Good	8-12 FT	Average		
Victor Rd	40	186351	HPS70PT-LED35PT	15	7	Yellow: Sodium vapor lamp	Post Top	1	Metal	Average				
North Avenue		149734	HPS250CH-LED145CH	30	25	Yellow: Sodium vapor lamp	Cobrahead	1	Wood	Good	8-12 FT	Average		
Victor Rd	36	186350	HPS70PT-LED35PT	15	7	Yellow: Sodium vapor lamp	Post Top	1	Metal	Average				
Victor Rd	34	186349	HPS70PT-LED35PT	15	7	Yellow: Sodium vapor lamp	Post Top	1	Metal	Average				
South Street		142128	MV175CH-LED35CH	25	17	Blue: Mercury vapor	Cobrahead	1	Wood	Average	4-8 Ft	Average	No sticker	
North Avenue		149731	HPS250CH-LED145CH	30	25	Yellow: Sodium vapor lamp	Cobrahead	1	Wood	Average	8-12 FT	Average		
Victor Road	18	75976	HPS70PT-LED35PT	15	7	Yellow: Sodium vapor lamp	Post Top	1	Wood	Average			Square pole	
South Street	17		HPS70CH-LED25CH	25	7	Yellow: Sodium vapor lamp	Cobrahead	2	Wood	Average	4-8 Ft	Average	Other fixture was #25 / yellow sticker	
Wolcott Avenue			HPS400PT-LED135PT	20	40	Yellow: Sodium vapor lamp	Post Top	1	Metal	Average				
South Street	10	23125	HPS70CH-LED25CH	30	7	Yellow: Sodium vapor lamp	Cobrahead	1	Wood	Average	4-8 Ft	Average		
Victor Road		75982	HPS70PT-LED35PT	15	7	Yellow: Sodium vapor lamp	Post Top	1	Wood	Average			Square pole	
Driveaway			HPS400PT-LED135PT	20	40	Yellow: Sodium vapor lamp	Post Top	1	Metal	Average				
Wolcott Avenue		74875	HPS400PT-LED135PT	20	40	Yellow: Sodium vapor lamp	Post Top	1	Metal	Average				
Victor Road			HPS70CH-LED25CH	25	7	Yellow: Sodium vapor lamp	Post Top	1	Wood	Average			Square pole	
Wolcott Avenue			HPS400PT-LED135PT	20	40	Yellow: Sodium vapor lamp	Post Top	1	Metal	Average				
Wolcott Avenue		74873	HPS400PT-LED135PT	20	40	Yellow: Sodium vapor lamp	Post Top	1	Metal	Average				
South Street	5	23147	HPS70CH-LED25CH	20	7	Yellow: Sodium vapor lamp	Cobrahead	1	Wood	Average	4-8 Ft	Good		
Wolcott Avenue			HPS400PT-LED135PT	20	40	Yellow: Sodium vapor lamp	Post Top	1	Metal	Average				
Wolcott Avenue			HPS400PT-LED135PT	20	40	Yellow: Sodium vapor lamp	Post Top	1	Metal	Average				
Wolcott Avenue			HPS400PT-LED135PT	20	40	Yellow: Sodium vapor lamp	Post Top	1	Metal	Average				
Academy Street			HPS400PT-LED135PT	20	40	Yellow: Sodium vapor lamp	Post Top	1	Metal	Average				
Phillips Street	57	74270	HPS70CH-LED25CH	30	7	Yellow: Sodium vapor lamp	Cobrahead	1	Wood	Average	4-8 Ft	Average		
Wolcott Avenue		74863	HPS400PT-LED135PT	20	40	Yellow: Sodium vapor lamp	Post Top	1	Metal	Average				
Ackerman Street	54	134310	HPS70CH-LED25CH	20	7	Yellow: Sodium vapor lamp	Cobrahead	1	Wood	Average	4-8 Ft	Average		
Phillips Street	67	149735	HPS70CH-LED25CH	25	7	Yellow: Sodium vapor lamp	Cobrahead	1	Wood	Good	4-8 Ft	Average		
Phillips Street	75	83868	HPS70CH-LED25CH	30	7	Yellow: Sodium vapor lamp	Cobrahead	1	Wood	Average	4-8 Ft	Average		
Ackerman Street		40927	MV175CH-LED35CH	20	17	Blue: Mercury vapor	Cobrahead	1	Wood	Average	4-8 Ft	Average	No sticker	
Tracy Drive	5		HPS70PT-LED35PT	15	7	Yellow: Sodium vapor lamp	Post Top	1	Wood	Average			Square pole	
Rombout Avenue		67216	HPS70CH-LED25CH	25	7	Yellow: Sodium vapor lamp	Cobrahead	1	Wood	Good	4-8 Ft	Average		
Iris Circle		75968	HPS70PT-LED35PT	15	7	Yellow: Sodium vapor lamp	Post Top	1	Wood	Average			Square pole	
North Street	19	134291	MV175CH-LED35CH	20	17	Blue: Mercury vapor	Cobrahead	1	Wood	Average	4-8 Ft	Average	No sticker	
North Avenue	1242	149744	HPS250CH-LED145CH	30	25	Yellow: Sodium vapor lamp	Cobrahead	1	Wood	Good	8-12 FT	Average		
Iris Circle		75970	HPS70PT-LED35PT	15	7	Yellow: Sodium vapor lamp	Post Top	1	Wood	Average			Square pole	
Iris Circle	41	75972	HPS70PT-LED35PT	15	7	Yellow: Sodium vapor lamp	Post Top	1	Wood	Average			Square pole	
North Avenue			HPS250CH-LED145CH	30	25	Yellow: Sodium vapor lamp	Cobrahead	1	Wood	Good	8-12 FT	Average		
Iris Circle	46	75973	HPS70PT-LED35PT	15	7	Yellow: Sodium vapor lamp	Post Top	1	Wood	Average			Square pole	
Victor Rd	37	186352	HPS70PT-LED35PT	15	7	Yellow: Sodium vapor lamp	Post Top	1	Metal	Average				
South Street	12	52363	MV175CH-LED35CH	20	17	Blue: Mercury vapor	Cobrahead	1	Wood	Average	4-8 Ft	Poor	No sticker	
North Avenue		149736	HPS250CH-LED145CH											

Tracy Drive	22		HPS70PT-LED35PT	15	7	Yellow: Sodium vapor lamp	Post Top	1	Wood	Average	4-8 Ft	Average	Square pole
Rombout Avenue	37	27057	HPS70CH-LED25CH	25	7	Yellow: Sodium vapor lamp	Cobrahead	1	Wood	Average	4-8 Ft	Average	Square pole
Ellen Drive	19		HPS70PT-LED35PT	15	7	Yellow: Sodium vapor lamp	Post Top	1	Wood	Average	4-8 Ft	Average	Square pole
Rombout Avenue	41	62295	HPS150CH-LED72CH	25	15	Yellow: Sodium vapor lamp	Cobrahead	1	Wood	Good	4-8 Ft	Average	Square pole
Ellen Drive	15		HPS70PT-LED35PT	15	7	Yellow: Sodium vapor lamp	Post Top	1	Wood	Poor	4-8 Ft	Average	Square pole
Academy Street		142182	HPS70CH-LED25CH	25	7	Yellow: Sodium vapor lamp	Cobrahead	1	Wood	Good	4-8 Ft	Average	Square pole
Davis Street	12	60773	HPS70CH-LED25CH	25	7	Yellow: Sodium vapor lamp	Cobrahead	1	Wood	Good	4-8 Ft	Average	Square pole
Academy Street	8	61145	MV175CH-LED35CH	20	17	Blue: Mercury vapor	Cobrahead	1	Wood	Good	4-8 Ft	Average	Square pole
Kristy Drive		73794	HPS70PT-LED35PT	15	7	Yellow: Sodium vapor lamp	Post Top	1	Wood	Average	4-8 Ft	Average	Square pole
Kristy Drive			HPS70PT-LED35PT	15	7	Yellow: Sodium vapor lamp	Post Top	1	Wood	Average	4-8 Ft	Average	Square pole
South Avenue	42	27049	HPS150CH-LED72CH	25	15	Yellow: Sodium vapor lamp	Cobrahead	1	Wood	Average	4-8 Ft	Average	Square pole
South Avenue	25	27047	HPS150CH-LED72CH	25	15	Yellow: Sodium vapor lamp	Cobrahead	1	Wood	Average	4-8 Ft	Average	Square pole
Crescent Drive	35	83487	HPS70CH-LED25CH	30	7	Yellow: Sodium vapor lamp	Cobrahead	1	Wood	Average	4-8 Ft	Average	Square pole
Crescent Drive	31	83468	HPS150CH-LED72CH	30	17	Blue: Mercury vapor	Cobrahead	1	Wood	Average	4-8 Ft	Average	Square pole
South Avenue		107501	HPS250CH-LED145CH	25	25	Yellow: Sodium vapor lamp	Cobrahead	1	Wood	Good	4-8 Ft	Average	Square pole
Crescent Drive	32	83489	MV175CH-LED35CH	30	17	Blue: Mercury vapor	Cobrahead	1	Wood	Average	4-8 Ft	Average	Square pole
Crescent Drive	28	83490	HPS70CH-LED25CH	30	7	Yellow: Sodium vapor lamp	Cobrahead	1	Wood	Average	4-8 Ft	Average	Square pole
Beacon Street		134379	HPS70CH-LED25CH	25	7	Yellow: Sodium vapor lamp	Cobrahead	1	Wood	Good	4-8 Ft	Average	Square pole
Beacon Street			HPS70CH-LED25CH	25	7	Yellow: Sodium vapor lamp	Cobrahead	1	Wood	Average	4-8 Ft	Average	Square pole
Crescent Drive	22	83491	HPS70CH-LED25CH	30	7	Yellow: Sodium vapor lamp	Cobrahead	1	Wood	Average	4-8 Ft	Average	Square pole
Schenck Avenue	61	37500	MV175CH-LED35CH	20	17	Blue: Mercury vapor	Cobrahead	1	Wood	Average	4-8 Ft	Average	Square pole
Crescent Drive	20	83492	MV175CH-LED35CH	30	17	Blue: Mercury vapor	Cobrahead	1	Wood	Average	4-8 Ft	Average	Square pole
South Avenue		134369	HPS150CH-LED72CH	25	15	Yellow: Sodium vapor lamp	Cobrahead	1	Wood	Average	4-8 Ft	Average	Square pole
South Avenue		134370	MV400CH-LED108CH	30	40	Blue: Mercury vapor	Cobrahead	1	Wood	Average	4-8 Ft	Average	Square pole
Schenck Avenue			MV175CH-LED35CH	30	17	Blue: Mercury vapor	Cobrahead	1	Wood	Average	4-8 Ft	Average	Square pole
South Avenue		35960	HPS250CH-LED145CH	25	25	Yellow: Sodium vapor lamp	Cobrahead	1	Wood	Good	4-8 Ft	Average	Square pole
Crescent Drive		76060	HPS70CH-LED25CH	30	7	Yellow: Sodium vapor lamp	Cobrahead	1	Wood	Average	4-8 Ft	Average	Square pole
Crescent Drive	11	76059	HPS70CH-LED25CH	30	7	Yellow: Sodium vapor lamp	Cobrahead	1	Wood	Average	4-8 Ft	Average	Square pole
South Avenue			HPS250CH-LED145CH	25	25	Yellow: Sodium vapor lamp	Cobrahead	1	Wood	Average	4-8 Ft	Average	Square pole
Rende Drive	37	76050	MV100CH-LED25CH	25	10	Blue: Mercury vapor	Cobrahead	1	Wood	Average	4-8 Ft	Average	Square pole
South Avenue			HPS400PT-LED135PT	20	40	Yellow: Sodium vapor lamp	Post Top	1	Metal	Average	4-8 Ft	Average	Square pole
Wolcott Avenue			HPS400PT-LED135PT	20	40	Yellow: Sodium vapor lamp	Post Top	1	Metal	Average	4-8 Ft	Average	Square pole
Crescent Drive	5	76058	MV100CH-LED25CH	30	10	Blue: Mercury vapor	Cobrahead	1	Wood	Average	4-8 Ft	Average	Square pole
Crescent Drive	2	76057	HPS70CH-LED25CH	30	7	Yellow: Sodium vapor lamp	Cobrahead	1	Wood	Average	4-8 Ft	Average	Square pole
Schenck Avenue		68581	HPS70CH-LED25CH	30	7	Yellow: Sodium vapor lamp	Cobrahead	1	Wood	Average	4-8 Ft	Average	Square pole
Rende Drive	20	74297	MV100CH-LED25CH	30	10	Blue: Mercury vapor	Cobrahead	1	Wood	Average	4-8 Ft	Average	Square pole
Rende Drive		74280	MV100CH-LED25CH	30	10	Blue: Mercury vapor	Cobrahead	1	Wood	Average	4-8 Ft	Average	Square pole
Rende Drive		74281	MV100CH-LED25CH	30	10	Blue: Mercury vapor	Cobrahead	1	Wood	Average	4-8 Ft	Average	Square pole
Beekman Street			HPS250CH-LED145CH	30	25	Yellow: Sodium vapor lamp	Cobrahead	1	Metal	Good	8-12 FT	Good	Square pole
Rende Drive		74282	MV100CH-LED25CH	30	10	Blue: Mercury vapor	Cobrahead	1	Wood	Average	4-8 Ft	Average	Square pole
Beekman Street			HPS250CH-LED145CH	25	25	Yellow: Sodium vapor lamp	Cobrahead	1	Metal	Good	8-12 FT	Good	Square pole
Rende Drive			MV100CH-LED25CH	30	10	Blue: Mercury vapor	Cobrahead	1	Wood	Average	4-8 Ft	Average	Square pole
Beekman Street			HPS250CH-LED145CH	25	25	Yellow: Sodium vapor lamp	Cobrahead	1	Metal	Good	8-12 FT	Good	Square pole
Beekman Street			HPS250CH-LED145CH	25	25	Yellow: Sodium vapor lamp	Cobrahead	1	Metal	Good	8-12 FT	Good	Square pole
Beekman Street			HPS250CH-LED145CH	25	25	Yellow: Sodium vapor lamp	Cobrahead	1	Metal	Good	8-12 FT	Good	Square pole
Rende Drive	18	74278	HPS70CH-LED25CH	30	7	Yellow: Sodium vapor lamp	Cobrahead	1	Wood	Average	4-8 Ft	Average	Square pole
Rende Drive	16	74277	MV100CH-LED25CH	30	10	Blue: Mercury vapor	Cobrahead	1	Wood	Average	4-8 Ft	Average	Square pole
Beekman Street			HPS250CH-LED145CH	30	25	Yellow: Sodium vapor lamp	Cobrahead	1	Metal	Good	8-12 FT	Good	Square pole
West Main Street		70309	HPS250CH-LED145CH	20	25	Yellow: Sodium vapor lamp	Cobrahead	1	Wood	Average	4-8 Ft	Average	Square pole
Heaney Drive		79079	HPS150CH-LED72CH	30	15	Yellow: Sodium vapor lamp	Cobrahead	1	Wood	Average	4-8 Ft	Average	Square pole
Heaney Drive	10	79080	MV100CH-LED25CH	30	10	Blue: Mercury vapor	Cobrahead	1	Wood	Average	4-8 Ft	Average	Square pole
Branch Street			MV175CH-LED35CH	25	17	Blue: Mercury vapor	Cobrahead	1	Wood	Average	4-8 Ft	Average	Square pole
Heaney Drive	22	83865	HPS70CH-LED25CH	30	7	Yellow: Sodium vapor lamp	Cobrahead	1	Wood	Average	4-8 Ft	Average	Square pole
Heaney Drive	32	83867	HPS70CH-LED25CH	30	7	Yellow: Sodium vapor lamp	Cobrahead	1	Wood	Average	4-8 Ft	Average	Square pole
Bank Street	16	125646	MV175CH-LED35CH	25	17	Blue: Mercury vapor	Cobrahead	1	Wood	Good	4-8 Ft	Average	Square pole
Bank Street		129830	HPS70CH-LED25CH	25	7	Yellow: Sodium vapor lamp	Cobrahead	1	Wood	Average	4-8 Ft	Average	Square pole
Schofield Place		81566	HPS70CH-LED25CH	30	7	Yellow: Sodium vapor lamp	Cobrahead	1	Wood	Average	4-8 Ft	Average	Square pole
Bank Street	32	129881	HPS70CH-LED25CH	25	7	Yellow: Sodium vapor lamp	Cobrahead	1	Wood	Average	4-8 Ft	Average	Square pole
Teller Avenue			HPS250CH-LED145CH	30	25	Yellow: Sodium vapor lamp	Cobrahead	1	Metal	Average	8-12 FT	Good	Parking lot
Teller Avenue			HPS250CH-LED145CH	30	25	Yellow: Sodium vapor lamp	Cobrahead	2	Metal	Average	8-12 FT	Good	Parking lot
Henry Street			HPS250CH-LED145CH	30	25	Yellow: Sodium vapor lamp	Cobrahead	2	Metal	Average	8-12 FT	Good	Parking lot
Henry Street			HPS250CH-LED145CH	30	25	Yellow: Sodium vapor lamp	Cobrahead	1	Metal	Average	8-12 FT	Good	Parking lot
Schofield Place		81557	HPS70CH-LED25CH	30	7	Yellow: Sodium vapor lamp	Cobrahead	1	Wood	Good	4-8 Ft	Average	Square pole
Pearse Place		79078	MV100CH-LED25CH	30	10	Blue: Mercury vapor	Cobrahead	1	Wood	Good	4-8 Ft	Average	Square pole
Rende Drive	7	74278	MV100CH-LED25CH	30	10	Blue: Mercury vapor	Cobrahead	1	Wood	Good	4-8 Ft	Average	Square pole
Main Street	554		HPS400FL-LED213FL	20	40	Yellow: Sodium vapor lamp	Floodlight	1	Wood	Poor	0-4 Ft	Average	NEW pole has been installed
Falconer Street		134513	MV175CH-LED35CH	30	17	Blue: Mercury vapor	Cobrahead	1	Wood	Average	4-8 Ft	Average	NEW pole installed
Main Street		141526	HPS150CH-LED72CH	30	15	Yellow: Sodium vapor lamp	Cobrahead	1	Wood	Poor	4-8 Ft	Average	NEW pole installed
East Main Street		141527	MV175CH-LED35CH	30	17	Blue: Mercury vapor	Cobrahead	1	Wood	Average	4-8 Ft	Average	NEW pole installed
Main Street		134506	MV175CH-LED35CH	30	17	Blue: Mercury vapor	Cobrahead	1	Wood	Good	4-8 Ft	Average	NEW pole installed
North Walnut Street	112	58396	HPS70CH-LED25CH	25	7	Yellow: Sodium vapor lamp	Cobrahead	1	Wood	Average	4-8 Ft	Average	NEW pole installed
Spring Street			HPS70CH-LED25CH	25	7	Yellow: Sodium vapor lamp	Cobrahead	1	Wood	Average	4-8 Ft	Average	NEW pole installed
North Walnut Street		58393	MV175CH-LED35CH	25	17	Blue: Mercury vapor	Cobrahead	1	Wood	Average	4-8 Ft	Average	NEW pole installed
Main Street	387		HPS250CH-LED145CH	30	25	Yellow: Sodium vapor lamp	Cobrahead	1	Metal	Good	8-12 FT	Good	NEW pole installed
Main Street		74280	HPS250CH-LED145CH	30	25	Yellow: Sodium vapor lamp	Cobrahead	1	Metal	Good	8-12 FT	Good	NEW pole installed
Falconer Street	17	30429	MV175CH-LED35CH	30	17	Blue: Mercury vapor	Cobrahead	1	Wood	Average	4-8 Ft	Average	NEW pole installed
Henderson Street		34417	HPS70CH-LED25CH	30	7	Yellow: Sodium vapor lamp	Cobrahead	1	Wood	Average	4-8 Ft	Average	NEW pole installed
Wodell Street	1	132525	MV175CH-LED35CH	30	17	Blue: Mercury vapor	Other	1	Wood	Average	4-8 Ft	Average	Dusk to dawn, replace with cobra
Cannon Street		57492	HPS150CH-LED72CH	40	15	Yellow: Sodium vapor lamp	Cobrahead	1	Wood	Good	4-8 Ft	Average	Dusk to dawn, replace with cobra
Wodell Street	9	134647	MV175CH-LED35CH	30	17	Blue: Mercury vapor	Cobrahead	1	Wood	Average	4-8 Ft	Average	Dusk to dawn, replace with cobra
Main Street			HPS150CH-LED72CH	30	15	Yellow: Sodium vapor lamp	Cobrahead	1	Wood	Average	4-8 Ft	Average	Dusk to dawn, replace with cobra
Cannon Street		57493	HPS150CH-LED72CH	40	15	Yellow: Sodium vapor lamp	Cobrahead	1	Wood	Good	8-12 FT	Average	Dusk to dawn, replace with cobra
Rende Drive	12	74276	MV100CH-LED25CH	30	10	Blue: Mercury vapor	Cobrahead	1	Wood	Average	4-8 Ft	Average	Dusk to dawn, replace with cobra
Heaney Drive	4	77699	MV100CH-LED25CH	30	10	Blue: Mercury vapor	Cobrahead	1	Wood	Average	4-8 Ft	Average	Dusk to dawn, replace with cobra
West Main Street	23	133799	HPS250CH-LED145CH	25	25	Yellow: Sodium vapor lamp	Cobrahead	1	Wood	Average	4-8 Ft	Average	Dusk to dawn, replace with cobra
Heaney Drive	14	83863	HPS70CH-LED25CH	30	7	Yellow: Sodium vapor lamp	Cobrahead	1	Wood	Average	4-8 Ft	Average	Dusk to dawn, replace with cobra
West Main Street		125679	MV175CH-LED35CH	25	17	Blue: Mercury vapor	Cobrahead	1	Wood	Average	4-8 Ft	Average	Dusk to dawn, replace with cobra
Heaney Drive	18	83864	HPS70CH-LED25CH	30	7	Yellow: Sodium vapor lamp	Cobrahead	1	Wood	Average	4-8 Ft	Average	Dusk to dawn, replace with cobra
Heaney Drive		83866	HPS70CH-LED25CH	30	7	Yellow: Sodium vapor lamp	Cobrahead	1	Wood	Average	4-8 Ft	Average	Dusk to dawn, replace with cobra
Branch Street		78126	HPS70CH-LED25CH	25	7	Yellow: Sodium vapor lamp	Cobrahead	1	Wood	Good	4-8 Ft	Average	Dusk to dawn, replace with cobra
Bank Street		125645	HPS70CH-LED25CH	25	7	Yellow: Sodium vapor lamp	Cobrahead	1	Wood	Good	4-8 Ft	Average	Dusk to dawn, replace with cobra
Phillips Street	69	74273	HPS70CH-LED25CH	30	7	Yellow: Sodium vapor lamp	Cobrahead	1	Wood	Average	4-8 Ft	Average	Dusk to dawn, replace with cobra
Bank Street		125640	HPS70CH-LED25CH	25	7	Yellow: Sodium vapor lamp	Cobrahead	1	Wood	Good	4-8 Ft	Average	Dusk to dawn, replace with cobra
Schofield Place	3	81554	HPS70CH-LED25CH	30	7	Yellow: Sodium vapor lamp	Cobrahead	1	Wood	Average	4-8 Ft	Average	Dusk to dawn, replace with cobra
Schofield Place	7	81555	MV175CH-LED35CH	30	17	Blue: Mercury vapor	Cobrahead	1	Wood	Average	4-8 Ft	Average	Dusk to dawn, replace with cobra
Tompkins Terrace		125639	HPS150CH-LED72CH	25	15	Yellow: Sodium vapor lamp	Cobrahead	1	Wood	Average	4-8 Ft	Average	Dusk to dawn, replace with cobra
Henry Street			HPS250CH-LED145CH	30	25	Yellow: Sodium vapor lamp	Cobrahead	1	Metal	Good	8-12 FT	Good	Dusk to dawn, replace with cobra
Teller Avenue			HPS250CH-LED145CH	30	25	Yellow: Sodium vapor lamp	Cobrahead	1	Metal	Average	8-12 FT	Good	Dusk to dawn, replace with cobra
Veterans Place			HPS250CH-LED145CH	30	25	Yellow: Sodium vapor lamp	Cobrahead	1	Metal	Good	8-12 FT	Good	Dusk to dawn, replace with cobra
Henry Street			HPS250CH-LED145CH	30	25	Yellow: Sodium vapor lamp	Cobrahead	1	Metal	Average	8-12 FT	Good	Dusk to dawn, replace with cobra
Veterans Place			HPS250CH-LED145CH	30	25	Yellow: Sodium vapor lamp	Cobrahead	1	Metal	Good	8-12 FT	Good	Dusk to dawn, replace with cobra
Pearse Place		79077	HPS70CH-LED25CH	30	7	Yellow: Sodium vapor lamp	Cobrahead	1	Wood	Average	4-8 Ft	Average	Dusk to dawn, replace with cobra
Pearse Place		79029	HPS70CH-LED25CH	30	7	Yellow: Sodium vapor lamp	Cobrahead	1	Wood	Average	4-8 Ft	Average	Dusk to dawn, replace with cobra
Rende Drive	3	74274	HPS70CH-LED25CH	30	7	Yellow: Sodium vapor lamp	Cobrahead	1	Wood	Average	4-8 Ft	Average	Dusk to dawn, replace with cobra
Asylum Road		134825	HPS70CH-LED25CH	25	7	Yellow: Sodium vapor lamp	Cobrahead	1	Wood	Average	8-12 FT	Average	Dusk to dawn, replace with cobra
Buchanan Street	16	63421	HPS70CH-LED25CH	25	7	Yellow: Sodium vapor lamp	Cobrahead	1	Wood	Good	4-8 Ft	Average	Dusk to dawn, replace with cobra
Buchanan Street		63419	MV175CH-LED35CH	25	17	Blue: Mercury vapor	Cobrahead	1	Wood	Average	4-8 Ft	Average	Dusk to dawn, replace with cobra
Buchanan Street		63418	HPS70CH-LED25CH	25	7	Yellow: Sodium vapor lamp	Cobrahead	1	Wood	Average	4-8 Ft	Average	Dusk to dawn, replace with cobra
Glenford Avenue	30	49622	HPS70CH-LED25CH	25	7	Yellow: Sodium vapor lamp	Cobrahead	1	Wood	Average	4-8 Ft	Average	Dusk to dawn, replace

Madison Avenue	106	134559	HPS70CH-LED25CH	30	7	Yellow: Sodium vapor lamp	Cobrahead	1	Wood	Average	4 - 8 Ft	Average	
North Elm Street		13481	HPS150CH-LED72CH	25	15	Yellow: Sodium vapor lamp	Cobrahead	1	Wood	Average	4 - 8 Ft	Average	
Prospect Street		13458	HPS70CH-LED25CH	30	7	Yellow: Sodium vapor lamp	Cobrahead	1	Wood	Average	4 - 8 Ft	Average	
North Elm Street	70	63221	MV175CH-LED35CH	25	17	Blue: Mercury vapor	Cobrahead	1	Wood	Average	4 - 8 Ft	Average	Ns
Prospect Street	57	66257	HPS70CH-LED25CH	30	7	Yellow: Sodium vapor lamp	Cobrahead	1	Wood	Average	4 - 8 Ft	Average	
Vail Avenue	57	134580	MV175CH-LED35CH	30	17	Blue: Mercury vapor	Cobrahead	1	Wood	Average	4 - 8 Ft	Average	
North Elm Street	60	63219	MV175CH-LED35CH	25	17	Blue: Mercury vapor	Cobrahead	1	Wood	Good	4 - 8 Ft	Average	Ns
Vail Avenue		134582	HPS70CH-LED25CH	30	7	Yellow: Sodium vapor lamp	Cobrahead	1	Wood	Average	4 - 8 Ft	Average	
Russell Avenue		134583	HPS70CH-LED25CH	30	7	Yellow: Sodium vapor lamp	Cobrahead	1	Wood	Average	4 - 8 Ft	Average	
North Elm Street		63218	HPS70CH-LED25CH	25	7	Yellow: Sodium vapor lamp	Cobrahead	1	Wood	Good	4 - 8 Ft	Average	
Russell Avenue		40944	MV175CH-LED35CH	30	17	Blue: Mercury vapor	Cobrahead	1	Wood	Average	4 - 8 Ft	Average	
North Elm Street		63217	HPS70CH-LED25CH	25	7	Yellow: Sodium vapor lamp	Cobrahead	1	Wood	Good	4 - 8 Ft	Average	
Vail Avenue	28	26186	HPS70CH-LED25CH	30	7	Yellow: Sodium vapor lamp	Cobrahead	1	Wood	Good	4 - 8 Ft	Average	
North Elm Street		134564	HPS70CH-LED25CH	25	7	Yellow: Sodium vapor lamp	Cobrahead	1	Wood	Good	4 - 8 Ft	Average	
Schenck Avenue	17	56439	MV175CH-LED35CH	30	17	Blue: Mercury vapor	Cobrahead	1	Wood	Good	4 - 8 Ft	Average	No sticker
Vail Avenue	9	72235	MV175CH-LED35CH	30	17	Blue: Mercury vapor	Cobrahead	1	Wood	Average	4 - 8 Ft	Average	
Verplanck Avenue		75860	MV175CH-LED35CH	25	17	Blue: Mercury vapor	Cobrahead	1	Wood	Average	4 - 8 Ft	Average	Ns
Phillips Street		72236	HPS70CH-LED25CH	25	7	Yellow: Sodium vapor lamp	Cobrahead	1	Wood	Average	4 - 8 Ft	Average	
Phillips Street	16	72237	HPS150CH-LED72CH	30	15	Yellow: Sodium vapor lamp	Cobrahead	1	Wood	Average	4 - 8 Ft	Average	
Verplanck Avenue		65374	HPS250CH-LED145CH	25	25	Yellow: Sodium vapor lamp	Cobrahead	1	Wood	Average	4 - 8 Ft	Average	
Phillips Street	12	72238	MV175CH-LED35CH	30	17	Blue: Mercury vapor	Cobrahead	1	Wood	Average	4 - 8 Ft	Average	
Herbert Street	2		HPS150CH-LED72CH	30	15	Yellow: Sodium vapor lamp	Cobrahead	1	Wood	Poor	4 - 8 Ft	Poor	NEW pole installed \ fixture hasnt been relco
Union Street	56	72239	MV175CH-LED35CH	30	17	Blue: Mercury vapor	Cobrahead	1	Wood	Average	4 - 8 Ft	Average	
Willow Street	39	24904	HPS70CH-LED25CH	25	7	Yellow: Sodium vapor lamp	Cobrahead	1	Wood	Average	4 - 8 Ft	Average	
Prospect Street		84130	HPS150CH-LED72CH	25	15	Yellow: Sodium vapor lamp	Cobrahead	1	Wood	Average	4 - 8 Ft	Average	
East Willow Street	14	65371	HPS70CH-LED25CH	25	7	Yellow: Sodium vapor lamp	Cobrahead	1	Wood	Good	8 - 12 Ft	Average	
Prospect Street	40	40948	HPS70CH-LED25CH	30	7	Yellow: Sodium vapor lamp	Cobrahead	1	Wood	Good	4 - 8 Ft	Average	
Prospect Street	36	134557	MV175CH-LED35CH	30	17	Blue: Mercury vapor	Cobrahead	1	Wood	Good	4 - 8 Ft	Average	
1st Street	17	134568	HPS70CH-LED25CH	30	7	Yellow: Sodium vapor lamp	Cobrahead	1	Wood	Average	4 - 8 Ft	Average	
Blackburn Avenue		83529	HPS150CH-LED72CH	30	15	Yellow: Sodium vapor lamp	Cobrahead	1	Wood	Good	4 - 8 Ft	Average	
Russell Avenue	23	141964	HPS70CH-LED25CH	30	7	Yellow: Sodium vapor lamp	Cobrahead	1	Wood	Average	4 - 8 Ft	Average	
Russell Avenue	69	141966	HPS70CH-LED25CH	30	7	Yellow: Sodium vapor lamp	Cobrahead	1	Wood	Average	4 - 8 Ft	Average	
Blackburn Avenue		83527	HPS150CH-LED72CH	35	15	Yellow: Sodium vapor lamp	Cobrahead	1	Wood	Average	4 - 8 Ft	Average	
Oak Street		64673	MV175CH-LED35CH	25	17	Blue: Mercury vapor	Cobrahead	1	Wood	Good	4 - 8 Ft	Good	Ns
Willow Street		42560	MV175CH-LED35CH	25	17	Blue: Mercury vapor	Cobrahead	1	Wood	Good	4 - 8 Ft	Good	Ns
Willow Street		71892	HPS150CH-LED72CH	25	15	Yellow: Sodium vapor lamp	Cobrahead	1	Wood	Good	4 - 8 Ft	Average	
Willow Street		27267	MV175CH-LED35CH	30	17	Blue: Mercury vapor	Cobrahead	1	Wood	Good	4 - 8 Ft	Average	Ns
Willow Street		27266	HPS70CH-LED25CH	25	7	Yellow: Sodium vapor lamp	Cobrahead	1	Wood	Average	4 - 8 Ft	Average	
Green Street	30	28489	HPS250CH-LED145CH	30	25	Yellow: Sodium vapor lamp	Cobrahead	2	Wood	Good	4 - 8 Ft	Average	25 facing park street side appears smaller but
Digger Phelps Court			HPS250CH-LED145CH	25	25	Yellow: Sodium vapor lamp	Cobrahead	1	Wood	Average	4 - 8 Ft	Average	
Larch Street	14	134298	HPS70CH-LED25CH	40	7	Yellow: Sodium vapor lamp	Cobrahead	1	Wood	Good	4 - 8 Ft	Poor	
Green Street	1	13455	HPS70CH-LED25CH	30	7	Yellow: Sodium vapor lamp	Cobrahead	1	Wood	Average	4 - 8 Ft	Average	
Judson Street		134572	HPS70CH-LED25CH	30	7	Yellow: Sodium vapor lamp	Cobrahead	1	Wood	Average	4 - 8 Ft	Average	
Church Street	13	134439	HPS70CH-LED25CH	25	7	Yellow: Sodium vapor lamp	Cobrahead	1	Wood	Average	4 - 8 Ft	Average	
Judson Street		134571	MV175CH-LED35CH	40	17	Blue: Mercury vapor	Cobrahead	1	Wood	Average	4 - 8 Ft	Average	
Judson Street	38	134567	HPS70CH-LED25CH	30	7	Yellow: Sodium vapor lamp	Cobrahead	1	Wood	Average	4 - 8 Ft	Average	
Judson Street	46	28892	HPS70CH-LED25CH	40	7	Yellow: Sodium vapor lamp	Cobrahead	1	Wood	Average	4 - 8 Ft	Average	
Union Street		65375	HPS70CH-LED25CH	30	7	Yellow: Sodium vapor lamp	Cobrahead	1	Wood	Average	4 - 8 Ft	Average	
Duncan Street		71219	HPS70CH-LED25CH	30	7	Yellow: Sodium vapor lamp	Cobrahead	1	Wood	Good	4 - 8 Ft	Average	
North Elm Street		27255	MV175CH-LED35CH	25	17	Blue: Mercury vapor	Cobrahead	1	Wood	Average	4 - 8 Ft	Average	Ns
Oak Street		38232	MV175CH-LED35CH	25	17	Blue: Mercury vapor	Cobrahead	1	Wood	Average	4 - 8 Ft	Average	Ns
Robinson Street		134553	MV175CH-LED35CH	30	17	Blue: Mercury vapor	Cobrahead	1	Wood	Average	4 - 8 Ft	Average	
Oak Street		64674	MV175CH-LED35CH	25	17	Blue: Mercury vapor	Cobrahead	1	Wood	Average	4 - 8 Ft	Average	
Goodrich Street	15	134550	MV175CH-LED35CH	25	17	Blue: Mercury vapor	Cobrahead	1	Wood	Average	4 - 8 Ft	Average	
Goodrich Street		134549	HPS70CH-LED25CH	25	7	Yellow: Sodium vapor lamp	Cobrahead	1	Wood	Average	4 - 8 Ft	Average	
North Elm Street	40	27259	HPS70CH-LED25CH	30	7	Yellow: Sodium vapor lamp	Cobrahead	1	Wood	Average	4 - 8 Ft	Average	
Howland Avenue	100	102387	HPS70CH-LED25CH	30	7	Yellow: Sodium vapor lamp	Cobrahead	1	Wood	Average	4 - 8 Ft	Average	
Willow Street		851760	HPS70CH-LED25CH	25	7	Yellow: Sodium vapor lamp	Cobrahead	1	Wood	Average	4 - 8 Ft	Average	
Union Street	73	40941	HPS70CH-LED25CH	25	7	Yellow: Sodium vapor lamp	Cobrahead	1	Wood	Average	4 - 8 Ft	Average	
Orchard Place			HPS70CH-LED25CH	25	7	Yellow: Sodium vapor lamp	Cobrahead	1	Wood	Average	8 - 12 Ft	Average	
Union Street		33307	HPS70CH-LED25CH	30	7	Yellow: Sodium vapor lamp	Cobrahead	2	Wood	Good	4 - 8 Ft	Average	
Orchard Place	70	28860	HPS70CH-LED25CH	25	7	Yellow: Sodium vapor lamp	Cobrahead	1	Wood	Average	4 - 8 Ft	Average	
East Willow Street	6	134447	HPS70CH-LED25CH	25	7	Yellow: Sodium vapor lamp	Cobrahead	1	Wood	Average	4 - 8 Ft	Average	
West Willow Street		58745	HPS70CH-LED25CH	30	7	Yellow: Sodium vapor lamp	Cobrahead	1	Wood	Average	4 - 8 Ft	Average	
1st Street		134569	MV175CH-LED35CH	30	17	Blue: Mercury vapor	Cobrahead	1	Wood	Average	4 - 8 Ft	Average	
Oak Street	5	26250	MV175CH-LED35CH	25	17	Blue: Mercury vapor	Cobrahead	1	Wood	Average	4 - 8 Ft	Good	
Blackburn Avenue		83525	HPS70CH-LED25CH	40	7	Yellow: Sodium vapor lamp	Cobrahead	1	Wood	Good	4 - 8 Ft	Average	
Willow Street		134441	HPS70CH-LED25CH	25	7	Yellow: Sodium vapor lamp	Cobrahead	1	Wood	Good	4 - 8 Ft	Average	Ns
Church Street		67300	HPS70CH-LED25CH	25	7	Yellow: Sodium vapor lamp	Cobrahead	1	Wood	Good	4 - 8 Ft	Average	
Franklin Avenue	4	24905	MV175CH-LED35CH	30	17	Blue: Mercury vapor	Cobrahead	1	Wood	Average	4 - 8 Ft	Average	No sticker
Green Street		102313	HPS70CH-LED25CH	25	7	Yellow: Sodium vapor lamp	Cobrahead	1	Wood	Average	4 - 8 Ft	Average	
Green Street	14	134564	HPS70CH-LED25CH	25	7	Yellow: Sodium vapor lamp	Cobrahead	1	Wood	Average	4 - 8 Ft	Average	
Digger Phelps Court	11	59920	HPS250CH-LED145CH	25	25	Yellow: Sodium vapor lamp	Cobrahead	1	Wood	Average	4 - 8 Ft	Average	
Green Street	10	51305	HPS70CH-LED25CH	25	7	Yellow: Sodium vapor lamp	Cobrahead	1	Wood	Average	4 - 8 Ft	Average	
Church Street		26518	HPS70CH-LED25CH	25	7	Yellow: Sodium vapor lamp	Cobrahead	1	Wood	Average	4 - 8 Ft	Average	
Digger Phelps Court	9	26517	HPS150CH-LED72CH	25	15	Yellow: Sodium vapor lamp	Cobrahead	1	Wood	Average	4 - 8 Ft	Average	
Franklin Avenue			HPS70CH-LED25CH	30	7	Yellow: Sodium vapor lamp	Cobrahead	1	Wood	Average	4 - 8 Ft	Average	
Robinson Street		83515	HPS70CH-LED25CH	30	7	Yellow: Sodium vapor lamp	Cobrahead	1	Wood	Average	4 - 8 Ft	Average	
North Elm Street		71890	MV175CH-LED35CH	25	17	Blue: Mercury vapor	Cobrahead	1	Wood	Average	4 - 8 Ft	Average	Ns
North Elm Street		56438	HPS150CH-LED72CH	25	15	Yellow: Sodium vapor lamp	Cobrahead	1	Wood	Average	4 - 8 Ft	Average	
Church Street		30335	HPS70CH-LED25CH	25	7	Yellow: Sodium vapor lamp	Cobrahead	1	Wood	Good	4 - 8 Ft	Average	
Main Street	925	67465	HPS70CH-LED25CH	20	7	Yellow: Sodium vapor lamp	Cobrahead	1	Wood	Average	4 - 8 Ft	Average	
Duncan Street	11	31728	HPS70CH-LED25CH	30	7	Yellow: Sodium vapor lamp	Cobrahead	1	Wood	Average	4 - 8 Ft	Average	
North Elm Street	24	27256	HPS70CH-LED25CH	25	7	Yellow: Sodium vapor lamp	Cobrahead	1	Wood	Average	4 - 8 Ft	Average	
Duncan Street	9	134565	HPS150CH-LED72CH	30	15	Yellow: Sodium vapor lamp	Cobrahead	1	Wood	Average	4 - 8 Ft	Average	
Duncan Street	5	134566	MV175CH-LED35CH	30	17	Blue: Mercury vapor	Cobrahead	1	Wood	Average	4 - 8 Ft	Average	
Oak Street		64675	HPS70CH-LED25CH	30	7	Yellow: Sodium vapor lamp	Cobrahead	1	Wood	Good	4 - 8 Ft	Average	
Goodrich Street	71	847	HPS70CH-LED25CH	30	7	Yellow: Sodium vapor lamp	Cobrahead	1	Wood	Average	4 - 8 Ft	Average	
Goodrich Street	3	134551	HPS70CH-LED25CH	25	7	Yellow: Sodium vapor lamp	Cobrahead	1	Wood	Average	4 - 8 Ft	Average	
Goodrich Street		134560	HPS70CH-LED25CH	30	7	Yellow: Sodium vapor lamp	Cobrahead	1	Wood	Average	4 - 8 Ft	Average	
Willow Street			HPS70CH-LED25CH	30	7	Yellow: Sodium vapor lamp	Cobrahead	1	Wood	Average	4 - 8 Ft	Average	
Verplanck Avenue		32666	HPS70CH-LED25CH	25	7	Yellow: Sodium vapor lamp	Cobrahead	1	Wood	Average	4 - 8 Ft	Average	
Howland Avenue	77	102330	MV175CH-LED35CH	30	17	Blue: Mercury vapor	Cobrahead	1	Wood	Average	4 - 8 Ft	Average	
Verplanck Avenue		23258	MV175CH-LED35CH	30	17	Blue: Mercury vapor	Cobrahead	1	Wood	Average	4 - 8 Ft	Average	Ns
Howland Avenue	57	76255	MV175CH-LED35CH	30	17	Blue: Mercury vapor	Cobrahead	1	Wood	Average	4 - 8 Ft	Average	
Howland Avenue		p40942	HPS70CH-LED25CH	25	7	Yellow: Sodium vapor lamp	Cobrahead	1	Wood	Average	4 - 8 Ft	Average	
North Walnut Street	31	65890	HPS250CH-LED145CH	25	25	Yellow: Sodium vapor lamp	Cobrahead	1	Wood	Average	4 - 8 Ft	Average	
Oak Street		44383	MV175CH-LED35CH	30	17	Blue: Mercury vapor	Cobrahead	1	Wood	Average	4 - 8 Ft	Average	Ns
Wilkes Street	26	134816	HPS70CH-LED25CH	35	7	Yellow: Sodium vapor lamp	Cobrahead	1	Wood	Average	4 - 8 Ft	Average	
North Walnut Street	26	190430	HPS70CH-LED25CH	25	7	Yellow: Sodium vapor lamp	Cobrahead	1	Wood	Average	4 - 8 Ft	Average	
North Walnut Street		40241	HPS70CH-LED25CH	30	7	Yellow: Sodium vapor lamp	Cobrahead	1	Wood	Average	4 - 8 Ft	Average	
Alice Street	44	134575	HPS70CH-LED25CH	25	7	Yellow: Sodium vapor lamp	Cobrahead	1	Wood	Average	4 - 8 Ft	Average	
Wilkes Street	54	134817	HPS150CH-LED72CH	35	15	Yellow: Sodium vapor lamp	Cobrahead	1	Wood	Average	4 - 8 Ft	Average	
North Walnut Street		28888	HPS70CH-LED25CH	25	7	Yellow: Sodium vapor lamp	Cobrahead	1	Wood	Good	4 - 8 Ft	Average	
Alice Street	50	134576	HPS70CH-LED25CH	30	7	Yellow: Sodium vapor lamp	Cobrahead	1	Wood	Average	4 - 8 Ft	Average	
North Walnut Street			HPS150CH-LED72CH	25	15	Yellow: Sodium vapor lamp	Cobrahead	1	Wood	Average	4 - 8 Ft	Average	
Alice Street	18	69865	HPS70CH-LED25CH	25	7	Yellow: Sodium vapor lamp	Cobrahead	1	Wood	Average	4 - 8 Ft	Average	
Alice Street		134573	HPS70CH-LED25CH	25	7	Yellow: Sodium vapor lamp	Cobrahead	1	Wood	Average	4 - 8 Ft	Average	
Wilkes Street	54	134819	HPS150CH-LED72CH	35	15	Yellow: Sodium vapor lamp	Cobrahead	1	Wood	Average	4 - 8 Ft	Average	
Alice Street		134577	MV175CH-LED35CH	30	17	Blue: Mercury vapor	Cobrahead	1	Wood	Average	4 - 8 Ft	Average	
Robinson Street	36	134556	HPS150CH-LED72CH	30	15	Yellow: Sodium vapor lamp	Cobrahead	1	Wood	Average	4 - 8 Ft	Average	



Maple Street	42	134301	HPS70CH-LED25CH	30	7	Yellow: Sodium vapor lamp	Cobrahead	1	Wood	Good	4 - 8 Ft	Average	
North Chestnut Street	14		HPS250CH-LED145CH	25	25	Yellow: Sodium vapor lamp	Cobrahead	1	Metal	Good	4 - 8 Ft	Average	
North Chestnut Street	138	40936	HPS70CH-LED25CH	30	7	Yellow: Sodium vapor lamp	Cobrahead	1	Wood	Good	4 - 8 Ft	Average	
Maple Street	64	65886	HPS150CH-LED72CH	20	15	Yellow: Sodium vapor lamp	Cobrahead	1	Wood	Good	0 - 4 Ft	Average	
North Chestnut Street			HPS150CH-LED72CH	25	15	Yellow: Sodium vapor lamp	Cobrahead	1	Metal	Good	4 - 8 Ft	Average	Weird fixture attached
Mountain Lane		134486	MV175CH-LED35CH	30	17	Blue: Mercury vapor	Cobrahead	1	Wood	Average	4 - 8 Ft	Average	
Church Street			HPS150CH-LED72CH	25	15	Yellow: Sodium vapor lamp	Cobrahead	1	Metal	Good	4 - 8 Ft	Average	
Mountain Lane		134489	HPS70CH-LED25CH	30	7	Yellow: Sodium vapor lamp	Cobrahead	1	Wood	Average	4 - 8 Ft	Average	
Eliza Street			HPS70CH-LED25CH	25	7	Yellow: Sodium vapor lamp	Cobrahead	1	Metal	Average	4 - 8 Ft	Average	
Maple Street			HPS70CH-LED25CH	30	7	Yellow: Sodium vapor lamp	Cobrahead	1					
Mountain Lane	93	134492	MV175CH-LED35CH	30	17	Blue: Mercury vapor	Cobrahead	1	Wood	Average	4 - 8 Ft	Average	
Church Street			HPS250CH-LED145CH	25	25	Yellow: Sodium vapor lamp	Cobrahead	1	Metal	Good	4 - 8 Ft	Good	
Church Street			HPS250CH-LED145CH	25	25	Yellow: Sodium vapor lamp	Cobrahead	1	Metal	Good	4 - 8 Ft	Good	
North Chestnut Street			HPS250CH-LED145CH	25	25	Yellow: Sodium vapor lamp	Cobrahead	1	Metal	Good	4 - 8 Ft	Good	
Mountain Lane	82	134494	HPS70CH-LED25CH	30	7	Yellow: Sodium vapor lamp	Cobrahead	1	Wood	Average	4 - 8 Ft	Average	
North Chestnut Street		35245	MV175CH-LED35CH	25	17	Blue: Mercury vapor	Cobrahead	1	Wood	Average	4 - 8 Ft	Average	Ns
North Chestnut Street	46	39252	MV175CH-LED35CH	25	17	Blue: Mercury vapor	Cobrahead	1	Wood	Good	4 - 8 Ft	Good	
Mountain Lane	42	77644	MV175CH-LED35CH	30	17	Blue: Mercury vapor	Cobrahead	1	Wood	Average	4 - 8 Ft	Average	
Oak Street	49	134329	MV175CH-LED35CH	25	17	Blue: Mercury vapor	Cobrahead	1	Wood	Good	4 - 8 Ft	Good	
Oak Street	75	134328	HPS70CH-LED25CH	25	7	Yellow: Sodium vapor lamp	Cobrahead	1	Wood	Average	4 - 8 Ft	Average	
Lincoln Avenue	23	134305	MV175CH-LED35CH	20	17	Blue: Mercury vapor	Cobrahead	1	Wood	Average	4 - 8 Ft	Poor	No sticker
Mountain Lane	31	77646	HPS70CH-LED25CH	30	7	Yellow: Sodium vapor lamp	Cobrahead	1	Wood	Average	4 - 8 Ft	Average	
Oak Street		134331	HPS70CH-LED25CH	25	7	Yellow: Sodium vapor lamp	Cobrahead	1	Wood	Good	4 - 8 Ft	Average	
East Main Street		77647	MV175CH-LED35CH	30	17	Blue: Mercury vapor	Cobrahead	1	Wood	Average	4 - 8 Ft	Average	
North Chestnut Street	56	134300	HPS70CH-LED25CH	25	7	Yellow: Sodium vapor lamp	Cobrahead	1	Wood	Good	4 - 8 Ft	Average	
North Chestnut Street	68	28923	MV175CH-LED35CH	25	17	Blue: Mercury vapor	Cobrahead	1	Wood	Average	4 - 8 Ft	Average	
East Main Street			HPS70CH-LED25CH	30	7	Yellow: Sodium vapor lamp	Cobrahead	1	Wood	Average	4 - 8 Ft	Average	
North Chestnut Street	134	134321	HPS150CH-LED72CH	25	15	Yellow: Sodium vapor lamp	Cobrahead	1	Wood	Good	4 - 8 Ft	Average	
Pocket Road	6	82872	HPS70CH-LED25CH	25	7	Yellow: Sodium vapor lamp	Cobrahead	1	Wood	Average	4 - 8 Ft	Average	
East Main Street	318	134498	MV175CH-LED35CH	30	17	Blue: Mercury vapor	Cobrahead	1	Wood	Average	4 - 8 Ft	Average	
Lincoln Avenue		134307	HPS70CH-LED25CH	20	7	Yellow: Sodium vapor lamp	Cobrahead	1	Wood	Average	4 - 8 Ft	Average	
Verplank Avenue		134315	HPS250CH-LED145CH	25	25	Yellow: Sodium vapor lamp	Cobrahead	1	Wood	Average	4 - 8 Ft	Average	
Laurel Street	14	134500	HPS70CH-LED25CH	30	7	Yellow: Sodium vapor lamp	Cobrahead	1	Wood	Average	4 - 8 Ft	Average	
Lincoln Avenue	42	58353	MV175CH-LED35CH	25	17	Blue: Mercury vapor	Cobrahead	1	Wood	Average	4 - 8 Ft	Average	No sticker
Van Kleeck Avenue		164157	HPS70CH-LED25CH	30	7	Yellow: Sodium vapor lamp	Cobrahead	1	Wood	Average	4 - 8 Ft	Average	
Van Kleeck Avenue	11	69892	HPS70CH-LED25CH	30	7	Yellow: Sodium vapor lamp	Cobrahead	1	Wood	Average	4 - 8 Ft	Average	
Eliza Street		35244	HPS70CH-LED25CH	25	7	Yellow: Sodium vapor lamp	Cobrahead	1	Wood	Good	4 - 8 Ft	Average	
Van Kleeck Avenue	32	69893	HPS70CH-LED25CH	25	7	Yellow: Sodium vapor lamp	Cobrahead	1	Wood	Average	4 - 8 Ft	Average	
Eliza Street	41	24876	HPS70CH-LED25CH	25	7	Yellow: Sodium vapor lamp	Cobrahead	1	Wood	Good	4 - 8 Ft	Average	
Lincoln Avenue	46	58354	HPS70CH-LED25CH	20	7	Yellow: Sodium vapor lamp	Cobrahead	1	Wood	Average	4 - 8 Ft	Poor	Need tree Service
Van Kleeck Avenue	4	2749	HPS70CH-LED25CH	30	7	Yellow: Sodium vapor lamp	Cobrahead	1	Wood	Average	4 - 8 Ft	Average	Tag says customer property
Kent Street		134308	HPS70CH-LED25CH	25	7	Yellow: Sodium vapor lamp	Cobrahead	1	Wood	Good	4 - 8 Ft	Average	
Van Kleeck Avenue	35	102228	MV175CH-LED35CH	30	17	Blue: Mercury vapor	Cobrahead	1	Wood	Average	4 - 8 Ft	Average	
Kent Street			MV175CH-LED35CH	30	17	Blue: Mercury vapor	Cobrahead	1	Wood	Average	4 - 8 Ft	Average	
Lincoln Avenue		62293	HPS150CH-LED72CH	20	15	Yellow: Sodium vapor lamp	Cobrahead	1	Wood	Average	4 - 8 Ft	Poor	
Depuyter Avenue	33	102232	HPS70CH-LED25CH	30	7	Yellow: Sodium vapor lamp	Cobrahead	1	Wood	Average	4 - 8 Ft	Average	
Caroline Street	19	69895	HPS150CH-LED72CH	30	15	Yellow: Sodium vapor lamp	Cobrahead	1	Wood	Good	8 - 12 Ft	Average	
Driveway		23252	HPS70CH-LED25CH	25	7	Yellow: Sodium vapor lamp	Cobrahead	1	Wood	Good	8 - 12 Ft	Average	
East Main Street		66602	HPS150CH-LED72CH	30	15	Yellow: Sodium vapor lamp	Cobrahead	1	Wood	Good	8 - 12 Ft	Average	
William Street	15	30319	HPS70CH-LED25CH	25	7	Yellow: Sodium vapor lamp	Cobrahead	1	Wood	Average	4 - 8 Ft	Average	
East Main Street		3062	HPS150CH-LED72CH	30	15	Yellow: Sodium vapor lamp	Cobrahead	1	Wood	Good	4 - 8 Ft	Average	
Caroline Street	19	69895	HPS70CH-LED25CH	30	7	Yellow: Sodium vapor lamp	Cobrahead	1	Wood	Average	4 - 8 Ft	Average	
Annan Street	15	134502	MV175CH-LED35CH	30	17	Blue: Mercury vapor	Cobrahead	1	Wood	Average	4 - 8 Ft	Average	
Annan Street		134501	HPS150CH-LED72CH	30	15	Yellow: Sodium vapor lamp	Cobrahead	1	Wood	Average	4 - 8 Ft	Average	
Main Street	544	172200	HPS250CH-LED145CH	20	25	Yellow: Sodium vapor lamp	Cobrahead	1	Wood	Poor	4 - 8 Ft	Average	No sticker / new pole ha been installed
Falconer Street	39	p71269	MV175CH-LED35CH	30	17	Blue: Mercury vapor	Cobrahead	1	Wood	Good	4 - 8 Ft	Average	
East Main Street			MV175CH-LED35CH	30	17	Blue: Mercury vapor	Cobrahead	1	Wood	Good	4 - 8 Ft	Average	
Odell Street	7	134508	HPS70CH-LED25CH	30	7	Yellow: Sodium vapor lamp	Cobrahead	1	Wood	Good	4 - 8 Ft	Average	
East Main Street	185	185799	MV175CH-LED35CH	30	17	Blue: Mercury vapor	Cobrahead	1	Wood	Good	4 - 8 Ft	Average	175w 120v on tag
East Main Street	162	134509	MV175CH-LED35CH	30	17	Blue: Mercury vapor	Cobrahead	1	Wood	Good	4 - 8 Ft	Average	175w 120v on tag
Main Street			HPS250CH-LED145CH	30	25	Yellow: Sodium vapor lamp	Cobrahead	1	Metal	Good	12 - 16 Ft	Average	
North Walnut Street		58395	HPS70CH-LED25CH	25	7	Yellow: Sodium vapor lamp	Cobrahead	1	Wood	Average	4 - 8 Ft	Average	Ns
Washington Avenue		134511	HPS70CH-LED25CH	25	7	Yellow: Sodium vapor lamp	Cobrahead	1	Wood	Average	4 - 8 Ft	Average	
North Walnut Street		58394	HPS70CH-LED25CH	25	7	Yellow: Sodium vapor lamp	Cobrahead	1	Wood	Average	4 - 8 Ft	Average	
Main Street	395		HPS150CH-LED72CH	30	15	Yellow: Sodium vapor lamp	Cobrahead	1	Metal	Good	8 - 12 Ft	Average	
Washington Avenue	6	34408	MV175CH-LED35CH	30	17	Blue: Mercury vapor	Cobrahead	1	Wood	Average	4 - 8 Ft	Average	
Washington Avenue	20	27749	HPS70CH-LED25CH	30	7	Yellow: Sodium vapor lamp	Cobrahead	1	Wood	Good	4 - 8 Ft	Average	
Washington Avenue	28	34410	MV175CH-LED35CH	30	17	Blue: Mercury vapor	Cobrahead	1	Wood	Average	8 - 12 Ft	Average	
Carmon Street		36474	HPS70CH-LED25CH	30	7	Yellow: Sodium vapor lamp	Cobrahead	1	Wood	Average	4 - 8 Ft	Average	
Boyce Street	35	134642	MV175CH-LED35CH	30	17	Blue: Mercury vapor	Cobrahead	1	Wood	Average	4 - 8 Ft	Average	
Main Street			HPS150CH-LED72CH	30	15	Yellow: Sodium vapor lamp	Cobrahead	1	Metal	Good	8 - 12 Ft	Good	
Main Street			HPS250CH-LED145CH	30	25	Yellow: Sodium vapor lamp	Cobrahead	1	Metal	Good	8 - 12 Ft	Good	
Henderson Street	17	134644	MV175CH-LED35CH	30	17	Blue: Mercury vapor	Cobrahead	1	Wood	Average	4 - 8 Ft	Average	
Washington Avenue	58	34415	HPS70CH-LED25CH	30	7	Yellow: Sodium vapor lamp	Cobrahead	1	Wood	Average	4 - 8 Ft	Average	
Main Street			HPS150CH-LED72CH	30	15	Yellow: Sodium vapor lamp	Cobrahead	1	Wood	Average	4 - 8 Ft	Average	
Washington Avenue		34414	MV175CH-LED35CH	30	17	Blue: Mercury vapor	Cobrahead	1	Wood	Good	4 - 8 Ft	Average	
Cannon Street			HPS150CH-LED72CH	40	15	Yellow: Sodium vapor lamp	Cobrahead	1	Wood	Good	8 - 12 Ft	Average	
Main Street	341		HPS150CH-LED72CH	30	15	Yellow: Sodium vapor lamp	Cobrahead	1	Metal	Good	4 - 8 Ft	Good	
Cannon Street	53	47495	HPS150CH-LED72CH	35	15	Yellow: Sodium vapor lamp	Cobrahead	1	Wood	Average	8 - 12 Ft	Average	Ns
Main Street			HPS150CH-LED72CH	30	15	Yellow: Sodium vapor lamp	Cobrahead	1	Concrete	Good	12 - 16 Ft	Good	
Main Street	333		HPS250CH-LED145CH	30	25	Yellow: Sodium vapor lamp	Cobrahead	1	Metal	Good	12 - 16 Ft	Good	
Asylum Road		79942	HPS70CH-LED25CH	30	7	Yellow: Sodium vapor lamp	Cobrahead	1	Wood	Average	8 - 12 Ft	Average	
Main Street	314		HPS250CH-LED145CH	30	25	Yellow: Sodium vapor lamp	Cobrahead	1	Concrete	Good	12 - 16 Ft	Good	
Spring Street	57	42270	HPS150CH-LED72CH	30	15	Yellow: Sodium vapor lamp	Cobrahead	1	Wood	Average	4 - 8 Ft	Average	
Asylum Road		79943	HPS70CH-LED25CH	30	7	Yellow: Sodium vapor lamp	Cobrahead	1	Wood	Good	8 - 12 Ft	Average	
North Chestnut Street			HPS150CH-LED72CH	30	15	Yellow: Sodium vapor lamp	Cobrahead	1	Metal	Good	12 - 16 Ft	Good	
Spring Street	45	27756	HPS150CH-LED72CH	30	15	Yellow: Sodium vapor lamp	Cobrahead	1	Wood	Average	4 - 8 Ft	Average	
Asylum Road		79944	HPS70CH-LED25CH	30	7	Yellow: Sodium vapor lamp	Cobrahead	1	Wood	Good	8 - 12 Ft	Average	
Spring Street	39	p42269	HPS70CH-LED25CH	30	7	Yellow: Sodium vapor lamp	Cobrahead	1	Wood	Good	4 - 8 Ft	Average	
Asylum Road		79945	HPS70CH-LED25CH	30	7	Yellow: Sodium vapor lamp	Cobrahead	1	Wood	Average	8 - 12 Ft	Average	Ns
Main Street			HPS150CH-LED72CH	30	15	Yellow: Sodium vapor lamp	Cobrahead	1	Metal	Good	8 - 12 Ft	Good	
Spring Street		40929	HPS70CH-LED25CH	30	7	Yellow: Sodium vapor lamp	Cobrahead	1	Wood	Average	4 - 8 Ft	Average	
Asylum Road		74761	HPS250CH-LED145CH	30	25	Yellow: Sodium vapor lamp	Cobrahead	1	Wood	Good	8 - 12 Ft	Average	
Main Street	324		HPS150CH-LED72CH	30	15	Yellow: Sodium vapor lamp	Cobrahead	1	Metal	Good	4 - 8 Ft	Good	
Spring Street		38233p	MV175CH-LED35CH	30	17	Blue: Mercury vapor	Cobrahead	1	Wood	Average	4 - 8 Ft	Average	
Asylum Road			HPS250CH-LED145CH	30	25	Yellow: Sodium vapor lamp	Cobrahead	1	Metal	Good	8 - 12 Ft	Average	
Liberty Street		80395	HPS70CH-LED25CH	30	7	Yellow: Sodium vapor lamp	Cobrahead	1	Metal	Good	8 - 12 Ft	Average	
Asylum Road			HPS250CH-LED145CH	30	25	Yellow: Sodium vapor lamp	Cobrahead	1	Metal	Good	8 - 12 Ft	Good	
Main Street	334		HPS150CH-LED72CH	30	15	Yellow: Sodium vapor lamp	Cobrahead	1	Metal	Good	4 - 8 Ft	Good	
Asylum Road			HPS250CH-LED145CH	30	25	Yellow: Sodium vapor lamp	Cobrahead	1	Metal	Good	8 - 12 Ft	Good	
Asylum Road			HPS250CH-LED145CH	30	25	Yellow: Sodium vapor lamp	Cobrahead	1	Metal	Good	8 - 12 Ft	Good	
East Main Street	63	134015	HPS400CH-LED341CH	30	40	Yellow: Sodium vapor lamp	Cobrahead	1	Wood	Average	4 - 8 Ft	Average	
Asylum Road		1158	HPS250CH-LED145CH	30	25	Yellow: Sodium vapor lamp	Cobrahead	1	Metal	Good	8 - 12 Ft	Good	
East Main Street	80	32155	MV175CH-LED35CH	30	17	Blue: Mercury vapor	Cobrahead	1	Wood	Good	4 - 8 Ft	Average	
Main Street	352		HPS150CH-LED72CH	30	15	Yellow: Sodium vapor lamp	Cobrahead	1	Metal	Good	4 - 8 Ft	Good	
Asylum Road			HPS250CH-LED145CH	30	25	Yellow: Sodium vapor lamp	Cobrahead	1	Metal	Good	8 - 12 Ft	Good	
East Main Street	105	24155	HPS70CH-LED25CH	30	7	Yellow: Sodium vapor lamp	Cobrahead	1	Wood	Good	4 - 8 Ft	Average	
Main Street	364		HPS150CH-LED72CH	30	15	Yellow: Sodium vapor lamp	Cobrahead	1	Metal	Good	4 - 8 Ft	Good	
East Main Street		p35374	HPS150CH-LED72CH	30	15	Yellow: Sodium vapor lamp	Cobrahead	1	Wood	Average	4 - 8 Ft	Average	
Main Street			HPS150CH-LED72CH	30	15	Yellow: Sodium vapor lamp	Cobrahead	1	Metal	Good	4 - 8 Ft	Good	
Russell Avenue	11	p32659	HPS70CH-LED25CH	30	7	Yellow: Sodium vapor lamp	Cobrahead	1	Wood	Good	4 - 8 Ft	Average	
Asylum Road			HPS150CH-LED72CH	30	15	Yellow: Sodium vapor lamp	Cobrahead						





Dewindt Street	15	13153	HPS150CH-LED72CH	20	15	Yellow: Sodium vapor lamp	Cobrahead	1	Wood	Average	8 - 12 FT	Average	No sticker
South Cedar Street	15	49877	HPS150CH-LED72CH	20	15	Yellow: Sodium vapor lamp	Cobrahead	1	Wood	Average	4 - 8 FT	Average	
South Cedar Street	23	40986	HPS70CH-LED25CH	20	7	Yellow: Sodium vapor lamp	Cobrahead	1	Wood	Average	4 - 8 FT	Average	
Wolcott Avenue		111	HPS250TD-LED80TD	30	25	Yellow: Sodium vapor lamp	Teardrop	1	Wood	Good	4 - 8 FT	Good	
Wolcott Avenue		84887	HPS250TD-LED80TD	30	25	Yellow: Sodium vapor lamp	Teardrop	1	Wood	Good	4 - 8 FT	Good	
Wolcott Avenue		68589	HPS250TD-LED80TD	30	25	Yellow: Sodium vapor lamp	Teardrop	1	Wood	Good	4 - 8 FT	Good	
Wolcott Avenue	771	73519	HPS250TD-LED80TD	30	25	Yellow: Sodium vapor lamp	Teardrop	1	Wood	Good	4 - 8 FT	Good	
James Street	3	38206	MV175CH-LED35CH	20	17	Blue: Mercury vapor	Cobrahead	1	Wood	Average	4 - 8 FT	Average	No sticker
Beacon Street		24177	MV175CH-LED35CH	20	17	Blue: Mercury vapor	Cobrahead	1	Wood	Average	4 - 8 FT	Average	Not sticker
Beacon Street		133042	HPS150CH-LED72CH	20	15	Yellow: Sodium vapor lamp	Cobrahead	1	Wood	Average	4 - 8 FT	Average	
South Cedar Street		33075	HPS70CH-LED25CH	20	7	Yellow: Sodium vapor lamp	Cobrahead	1	Wood	Average	4 - 8 FT	Average	
South Cedar Street	39	49899	HPS150CH-LED72CH	20	15	Yellow: Sodium vapor lamp	Cobrahead	1	Wood	Average	4 - 8 FT	Average	
Wolcott Avenue		69590	HPS250TD-LED80TD	30	25	Yellow: Sodium vapor lamp	Teardrop	1	Wood	Good	4 - 8 FT	Good	
South Cedar Street		35363	HPS150CH-LED72CH	20	15	Yellow: Sodium vapor lamp	Cobrahead	1	Wood	Average	4 - 8 FT	Average	
South Cedar Street	9	20261	HPS70CH-LED25CH	20	7	Yellow: Sodium vapor lamp	Cobrahead	1	Wood	Average	4 - 8 FT	Average	
Wolcott Avenue		63796	HPS250TD-LED80TD	30	25	Yellow: Sodium vapor lamp	Teardrop	1	Wood	Good	4 - 8 FT	Good	
Wolcott Avenue		72731	HPS250TD-LED80TD	30	25	Yellow: Sodium vapor lamp	Teardrop	1	Wood	Good	4 - 8 FT	Good	
Howland Avenue		32655	HPS250TD-LED80TD	30	25	Yellow: Sodium vapor lamp	Teardrop	1	Wood	Good	4 - 8 FT	Good	
Wolcott Avenue		33200	HPS250TD-LED80TD	30	25	Yellow: Sodium vapor lamp	Teardrop	1	Wood	Good	4 - 8 FT	Good	
James Street		38208	HPS70CH-LED25CH	20	7	Yellow: Sodium vapor lamp	Cobrahead	1	Wood	Average	4 - 8 FT	Average	
Wolcott Avenue		35533	HPS250TD-LED80TD	30	25	Yellow: Sodium vapor lamp	Teardrop	1	Wood	Good	4 - 8 FT	Good	
Prospect Street		66631	HPS250TD-LED80TD	30	25	Yellow: Sodium vapor lamp	Teardrop	1	Wood	Good	4 - 8 FT	Good	
South Brett Street	45	142819	HPS70CH-LED25CH	20	7	Yellow: Sodium vapor lamp	Cobrahead	1	Wood	Average	4 - 8 FT	Average	No sticker
Wolcott Avenue		101041	HPS250CH-LED145CH	30	25	Yellow: Sodium vapor lamp	Cobrahead	1	Wood	Good	4 - 8 FT	Good	
Wolcott Avenue		134279	HPS250TD-LED80TD	30	25	Yellow: Sodium vapor lamp	Teardrop	1	Wood	Good	4 - 8 FT	Good	
South Brett Street	43	84324	HPS70CH-LED25CH	20	7	Yellow: Sodium vapor lamp	Cobrahead	1	Wood	Average	4 - 8 FT	Average	
Wolcott Avenue	832	63300	HPS250TD-LED80TD	30	25	Yellow: Sodium vapor lamp	Teardrop	1	Wood	Good	4 - 8 FT	Good	
Wolcott Avenue		74284	HPS250TD-LED80TD	30	25	Yellow: Sodium vapor lamp	Teardrop	1	Wood	Good	4 - 8 FT	Good	
Wolcott Avenue		134282	HPS250CH-LED145CH	30	25	Yellow: Sodium vapor lamp	Cobrahead	1	Wood	Good	4 - 8 FT	Good	
Wolcott Avenue		101040	HPS250TD-LED80TD	30	25	Yellow: Sodium vapor lamp	Teardrop	1	Wood	Good	4 - 8 FT	Good	
Ractor Street		78156	HPS250TD-LED80TD	30	25	Yellow: Sodium vapor lamp	Teardrop	1	Wood	Good	4 - 8 FT	Good	
South Brett Street	29	58374	MV175CH-LED35CH	20	17	Blue: Mercury vapor	Cobrahead	1	Wood	Average	4 - 8 FT	Average	No sticker
Wolcott Avenue		107577	HPS250TD-LED80TD	30	25	Yellow: Sodium vapor lamp	Teardrop	1	Wood	Good	4 - 8 FT	Good	
Simmons Lane		81917	HPS250TD-LED80TD	30	25	Yellow: Sodium vapor lamp	Teardrop	1	Wood	Good	4 - 8 FT	Good	
Simmons Lane	30	56760	HPS70CH-LED25CH	20	7	Yellow: Sodium vapor lamp	Cobrahead	1	Wood	Good	4 - 8 FT	Average	
Catherine Street	19	141312	HPS70CH-LED25CH	20	7	Yellow: Sodium vapor lamp	Cobrahead	1	Wood	Average	8 - 12 FT	Average	
Simmons Lane		56762	HPS70CH-LED25CH	20	7	Yellow: Sodium vapor lamp	Cobrahead	1	Wood	Good	4 - 8 FT	Average	Animal rescue property center possibly but ch
Simmons Lane	54	40264	HPS150CH-LED72CH	20	15	Yellow: Sodium vapor lamp	Cobrahead	1	Wood	Good	4 - 8 FT	Good	
South Brett Street	8	71891	HPS70CH-LED25CH	20	7	Yellow: Sodium vapor lamp	Cobrahead	1	Wood	Average	4 - 8 FT	Poor	
Wolcott Avenue				25		Other	Other	1	Metal	Good			Bridge dec, 1/4
Wolcott Avenue				25		Other	Other	1	Metal	Good			
Wolcott Avenue				25		Other	Other	1	Metal	Good			
Wolcott Avenue		68213	HPS250CH-LED145CH	30	25	Yellow: Sodium vapor lamp	Cobrahead	1	Wood	Good	8 - 12 FT	Good	
Catherine Street		35586	HPS70CH-LED25CH	20	7	Yellow: Sodium vapor lamp	Cobrahead	1	Wood	Average	4 - 8 FT	Average	
Wolcott Avenue		134455	HPS250CH-LED145CH	25	25	Yellow: Sodium vapor lamp	Cobrahead	1	Wood	Good	4 - 8 FT	Average	
Wolcott Avenue		134283	HPS250CH-LED145CH	30	25	Yellow: Sodium vapor lamp	Cobrahead	1	Wood	Good	4 - 8 FT	Average	
Catherine Street	117	61101	MV175CH-LED35CH	20	17	Blue: Mercury vapor	Cobrahead	1	Wood	Average	4 - 8 FT	Average	No sticker
Unnamed Street		164800	HPS150CH-LED72CH	20	15	Yellow: Sodium vapor lamp	Cobrahead	1	Wood	Good	4 - 8 FT	Good	
Unamed Street		164801	HPS150CH-LED72CH	20	15	Yellow: Sodium vapor lamp	Cobrahead	1	Wood	Good	4 - 8 FT	Good	
Unamed Street		164803	HPS150CH-LED72CH	30	15	Yellow: Sodium vapor lamp	Cobrahead	1	Wood	Good	4 - 8 FT	Good	
Catherine Street	95	13261	HPS70CH-LED25CH	20	7	Yellow: Sodium vapor lamp	Cobrahead	1	Wood	Average	4 - 8 FT	Average	
Unamed Street		164804	HPS150CH-LED72CH	20	15	Yellow: Sodium vapor lamp	Cobrahead	1	Wood	Good	4 - 8 FT	Good	
Catherine Street	65	57429	HPS70CH-LED25CH	20	7	Yellow: Sodium vapor lamp	Cobrahead	1	Wood	Average	4 - 8 FT	Average	
Unamed Street		164807	HPS150CH-LED72CH	20	15	Yellow: Sodium vapor lamp	Cobrahead	1	Wood	Good	4 - 8 FT	Average	
Fowler Street		38068	HPS70CH-LED25CH	30	7	Yellow: Sodium vapor lamp	Cobrahead	1	Wood	Good	4 - 8 FT	Average	
Fulton Avenue		193958	MV175CH-LED35CH	20	17	Blue: Mercury vapor	Cobrahead	1	Wood	Good	4 - 8 FT	Average	
Catherine Street	13	58250	HPS70CH-LED25CH	20	7	Yellow: Sodium vapor lamp	Cobrahead	1	Wood	Average	4 - 8 FT	Average	
John Street	29	82865	MV175CH-LED35CH	20	17	Blue: Mercury vapor	Cobrahead	1	Wood	Good	4 - 8 FT	Good	
Cliff Street	45	29240	HPS70CH-LED25CH	20	7	Yellow: Sodium vapor lamp	Cobrahead	1	Wood	Average	4 - 8 FT	Average	
Rombout Avenue		71220	HPS70CH-LED25CH	30	7	Yellow: Sodium vapor lamp	Cobrahead	1	Wood	Good	4 - 8 FT	Average	
Teller Avenue		24810	HPS70CH-LED25CH	30	7	Yellow: Sodium vapor lamp	Cobrahead	1	Wood	Good	4 - 8 FT	Good	
Van Nydeck Avenue		71225	HPS150CH-LED72CH	20	15	Yellow: Sodium vapor lamp	Cobrahead	1	Wood	Poor	4 - 8 FT	Average	
Van Nydeck Avenue		71216	HPS150CH-LED72CH	30	15	Yellow: Sodium vapor lamp	Cobrahead	1	Wood	Good	4 - 8 FT	Average	
Van Nydeck Avenue	10	18138	HPS70CH-LED25CH	20	7	Yellow: Sodium vapor lamp	Cobrahead	1	Wood	Poor	4 - 8 FT	Average	
Tioronda Avenue		23146	HPS150CH-LED72CH	20	15	Yellow: Sodium vapor lamp	Cobrahead	1	Wood	Poor	4 - 8 FT	Average	New pile in place
Tioronda Avenue		18137	HPS150CH-LED72CH	30	15	Yellow: Sodium vapor lamp	Cobrahead	1	Wood	Good	4 - 8 FT	Good	
Tioronda Avenue		42544	HPS400CH-LED241CH	30	40	Yellow: Sodium vapor lamp	Cobrahead	1	Wood	Average	4 - 8 FT	Good	
Wolcott Avenue		134460	HPS150CH-LED72CH	20	15	Yellow: Sodium vapor lamp	Cobrahead	1	Wood	Average	4 - 8 FT	Average	
Wolcott Avenue		134460	HPS400PT-LED135PT	30	40	Yellow: Sodium vapor lamp	Post Top	1	Wood	Average	4 - 8 FT	Average	
Dewindt Street		18158	HPS70CH-LED25CH	20	7	Yellow: Sodium vapor lamp	Cobrahead	1	Wood	Average	4 - 8 FT	Average	
Wolcott Avenue	923	66002	HPS250CH-LED145CH	30	25	Yellow: Sodium vapor lamp	Cobrahead	1	Wood	Average	4 - 8 FT	Average	
Dewindt Street		18155	MV175CH-LED35CH	20	17	Blue: Mercury vapor	Cobrahead	1	Wood	Average	4 - 8 FT	Average	No sticker
Sargent Avenue		68788	HPS70CH-LED25CH	25	7	Yellow: Sodium vapor lamp	Cobrahead	1	Wood	Average	4 - 8 FT	Average	
South Brett Street		18154	MV175CH-LED35CH	20	17	Blue: Mercury vapor	Cobrahead	1	Wood	Average	4 - 8 FT	Average	No sticker
Dewindt Street	89	134478	HPS150CH-LED72CH	20	15	Yellow: Sodium vapor lamp	Cobrahead	1	Wood	Average	4 - 8 FT	Average	
Fowler Street	19	134478	MV175CH-LED35CH	20	17	Blue: Mercury vapor	Cobrahead	1	Wood	Average	4 - 8 FT	Good	
Fowler Street	27	134479	MV175CH-LED35CH	30	17	Blue: Mercury vapor	Cobrahead	1	Wood	Good	4 - 8 FT	Average	
Dewindt Street		76500	MV175CH-LED35CH	20	17	Blue: Mercury vapor	Cobrahead	1	Wood	Average	4 - 8 FT	Average	No sticker
West Center Street		13428	HPS70CH-LED25CH	20	7	Yellow: Sodium vapor lamp	Cobrahead	1	Wood	Poor	4 - 8 FT	Average	
Unamed Street		164802	HPS150CH-LED72CH	30	15	Yellow: Sodium vapor lamp	Cobrahead	1	Wood	Good	4 - 8 FT	Good	Pole being replaced
Unamed Street		164805	HPS150CH-LED72CH	30	15	Yellow: Sodium vapor lamp	Cobrahead	1	Wood	Good	4 - 8 FT	Good	
Unamed Street		164806	HPS150CH-LED72CH	30	15	Yellow: Sodium vapor lamp	Cobrahead	1	Wood	Good	4 - 8 FT	Good	
Unamed Street		164808	HPS150CH-LED72CH	30	15	Yellow: Sodium vapor lamp	Cobrahead	1	Wood	Good	4 - 8 FT	Good	
Unamed Street		164809	HPS150CH-LED72CH	30	15	Yellow: Sodium vapor lamp	Cobrahead	1	Wood	Good	4 - 8 FT	Good	
Unamed Street		30040	HPS150CH-LED213FL	40	40	Yellow: Sodium vapor lamp	Flodlight	1	Wood	Good	4 - 8 FT	Good	Aimed at schools bus loop
Catherine Street		84263	HPS70CH-LED25CH	20	7	Yellow: Sodium vapor lamp	Cobrahead	1	Wood	Average	4 - 8 FT	Average	
Catherine Street	35	52069	MV175CH-LED35CH	20	17	Blue: Mercury vapor	Cobrahead	1	Wood	Average	4 - 8 FT	Average	No sticker
Fulton Avenue	94	61156	MV175CH-LED35CH	20	17	Blue: Mercury vapor	Cobrahead	1	Wood	Good	4 - 8 FT	Good	
Fulton Avenue		134335	HPS70CH-LED25CH	30	7	Yellow: Sodium vapor lamp	Cobrahead	1	Wood	Good	4 - 8 FT	Good	
Vine Street	111	71383	MV175CH-LED35CH	20	17	Blue: Mercury vapor	Cobrahead	1	Wood	Good	4 - 8 FT	Average	
Hubert Street	7	134354	HPS70CH-LED25CH	20	7	Yellow: Sodium vapor lamp	Cobrahead	1	Wood	Average	4 - 8 FT	Average	
Vine Street		62278	HPS70CH-LED25CH	20	7	Yellow: Sodium vapor lamp	Cobrahead	1	Wood	Good	4 - 8 FT	Good	
John Street		50148	HPS70CH-LED25CH	20	7	Yellow: Sodium vapor lamp	Cobrahead	1	Wood	Good	4 - 8 FT	Average	
Cliff Street	41	42401	HPS70CH-LED25CH	20	7	Yellow: Sodium vapor lamp	Cobrahead	1	Wood	Average	4 - 8 FT	Average	
Teller Avenue	113	71383	HPS250CH-LED145CH	30	25	Yellow: Sodium vapor lamp	Cobrahead	1	Metal	Good	4 - 8 FT	Good	
Van Nydeck Avenue		71883	HPS250CH-LED145CH	30	25	Yellow: Sodium vapor lamp	Cobrahead	1	Metal	Good	4 - 8 FT	Good	
Main Street		beac1024	HPS250CH-LED145CH	30	25	Yellow: Sodium vapor lamp	Cobrahead	1	Metal	Good	4 - 8 FT	Good	
Main Street		134366	HPS250CH-LED145CH	30	25	Yellow: Sodium vapor lamp	Cobrahead	1	Wood	Average	4 - 8 FT	Average	
Commerce Street		134366	HPS70CH-LED25CH	20	7	Yellow: Sodium vapor lamp	Cobrahead	1	Wood	Average	4 - 8 FT	Average	
Commerce Street		24801	MV175CH-LED35CH	20	17	Blue: Mercury vapor	Cobrahead	1	Wood	Average	4 - 8 FT	Average	No sticker
Tioronda Avenue		125633	HPS70CH-LED25CH	30	7	Yellow: Sodium vapor lamp	Cobrahead	1	Wood	Poor	4 - 8 FT	Average	New Pole in place
Tioronda Avenue		134288	HPS70CH-LED25CH	30	7	Yellow: Sodium vapor lamp	Cobrahead	1	Wood	Average	4 - 8 FT	Average	
Tioronda Avenue		134287	HPS70CH-LED25CH	30	7	Yellow: Sodium vapor lamp	Cobrahead	1	Wood	Poor	4 - 8 FT	Average	
Dewindt Street	13	18162	HPS70CH-LED25CH	20	7	Yellow: Sodium vapor lamp	Cobrahead	1	Wood	Average	4 - 8 FT	Average	
Tioronda Avenue			HPS150CH-LED72CH	20	15	Yellow: Sodium vapor lamp	Cobrahead	1	Wood	Good	4 - 8 FT	Average	
Tioronda Avenue		134285	HPS150CH-LED72CH	30	15	Yellow: Sodium vapor lamp	Cobrahead	1	Wood	Average	4 - 8 FT	Average	
Dewindt Street	21	402134	MV175CH-LED35CH	20	17	Blue: Mercury vapor	Cobrahead	1	Wood	Average	4 - 8 FT	Average	No sticker
Dewindt Street		18159	MV175CH-LED35CH	20	17	Blue: Mercury vapor	Cobrahead	1	Wood	Average	4 - 8 FT	Average	No sticker
Wolcott Avenue	925	134462	HPS250CH-LED145CH	30	25	Yellow: Sodium vapor lamp	Cobrahead	1	Wood	Poor	4 - 8 FT	Average	No sticker
Dewindt Street			MV175CH-LED35CH	20	17	Blue: Mercury vapor	Cobrahead	1	Wood	Average	4 - 8 FT	Average	No sticker
Teller Avenue		24817	HPS250CH-LED145CH	30	25	Yellow: Sodium vapor lamp	Cobrahead	1					

Dinan Street	64	27201	HPS70CH-LED25CH	20	7	Yellow: Sodium vapor lamp	Cobrahead	1	Wood	Average	4 - 8 Ft	Average	
South Chestnut Street		129101	HPS70CH-LED25CH	30	7	Yellow: Sodium vapor lamp	Cobrahead	1	Wood	Average	4 - 8 Ft	Average	
Dowdell Street	67	76500	MV175CH-LED35CH	20	17	Blue: Mercury vapor	Cobrahead	1	Wood	Good	4 - 8 Ft	Average	
Rombout Avenue	67	70395	HPS150CH-LED72CH	30	15	Yellow: Sodium vapor lamp	Cobrahead	1	Wood	Average	4 - 8 Ft	Average	
Rombout Avenue	87	134360	HPS70CH-LED25CH	20	7	Yellow: Sodium vapor lamp	Cobrahead	1	Wood	Average	4 - 8 Ft	Average	
School Street	103	134359	MV175CH-LED35CH	20	17	Blue: Mercury vapor	Cobrahead	1	Wood	Average	4 - 8 Ft	Average	NO STICKER
Rombout Avenue		134357	MV175CH-LED35CH	20	17	Blue: Mercury vapor	Cobrahead	1	Wood	Average	4 - 8 Ft	Average	No sticker
Driveaway		134351	HPS70CH-LED25CH	20	7	Yellow: Sodium vapor lamp	Cobrahead	1	Wood	Average	4 - 8 Ft	Average	
Rombout Avenue		58373	MV175CH-LED35CH	20	17	Blue: Mercury vapor	Cobrahead	1	Wood	Average	4 - 8 Ft	Average	No sticker
Rombout Avenue	192	55253	MV175CH-LED35CH	20	17	Blue: Mercury vapor	Cobrahead	1	Wood	Average	4 - 8 Ft	Average	No sticker
James Street			MV175CH-LED35CH	20	17	Blue: Mercury vapor	Cobrahead	1	Wood	Average	4 - 8 Ft	Average	
West Center Street		106191	HPS150CH-LED72CH	20	15	Yellow: Sodium vapor lamp	Cobrahead	1	Wood	Average	4 - 8 Ft	Average	
West Center Street			HPS70CH-LED25CH	20	7	Yellow: Sodium vapor lamp	Cobrahead	1	Wood	Average	4 - 8 Ft	Average	
West Center Street			MV175CH-LED35CH	20	17	Blue: Mercury vapor	Cobrahead	1	Wood	Average	4 - 8 Ft	Average	
School Street			HPS70CH-LED25CH	20	7	Yellow: Sodium vapor lamp	Cobrahead	1	Wood	Average	4 - 8 Ft	Average	
Spring Valley Street	164	134595	MV175CH-LED35CH	25	17	Blue: Mercury vapor	Cobrahead	1	Wood	Good	4 - 8 Ft	Average	
Spring Valley Street		106267	MV175CH-LED35CH	30	17	Blue: Mercury vapor	Cobrahead	1	Wood	Good	4 - 8 Ft	Average	Fixt needs to be moved to New pole
West Center Street	12	106197	HPS150CH-LED72CH	20	15	Yellow: Sodium vapor lamp	Cobrahead	1	Wood	Average	4 - 8 Ft	Average	
Spring Valley Street	125	106265	MV175CH-LED35CH	30	17	Blue: Mercury vapor	Cobrahead	1	Wood	Good	4 - 8 Ft	Average	
West Center Street	8	79163	HPS150CH-LED72CH	20	15	Yellow: Sodium vapor lamp	Cobrahead	1	Wood	Average	4 - 8 Ft	Average	
Spring Valley Street		134600	HPS70CH-LED25CH	30	7	Yellow: Sodium vapor lamp	Cobrahead	1	Wood	Good	4 - 8 Ft	Average	FIXT needs to be moved to new pole
Spring Valley Street		134603	HPS70CH-LED25CH	30	7	Yellow: Sodium vapor lamp	Cobrahead	1	Wood	Average	4 - 8 Ft	Average	
School Street	12	134363	MV175CH-LED35CH	25	17	Blue: Mercury vapor	Cobrahead	1	Wood	Average	4 - 8 Ft	Average	No sticker
Churchill Street		134604	HPS70CH-LED25CH	30	7	Yellow: Sodium vapor lamp	Cobrahead	1	Wood	Average	4 - 8 Ft	Average	
Churchill Street		56780	HPS150CH-LED72CH	30	15	Yellow: Sodium vapor lamp	Cobrahead	1	Wood	Good	4 - 8 Ft	Good	Fixt needs to be moved to new pole
Churchill Street		50778	HPS150CH-LED72CH	30	15	Yellow: Sodium vapor lamp	Cobrahead	1	Wood	Average	4 - 8 Ft	Average	
Churchill Street		149480	HPS70CH-LED25CH	30	7	Yellow: Sodium vapor lamp	Cobrahead	1	Wood	Good	4 - 8 Ft	Average	Fixt needs to be moved to new pole
South Avenue	45		HPS150CH-LED72CH	25	15	Yellow: Sodium vapor lamp	Cobrahead	1	Metal	Good	4 - 8 Ft	Average	
South Avenue			HPS250CH-LED145CH	20	25	Yellow: Sodium vapor lamp	Cobrahead	1	Metal	Good	4 - 8 Ft	Average	
East Main Street		134628	HPS150CH-LED72CH	30	15	Yellow: Sodium vapor lamp	Cobrahead	1	Wood	Average	4 - 8 Ft	Average	
South Avenue			HPS250CH-LED145CH	20	25	Yellow: Sodium vapor lamp	Cobrahead	1	Metal	Good	4 - 8 Ft	Average	
East Main Street		133349	MV175CH-LED35CH	30	17	Blue: Mercury vapor	Cobrahead	1	Wood	Good	4 - 8 Ft	Average	
South Avenue			HPS250CH-LED145CH	20	25	Yellow: Sodium vapor lamp	Cobrahead	1	Metal	Good	4 - 8 Ft	Average	
East Main Street		24940	HPS250CH-LED145CH	20	25	Yellow: Sodium vapor lamp	Cobrahead	1	Wood	Good	4 - 8 Ft	Average	
South Avenue			HPS250CH-LED145CH	20	25	Yellow: Sodium vapor lamp	Cobrahead	1	Metal	Good	4 - 8 Ft	Average	
South Avenue			HPS250CH-LED145CH	20	25	Yellow: Sodium vapor lamp	Cobrahead	1	Metal	Good	4 - 8 Ft	Average	
East Main Street	36	134617	HPS250CH-LED145CH	20	25	Yellow: Sodium vapor lamp	Cobrahead	1	Metal	Good	4 - 8 Ft	Average	
South Avenue			HPS250CH-LED145CH	20	25	Yellow: Sodium vapor lamp	Cobrahead	1	Metal	Good	4 - 8 Ft	Average	
South Avenue	75		HPS250CH-LED145CH	20	25	Yellow: Sodium vapor lamp	Cobrahead	1	Metal	Good	4 - 8 Ft	Average	Sticker number 25
Water Street		140109	HPS70CH-LED25CH	30	7	Yellow: Sodium vapor lamp	Cobrahead	1	Wood	Average	4 - 8 Ft	Average	
Water Street	15	134610	HPS70CH-LED25CH	25	7	Yellow: Sodium vapor lamp	Cobrahead	1	Wood	Average	4 - 8 Ft	Average	
South Avenue	75		HPS250CH-LED145CH	20	25	Yellow: Sodium vapor lamp	Cobrahead	1	Metal	Good	4 - 8 Ft	Average	
Water Street	39	140107	HPS70CH-LED25CH	30	7	Yellow: Sodium vapor lamp	Cobrahead	1	Wood	Average	4 - 8 Ft	Average	
South Avenue			HPS250CH-LED145CH	20	25	Yellow: Sodium vapor lamp	Cobrahead	1	Metal	Good	4 - 8 Ft	Average	
Spring Valley Street		84143	HPS70CH-LED25CH	30	7	Yellow: Sodium vapor lamp	Cobrahead	1	Wood	Good	4 - 8 Ft	Average	
South Avenue			HPS250CH-LED145CH	20	25	Yellow: Sodium vapor lamp	Cobrahead	1	Metal	Good	4 - 8 Ft	Average	
Saint Lukes Place	26	133043	HPS70CH-LED25CH	30	7	Yellow: Sodium vapor lamp	Cobrahead	1	Wood	Good	4 - 8 Ft	Average	
Churchill Street		134591	HPS70CH-LED25CH	30	7	Yellow: Sodium vapor lamp	Cobrahead	1	Wood	Good	4 - 8 Ft	Good	Fixt needs to be moved to new pole
Saint Lukes Place	38	134559	HPS70CH-LED25CH	30	7	Yellow: Sodium vapor lamp	Cobrahead	1	Wood	Average	4 - 8 Ft	Average	
Union Street		39936	HPS70CH-LED25CH	30	7	Yellow: Sodium vapor lamp	Cobrahead	1	Wood	Average	4 - 8 Ft	Average	
Union Street	20	135943	HPS70CH-LED25CH	30	7	Yellow: Sodium vapor lamp	Cobrahead	1	Wood	Good	4 - 8 Ft	Average	
Union Street		134601	HPS70CH-LED25CH	30	7	Yellow: Sodium vapor lamp	Cobrahead	1	Wood	Average	4 - 8 Ft	Average	
Rector Street	31	134591	HPS70CH-LED25CH	30	7	Yellow: Sodium vapor lamp	Cobrahead	1	Wood	Good	4 - 8 Ft	Average	
Rector Street		134859	MV175CH-LED35CH	30	17	Blue: Mercury vapor	Cobrahead	1	Wood	Good	4 - 8 Ft	Average	
Davies Avenue			HPS250CH-LED145CH	20	25	Yellow: Sodium vapor lamp	Cobrahead	1	Wood	Average	8 - 12 FT	Average	
Stratford Avenue	4	106282	HPS70CH-LED25CH	20	7	Yellow: Sodium vapor lamp	Cobrahead	1	Wood	Average	4 - 8 Ft	Average	
Helen Court			HPS70PT-LED35PT	20	7	Yellow: Sodium vapor lamp	Post Top	1	Wood	Average			
Bayview Avenue	5		HPS150CH-LED72CH	20	15	Yellow: Sodium vapor lamp	Cobrahead	1	Wood	Average	8 - 12 FT	Average	
Bayview Avenue		39978	HPS70CH-LED25CH	20	7	Yellow: Sodium vapor lamp	Cobrahead	1	Wood	Average	4 - 8 Ft	Average	
Bayview Avenue	27	182679	MV175CH-LED35CH	20	17	Blue: Mercury vapor	Cobrahead	1	Wood	Average	4 - 8 Ft	Average	No sticker
Kittridge Place	4	133090	HPS70CH-LED25CH	30	7	Yellow: Sodium vapor lamp	Cobrahead	1	Wood	Average	4 - 8 Ft	Average	
Kittridge Place		133091	HPS70CH-LED25CH	30	7	Yellow: Sodium vapor lamp	Cobrahead	1	Wood	Average	4 - 8 Ft	Average	
Spring Valley Street		134607	HPS150CH-LED72CH	25	15	Yellow: Sodium vapor lamp	Cobrahead	1	Wood	Poor	4 - 8 Ft	Average	
Saint Lukes Place		132312	HPS70CH-LED25CH	30	7	Yellow: Sodium vapor lamp	Cobrahead	1	Wood	Good	4 - 8 Ft	Average	
Churchill Street		13463	MV175CH-LED35CH	30	17	Blue: Mercury vapor	Cobrahead	1	Wood	Average	4 - 8 Ft	Average	
Union Street		56274	HPS150CH-LED72CH	30	15	Yellow: Sodium vapor lamp	Cobrahead	1	Wood	Good	4 - 8 Ft	Average	
Rector Street		27167	HPS70CH-LED25CH	30	7	Yellow: Sodium vapor lamp	Cobrahead	1	Wood	Average	4 - 8 Ft	Average	
Davies Avenue			HPS250CH-LED145CH	20	25	Yellow: Sodium vapor lamp	Cobrahead	1	Wood	Average	8 - 12 FT	Average	
Bartholli Court		402313	HPS250CH-LED145CH	20	25	Yellow: Sodium vapor lamp	Cobrahead	1	Wood	Average	8 - 12 FT	Average	
Davies Avenue			HPS250CH-LED145CH	20	25	Yellow: Sodium vapor lamp	Cobrahead	1	Wood	Average	8 - 12 FT	Average	
Stratford Avenue	10	35973	HPS70CH-LED25CH	20	7	Yellow: Sodium vapor lamp	Cobrahead	1	Wood	Average	4 - 8 Ft	Average	
South Avenue			HPS250CH-LED145CH	20	25	Yellow: Sodium vapor lamp	Cobrahead	1	Metal	Good	4 - 8 Ft	Average	
Hammond Plaza			HPS70CH-LED25CH	20	7	Yellow: Sodium vapor lamp	Cobrahead	1	Wood	Average	4 - 8 Ft	Average	
Harbor View Court	517		HPS70PT-LED35PT	15	7	Yellow: Sodium vapor lamp	Post Top	1	Metal	Average			
Tompkins Terrace		134385	MV175CH-LED35CH	20	17	Blue: Mercury vapor	Cobrahead	1	Wood	Average	4 - 8 Ft	Average	No sticker
High Street	26	134435	HPS70CH-LED25CH	20	7	Yellow: Sodium vapor lamp	Cobrahead	1	Wood	Average	4 - 8 Ft	Average	
High Street	16	132	HPS70CH-LED25CH	20	7	Yellow: Sodium vapor lamp	Cobrahead	1	Wood	Average	4 - 8 Ft	Average	No sticker
High Street	7		HPS70CH-LED25CH	20	7	Yellow: Sodium vapor lamp	Cobrahead	1	Wood	Average	4 - 8 Ft	Average	
River Street	406	25676	HPS70CH-LED25CH	20	7	Yellow: Sodium vapor lamp	Cobrahead	1	Wood	Average	4 - 8 Ft	Average	
River Street	418	125674	HPS70CH-LED25CH	20	7	Yellow: Sodium vapor lamp	Cobrahead	1	Wood	Average	4 - 8 Ft	Average	
Lafayette Avenue	13	134417	HPS70CH-LED25CH	20	7	Yellow: Sodium vapor lamp	Cobrahead	1	Wood	Average	4 - 8 Ft	Average	
Bellevue Lane	9		MV175PT-LED48PT	15	17	Blue: Mercury vapor	Post Top	1	Metal	Average			
Monell Place		134420	HPS150CH-LED72CH	20	15	Yellow: Sodium vapor lamp	Cobrahead	1	Wood	Average	4 - 8 Ft	Average	
Monell Place	3	41010	HPS70CH-LED25CH	20	7	Yellow: Sodium vapor lamp	Cobrahead	1	Wood	Average	4 - 8 Ft	Average	
River Street	8	125677	MV175CH-LED35CH	20	17	Blue: Mercury vapor	Cobrahead	1	Wood	Average	4 - 8 Ft	Average	No sticker
Wolcott Avenue			HPS250CH-LED145CH	20	25	Yellow: Sodium vapor lamp	Cobrahead	1	Metal	Good	4 - 8 Ft	Average	
Wesley Avenue	111	38151	HPS70CH-LED25CH	20	7	Yellow: Sodium vapor lamp	Cobrahead	1	Wood	Average	4 - 8 Ft	Average	
Wesley Avenue	60	36272	HPS70CH-LED25CH	20	7	Yellow: Sodium vapor lamp	Cobrahead	1	Wood	Average	4 - 8 Ft	Average	
Wesley Avenue		36275	HPS70CH-LED25CH	20	7	Yellow: Sodium vapor lamp	Cobrahead	1	Wood	Average	4 - 8 Ft	Average	
Liberty Street	486	36005	HPS70CH-LED25CH	20	7	Yellow: Sodium vapor lamp	Cobrahead	1	Wood	Average	4 - 8 Ft	Average	
Liberty Street		35996	HPS70CH-LED25CH	20	7	Yellow: Sodium vapor lamp	Cobrahead	1	Wood	Average	4 - 8 Ft	Average	
Liberty Street	463	69232	HPS150CH-LED72CH	20	15	Yellow: Sodium vapor lamp	Cobrahead	1	Wood	Average	4 - 8 Ft	Average	
Liberty Street	433	69230	MV175CH-LED35CH	20	17	Blue: Mercury vapor	Cobrahead	1	Wood	Average	8 - 12 FT	Average	
Liberty Street	358	35994	HPS70CH-LED25CH	20	7	Yellow: Sodium vapor lamp	Cobrahead	1	Wood	Average	8 - 12 FT	Average	
Liberty Street	345	134665	MV175CH-LED35CH	20	17	Blue: Mercury vapor	Cobrahead	1	Wood	Average	4 - 8 Ft	Average	No sticker
Liberty Street	268	p150	HPS70CH-LED25CH	20	7	Yellow: Sodium vapor lamp	Cobrahead	1	Wood	Average	4 - 8 Ft	Average	
Bridge Street		4929	HPS70CH-LED25CH	20	7	Yellow: Sodium vapor lamp	Cobrahead	1	Wood	Average	4 - 8 Ft	Average	
Wilson Street	27	134542	HPS70CH-LED25CH	20	7	Yellow: Sodium vapor lamp	Cobrahead	1	Wood	Average	4 - 8 Ft	Average	
Wilson Street	37	134541	HPS70CH-LED25CH	20	7	Yellow: Sodium vapor lamp	Cobrahead	1	Wood	Average	4 - 8 Ft	Average	
Wilson Street	71	70373	HPS70CH-LED25CH	20	7	Yellow: Sodium vapor lamp	Cobrahead	1	Wood	Average	4 - 8 Ft	Average	
Wilson Street	144	134538	MV175CH-LED35CH	20	17	Blue: Mercury vapor	Cobrahead	1	Wood	Poor	4 - 8 Ft	Average	No sticker
Unnamed Street		125669	MV250CH-LED54CH	30	25	Blue: Mercury vapor	Cobrahead	1	Wood	Good	4 - 8 Ft	Average	
Knevels Avenue		121288	HPS70CH-LED25CH	20	7	Yellow: Sodium vapor lamp	Cobrahead	1	Wood	Average	4 - 8 Ft	Average	
Beekman Street			HPS250CH-LED145CH	20	25	Yellow: Sodium vapor lamp	Cobrahead	1	Metal	Good	4 - 8 Ft	Good	
Ferry Street			HPS150CH-LED72CH	20	15	Yellow: Sodium vapor lamp	Cobrahead	1	Wood	Average	4 - 8 Ft	Average	
Hammond Plaza		149416	HPS250CH-LED145CH	20	25	Yellow: Sodium vapor lamp	Cobrahead	1	Wood	Average	4 - 8 Ft	Average	
Harbor View Court	502		HPS70PT-LED35PT	15	7	Yellow: Sodium vapor lamp	Post Top	1	Metal	Average			
Harbor View Court	510		HPS70PT-LED35PT	15	7	Yellow: Sodium vapor lamp	Post Top	1	Metal	Average			
Harbor View Court			HPS70PT-LED35PT	15	7	Yellow: Sodium vapor lamp	Post Top	1	Metal	Average			
Harbor View Court	528		HPS70PT-LED35PT	15	7	Yellow: Sodium vapor lamp	Post Top	1	Metal	Average			
Tompkins Terrace		134383	MV175CH-LED35CH	20	17	Blue: Mercury vapor	Cobrahead	1	Wood	Average	4 - 8 Ft	Average	
River Street	428		HPS250CH-LED145CH	20	25	Yellow: Sodium vapor lamp	Cobrahead	1	Metal	Good	4 - 8 Ft	Average	

Helen Court			HPS70PT-LED35PT	20	7	Yellow: Sodium vapor lamp	Post Top	1	Wood	Good		
Beekman Street			HPS150CH-LED72CH	30	15	Yellow: Sodium vapor lamp	Cobrahead	1	Metal	Good	4 - 8 Ft	Good
Helen Court			HPS70PT-LED35PT	20	7	Yellow: Sodium vapor lamp	Post Top	1	Wood	Good		
Washington Avenue	503	36009	MV175CH-LED35CH	25	17	Blue: Mercury vapor	Cobrahead	1	Wood	Average	4 - 8 Ft	Average
Washington Avenue			HPS70PT-LED35PT	20	7	Yellow: Sodium vapor lamp	Post Top	1	Wood	Good		
Washington Avenue		36008	MV175CH-LED35CH	30	17	Blue: Mercury vapor	Cobrahead	1	Wood	Average	4 - 8 Ft	Average
Washington Avenue		110599	MV175CH-LED35CH	30	17	Blue: Mercury vapor	Cobrahead	1	Wood	Good	4 - 8 Ft	Good
Washington Avenue		24908	HPS70CH-LED25CH	30	7	Yellow: Sodium vapor lamp	Cobrahead	1	Wood	Average	4 - 8 Ft	Average
Washington Avenue		132549	HPS70CH-LED25CH	30	7	Yellow: Sodium vapor lamp	Cobrahead	1	Wood	Average	4 - 8 Ft	Average
Unnamed Street		36007	MV175CH-LED35CH	30	17	Blue: Mercury vapor	Cobrahead	1	Wood	Average	4 - 8 Ft	Average
Beekman Street		149415	HPS150CH-LED72CH	25	15	Yellow: Sodium vapor lamp	Cobrahead	1	Wood	Average	4 - 8 Ft	Average
Washington Avenue		134527	HPS70CH-LED25CH	30	7	Yellow: Sodium vapor lamp	Cobrahead	1	Wood	Good	4 - 8 Ft	Average
Washington Avenue		33891	MV175CH-LED35CH	30	17	Blue: Mercury vapor	Cobrahead	1	Wood	Average	4 - 8 Ft	Average
Wood Lane	1	85925	MV175CH-LED35CH	20	17	Blue: Mercury vapor	Cobrahead	1	Wood	Average	4 - 8 Ft	Average
Washington Avenue		134524	HPS70CH-LED25CH	30	7	Yellow: Sodium vapor lamp	Cobrahead	1	Wood	Good	4 - 8 Ft	Average
Washington Avenue		134522	HPS70CH-LED25CH	30	7	Yellow: Sodium vapor lamp	Cobrahead	1	Wood	Good	4 - 8 Ft	Good
Washington Avenue		134521	HPS70CH-LED25CH	30	7	Yellow: Sodium vapor lamp	Cobrahead	1	Wood	Average	4 - 8 Ft	Average
Washington Avenue		189443	HPS70CH-LED25CH	30	7	Yellow: Sodium vapor lamp	Cobrahead	1	Wood	Good	4 - 8 Ft	Average
Washington Avenue		134519	HPS70CH-LED25CH	30	7	Yellow: Sodium vapor lamp	Cobrahead	1	Wood	Average	4 - 8 Ft	Average
Red Flynn Drive		41093	HPS250CH-LED145CH	20	25	Yellow: Sodium vapor lamp	Cobrahead	1	Wood	Average	9 - 12 Ft	Average
Washington Avenue	264	35880	HPS70CH-LED25CH	30	7	Yellow: Sodium vapor lamp	Cobrahead	1	Wood	Average	4 - 8 Ft	Average
Washington Avenue		72366	HPS70CH-LED25CH	30	7	Yellow: Sodium vapor lamp	Cobrahead	1	Wood	Average	4 - 8 Ft	Average
Red Flynn Drive		41106	HPS250CH-LED145CH	20	25	Yellow: Sodium vapor lamp	Cobrahead	1	Wood	Average	4 - 8 Ft	Average
Washington Avenue		134629	HPS70CH-LED25CH	30	7	Yellow: Sodium vapor lamp	Cobrahead	1	Wood	Average	4 - 8 Ft	Average
Red Flynn Drive		30427	HPS150CH-LED72CH	20	15	Yellow: Sodium vapor lamp	Cobrahead	1	Wood	Average	4 - 8 Ft	Average
Deputzer Avenue	62	72318	MV175CH-LED35CH	30	17	Blue: Mercury vapor	Cobrahead	1	Wood	Good	4 - 8 Ft	Average
Violet Drive	15	72319	HPS70CH-LED25CH	30	7	Yellow: Sodium vapor lamp	Cobrahead	1	Wood	Average	4 - 8 Ft	Average
Violet Drive	21	72320	HPS70CH-LED25CH	30	7	Yellow: Sodium vapor lamp	Cobrahead	1	Wood	Average	4 - 8 Ft	Average
Robin Lane	10	75282	HPS70CH-LED25CH	30	7	Yellow: Sodium vapor lamp	Cobrahead	1	Wood	Average	4 - 8 Ft	Average
Maddox Place	5	79001	HPS70CH-LED25CH	30	7	Yellow: Sodium vapor lamp	Cobrahead	1	Wood	Average	4 - 8 Ft	Average
Violet Drive		72321	MV100CH-LED25CH	30	10	Blue: Mercury vapor	Cobrahead	1	Wood	Average	4 - 8 Ft	Average
Violet Drive		83855	MV175CH-LED35CH	30	17	Blue: Mercury vapor	Cobrahead	1	Wood	Good	4 - 8 Ft	Average
Jessen Place	82	83857	MV175CH-LED35CH	30	17	Blue: Mercury vapor	Cobrahead	1	Wood	Good	4 - 8 Ft	Average
Jessen Place		83859	HPS70CH-LED25CH	30	7	Yellow: Sodium vapor lamp	Cobrahead	1	Wood	Good	4 - 8 Ft	Average

Depuyter Avenue	144	102295	MV175CH-LED35CH	30	17	Blue: Mercury vapor	Cobrahead	1	Wood	Average	4 - 8 Ft	Average	
Depuyter Avenue		40066	MV175CH-LED35CH	30	17	Blue: Mercury vapor	Cobrahead	1	Wood	Average	4 - 8 Ft	Average	
Knevels Avenue	41	121281	HP570CH-LED25CH	20	7	Yellow: Sodium vapor lamp	Cobrahead	1	Wood	Average	4 - 8 Ft	Average	
Davidson Street		115338	HP570CH-LED25CH	30	7	Yellow: Sodium vapor lamp	Cobrahead	1	Wood	Average	4 - 8 Ft	Good	
Depuyter Avenue		134518	HP570CH-LED25CH	30	7	Yellow: Sodium vapor lamp	Cobrahead	1	Wood	Good	4 - 8 Ft	Average	
Depuyter Avenue	106	134516	HP570CH-LED25CH	30	7	Yellow: Sodium vapor lamp	Cobrahead	1	Wood	Good	4 - 8 Ft	Average	
Depuyter Avenue		42472	HP5150CH-LED72CH	30	15	Yellow: Sodium vapor lamp	Cobrahead	1	Wood	Good	4 - 8 Ft	Average	
Depuyter Avenue	80	27003	MV175CH-LED35CH	30	17	Blue: Mercury vapor	Cobrahead	1	Wood	Average	4 - 8 Ft	Average	
Grove Street	96	149843	HP5150CH-LED72CH	30	15	Yellow: Sodium vapor lamp	Cobrahead	1	Wood	Average	4 - 8 Ft	Average	
Grove Street		50149	HP570CH-LED25CH	30	7	Yellow: Sodium vapor lamp	Cobrahead	1	Wood	Average	4 - 8 Ft	Average	
Grove Street		66648	HP5150CH-LED72CH	30	15	Yellow: Sodium vapor lamp	Cobrahead	1	Wood	Average	4 - 8 Ft	Average	
Depuyter Avenue		68004	MV175CH-LED35CH	30	17	Blue: Mercury vapor	Cobrahead	1	Wood	Average	4 - 8 Ft	Average	
Falconer Street	75	29088	MV175CH-LED35CH	30	17	Blue: Mercury vapor	Cobrahead	1	Wood	Average	4 - 8 Ft	Good	
Howland Avenue		102229	MV175CH-LED35CH	30	17	Blue: Mercury vapor	Cobrahead	1	Wood	Average	4 - 8 Ft	Average	
Howland Avenue	27	70380	MV175CH-LED35CH	30	17	Blue: Mercury vapor	Cobrahead	1	Wood	Average	4 - 8 Ft	Average	
Howland Avenue		80492	MV175CH-LED35CH	30	17	Blue: Mercury vapor	Cobrahead	1	Wood	Good	4 - 8 Ft	Average	
Howland Avenue	110	81573	HP570CH-LED25CH	30	7	Yellow: Sodium vapor lamp	Cobrahead	1	Wood	Average	4 - 8 Ft	Average	
Howland Avenue		64783	MV175CH-LED35CH	30	17	Blue: Mercury vapor	Cobrahead	1	Wood	Average	4 - 8 Ft	Average	
Howland Avenue			MV175CH-LED35CH	30	17	Blue: Mercury vapor	Cobrahead	1	Wood	Average	4 - 8 Ft	Average	
South Avenue		27121	HP570CH-LED25CH	20	7	Yellow: Sodium vapor lamp	Cobrahead	1	Wood	Average	4 - 8 Ft	Average	
South Avenue	548	59898	HP5250CH-LED145CH	20	25	Yellow: Sodium vapor lamp	Cobrahead	1	Wood	Average	4 - 8 Ft	Average	
Unnamed Street		180904	HP570PT-LED35PT	12	7	Yellow: Sodium vapor lamp	Post Top	1	Metal	Average			
Unnamed Street		180905	HP570PT-LED35PT	12	7	Yellow: Sodium vapor lamp	Post Top	1	Metal	Good			
Unnamed Street		180906	HP570PT-LED35PT	20	7	Yellow: Sodium vapor lamp	Post Top	1	Metal	Average			
Tioronda Avenue		126488	HP570CH-LED25CH	30	7	Yellow: Sodium vapor lamp	Cobrahead	1	Wood	Average	4 - 8 Ft	Average	
Tioronda Avenue	351	120490	HP5150CH-LED72CH	30	15	Yellow: Sodium vapor lamp	Cobrahead	1	Wood	Good	8 - 12 FT	Good	
Tioronda Avenue	335	120492	HP570CH-LED25CH	20	7	Yellow: Sodium vapor lamp	Cobrahead	1	Wood	Average	4 - 8 Ft	Average	
Tioronda Avenue			HP570CH-LED25CH	20	7	Yellow: Sodium vapor lamp	Cobrahead	1	Wood	Average	4 - 8 Ft	Average	No sticker
Howland Avenue		134548	HP5150CH-LED72CH	30	15	Yellow: Sodium vapor lamp	Cobrahead	1	Wood	Average	4 - 8 Ft	Average	
Tioronda Avenue		120496	MV175CH-LED35CH	30	17	Blue: Mercury vapor	Cobrahead	1	Wood	Average	4 - 8 Ft	Average	No sticker
Tioronda Avenue		120498	HP570CH-LED25CH	20	7	Yellow: Sodium vapor lamp	Cobrahead	1	Wood	Average	4 - 8 Ft	Average	No sticker
Tioronda Avenue		120798	HP570CH-LED25CH	20	7	Yellow: Sodium vapor lamp	Cobrahead	1	Wood	Average	4 - 8 Ft	Average	
Tioronda Avenue		121248	HP570CH-LED25CH	20	7	Yellow: Sodium vapor lamp	Cobrahead	1	Wood	Average	4 - 8 Ft	Average	
Tioronda Avenue		121250	MV175CH-LED35CH	20	17	Blue: Mercury vapor	Cobrahead	1	Wood	Average	4 - 8 Ft	Average	
Knevels Avenue	98	41569	MV175CH-LED35CH	20	17	Blue: Mercury vapor	Cobrahead	1	Wood	Average	4 - 8 Ft	Average	No sticker
Knevels Avenue	9	121275	HP570CH-LED25CH	20	7	Yellow: Sodium vapor lamp	Cobrahead	1	Wood	Average	4 - 8 Ft	Average	No sticker
Red Flynn Drive			HP5150CH-LED72CH	30	15	Yellow: Sodium vapor lamp	Cobrahead	1	Metal	Good	8 - 12 FT	Good	
Red Flynn Drive			HP5150CH-LED72CH	30	15	Yellow: Sodium vapor lamp	Cobrahead	1	Metal	Good	4 - 8 Ft	Average	
Knevels Avenue	29	121279	MV175CH-LED35CH	20	17	Blue: Mercury vapor	Cobrahead	1	Wood	Average	4 - 8 Ft	Average	No sticker
Beekman Street		160409	HP5150CH-LED72CH	30	15	Yellow: Sodium vapor lamp	Cobrahead	1	Wood	Average	8 - 12 FT	Average	
Beekman Street			HP5250CH-LED145CH	35	25	Yellow: Sodium vapor lamp	Cobrahead	1	Metal	Good	4 - 8 Ft	Good	
Beekman Street			HP5150CH-LED72CH	30	15	Yellow: Sodium vapor lamp	Cobrahead	1	Metal	Good	4 - 8 Ft	Good	
Beekman Street			HP5250CH-LED145CH	30	25	Yellow: Sodium vapor lamp	Cobrahead	1	Metal	Good	8 - 12 FT	Good	
Beekman Street			HP5250CH-LED145CH	30	25	Yellow: Sodium vapor lamp	Cobrahead	1	Metal	Good	8 - 12 FT	Good	
Beekman Street			HP5250CH-LED145CH	30	25	Yellow: Sodium vapor lamp	Cobrahead	1	Metal	Good	8 - 12 FT	Good	
Cherry Street	361		MV175CH-LED35CH	20	17	Blue: Mercury vapor	Cobrahead	1	Wood	Average	4 - 8 Ft	Average	No sticker
Beekman Street			HP5250CH-LED145CH	30	25	Yellow: Sodium vapor lamp	Cobrahead	1	Metal	Good	8 - 12 FT	Good	
Beekman Street			HP5250CH-LED145CH	30	25	Yellow: Sodium vapor lamp	Cobrahead	1	Metal	Good	8 - 12 FT	Good	
Beekman Street		6198	HP5250CH-LED145CH	30	25	Yellow: Sodium vapor lamp	Cobrahead	1	Metal	Good	8 - 12 FT	Good	
Wolcott Avenue			HP5400PT-LED135PT	20	40	Yellow: Sodium vapor lamp	Post Top	1	Metal	Average			
Wolcott Avenue			HP5400PT-LED135PT	20	40	Yellow: Sodium vapor lamp	Post Top	1	Metal	Average			
Wolcott Avenue	1085		HP5400PT-LED135PT	20	40	Yellow: Sodium vapor lamp	Post Top	1	Metal	Average			
Wolcott Avenue			HP5400PT-LED135PT	20	40	Yellow: Sodium vapor lamp	Post Top	1	Metal	Average			
Newlins Mills Road		134536	HP570CH-LED25CH	20	7	Yellow: Sodium vapor lamp	Cobrahead	1	Wood	Average	4 - 8 Ft	Average	
Newlins Mills Road		p24966	MV175CH-LED35CH	20	17	Blue: Mercury vapor	Cobrahead	1	Wood	Average	4 - 8 Ft	Average	No sticker
Wolcott Avenue			HP5400PT-LED135PT	20	40	Yellow: Sodium vapor lamp	Post Top	1	Metal	Good			
Paye Street	24	102288	HP570CH-LED25CH	20	7	Yellow: Sodium vapor lamp	Cobrahead	1	Wood	Average	4 - 8 Ft	Average	
South Avenue	478	27113	HP570CH-LED25CH	20	7	Yellow: Sodium vapor lamp	Cobrahead	1	Wood	Average	4 - 8 Ft	Average	
South Avenue		27110	HP570CH-LED25CH	20	7	Yellow: Sodium vapor lamp	Cobrahead	1	Wood	Average	4 - 8 Ft	Average	
Wolcott Avenue		74835	HP5400PT-LED135PT	20	40	Yellow: Sodium vapor lamp	Post Top	1	Metal	Average			
Beekman Street		74841	HP5400PT-LED135PT	20	40	Yellow: Sodium vapor lamp	Post Top	1	Metal	Average			
Red Flynn Drive			MH2505B-LED1105B	15	25	Red: Metal halide	Shoe Box	2	Metal	Good			
Red Flynn Drive			MH2505B-LED1105B	15	25	Red: Metal halide	Shoe Box	2	Metal	Good			
Beekman Street			MH2505B-LED1105B	15	25	Red: Metal halide	Shoe Box	1	Metal	Good			
Beekman Street			MH2505B-LED1105B	15	25	Red: Metal halide	Shoe Box	1	Metal	Good			
Beekman Street			MH2505B-LED1105B	15	25	Red: Metal halide	Shoe Box	1	Metal	Good			
Red Flynn Drive			MH2505B-LED1105B	15	25	Red: Metal halide	Shoe Box	1	Metal	Good			
Cliff Street			HP5250CH-LED145CH	30	25	Yellow: Sodium vapor lamp	Cobrahead	1	Metal	Average	4 - 8 Ft	Average	
Beekman Street			MH2505B-LED1105B	15	25	Red: Metal halide	Shoe Box	1	Metal	Average			
		164904	HP5400FL-LED213FL	40	40	Yellow: Sodium vapor lamp	Floodlight	2	Wood	Good	0 - 4 Ft		
Knevels Avenue		41568	HP570CH-LED25CH	20	7	Yellow: Sodium vapor lamp	Cobrahead	1	Wood	Average	4 - 8 Ft	Average	
Newlins Mills Road	37	134547	HP570CH-LED25CH	20	7	Yellow: Sodium vapor lamp	Other	1	Wood	Average	0 - 4 Ft	Average	
Wolcott Avenue			HP5400PT-LED135PT	20	40	Yellow: Sodium vapor lamp	Post Top	1	Metal	Average			
Wolcott Avenue			HP5400PT-LED135PT	20	40	Yellow: Sodium vapor lamp	Post Top	1	Metal	Average			
Wolcott Avenue			HP5400PT-LED135PT	20	40	Yellow: Sodium vapor lamp	Post Top	1	Metal	Average			
Wolcott Avenue			HP5400PT-LED135PT	20	40	Yellow: Sodium vapor lamp	Post Top	1	Metal	Average			
Wolcott Avenue			HP5400PT-LED135PT	20	40	Yellow: Sodium vapor lamp	Post Top	1	Metal	Average			
Wolcott Avenue			HP5400PT-LED135PT	20	40	Yellow: Sodium vapor lamp	Post Top	1	Metal	Average			
Wolcott Avenue			HP5400PT-LED135PT	20	40	Yellow: Sodium vapor lamp	Post Top	1	Metal	Average			
Wolcott Avenue		74846	HP5400PT-LED135PT	20	40	Yellow: Sodium vapor lamp	Post Top	1	Metal	Average			Customers property zj took pic
Wolcott Avenue			HP5400PT-LED135PT	20	40	Yellow: Sodium vapor lamp	Post Top	1	Metal	Average			
Wolcott Avenue		74344	HP5400PT-LED135PT	20	40	Yellow: Sodium vapor lamp	Post Top	1	Metal	Average			
Ramp			HP5400PT-LED135PT	20	40	Yellow: Sodium vapor lamp	Post Top	1	Metal	Average			
South Avenue		69867	MV175CH-LED35CH	20	17	Blue: Mercury vapor	Cobrahead	1	Wood	Average	4 - 8 Ft	Average	No sticker
Wolcott Avenue			HP5400PT-LED135PT	20	40	Yellow: Sodium vapor lamp	Post Top	1	Metal	Average			
South Avenue	494	27113	HP570CH-LED25CH	20	7	Yellow: Sodium vapor lamp	Cobrahead	1	Wood	Average	4 - 8 Ft	Average	
South Avenue	482	27116	HP570CH-LED25CH	20	7	Yellow: Sodium vapor lamp	Cobrahead	1	Wood	Average	4 - 8 Ft	Average	
South Avenue		27107	HP5150CH-LED72CH	20	15	Yellow: Sodium vapor lamp	Cobrahead	1	Wood	Average	4 - 8 Ft	Average	
Beekman Street			HP5400PT-LED135PT	20	40	Yellow: Sodium vapor lamp	Post Top	1	Metal	Average			
Wolcott Avenue			HP5400PT-LED135PT	20	40	Yellow: Sodium vapor lamp	Post Top	1	Metal	Average			
Wolcott Avenue			HP5400PT-LED135PT	20	40	Yellow: Sodium vapor lamp	Post Top	1	Metal	Average			
Wolcott Avenue			HP5400PT-LED135PT	20	40	Yellow: Sodium vapor lamp	Post Top	1	Metal	Average			
Wolcott Avenue			HP5400PT-LED135PT	20	40	Yellow: Sodium vapor lamp	Post Top	1	Metal	Average			
Wolcott Avenue			HP5400PT-LED135PT	20	40	Yellow: Sodium vapor lamp	Post Top	1	Metal	Average			
Beekman Street			HP5400PT-LED135PT	20	40	Yellow: Sodium vapor lamp	Post Top	1	Metal	Average			
Beekman Street			HP5400PT-LED135PT	20	40	Yellow: Sodium vapor lamp	Post Top	1	Metal	Average			
Beekman Street		141977	HP5250CH-LED145CH	30	25	Yellow: Sodium vapor lamp	Cobrahead	1	Wood	Average	4 - 8 Ft	Average	
Beekman Street		125665	HP5150CH-LED72CH	30	15	Yellow: Sodium vapor lamp	Cobrahead	1	Wood	Average	4 - 8 Ft	Average	
Beekman Street			MH2505B-LED1105B	15	25	Red: Metal halide	Shoe Box	1	Metal	Good			
Beekman Street			MH2505B-LED1105B	15	25	Red: Metal halide	Shoe Box	1	Metal	Good			
Beekman Street			MH2505B-LED1105B	15	25	Red: Metal halide	Shoe Box	1	Metal	Good			
Beekman Street			MH2505B-LED1105B	15	25	Red: Metal halide	Shoe Box	1	Metal	Good			
Beekman Street			MH2505B-LED1105B	15	25	Red: Metal halide	Shoe Box	1	Metal	Good			
Beekman Street			MH2505B-LED1105B	15	25	Red: Metal halide	Shoe Box	1	Metal	Good			
Daliss Place				20		Other		1	Wood	Average	0 - 4 Ft	Average	Barn light type fixture
Beekman Street			MH2505B-LED1105B	15	25	Red: Metal halide	Shoe Box	1	Metal	Good			
Cliff Street			HP5250CH-LED145CH	30	25	Yellow: Sodium vapor lamp	Cobrahead	1	Metal	Average	4 - 8 Ft	Average	
			HP5400FL-LED213FL	30	40	Yellow: Sodium vapor lamp	Floodlight	2	Wood	Good	0 - 4 Ft		

City of Beacon

Traffic Signals

<u>Location</u>	<u>Faces</u>
Willow St. & Verplanck Ave.	4
Blackburn & Fishkill Aves.	3
East Main & Main Sts.	4
Bank Square	4
Main St. & Teller Ave.	4
Fishkill & Verplanck Aves.	4
Wolcott & Howland Aves.	2
North Ave. & Verplanck Ave.	5
Fishkill Ave. & DeLavan Ave.	7
Fishkill Ave. & Mill St.	5
South, Wolcott & Dennis Aves.	12
Route 9D/Verplanck Avenue	18
Route 9D/Main Street	14
Wolcott Ave & Tiboranda Ave	26

3/25/99

Total Faces 86 @ \$1.08 per Face = \$92.88

112

120.96

Group 7651  
Folio 0800-00  
wpC5:6





City of Beacon

Traffic Signals

<u>Location</u>	<u>Faces</u>
Willow St. & Verplanck Ave.	4
Blackburn & Fishkill Aves.	3
East Main & Main Sts.	4
Bank Square	4
Main St. & Teller Ave.	4
Fishkill & Verplanck Aves.	4
Wolcott & Howland Aves.	2
North Ave. & Verplanck Ave.	5
Fishkill Ave. & DeLavan Ave.	7
Fishkill Ave. & Mill St.	5
South, Wolcott & Dennis Aves.	12
Route 9D/Verplanck Avenue	18
Route 9D/Main Street	14
Wolcott Ave & Tiboranda Ave	26

3/25/99

Total Faces 86 @ \$1.08 per Face = \$92.88

112

120.96

Group 7651  
Folio 0800-00  
wpC5:6







**PHILIPS**  
**GARDCO**

Floodlights

ClearScape

Medium, CSFM



Project: \_\_\_\_\_

Location: \_\_\_\_\_

Cat.No: \_\_\_\_\_

Type: \_\_\_\_\_

Quantity: \_\_\_\_\_

Notes: \_\_\_\_\_

The Philips Gardco ClearScape LED luminaires feature an architecturally stylish design that will complement your application's visual landscape. ClearScape offers unparalleled photometric performance, significant savings over HID, and is available with the latest in energy saving control options.

**Ordering guide**

Example: CSFM-64L-1A-NW-G1-SF-SP-UNIV-BK

Prefix	# of LEDs	Drive Current	LED Color	Generation	Mounting	Distribution	Voltage	Options	Finish	
<input type="text"/>	<input type="text"/>	<input type="text"/>	<input type="text"/>	<b>G1</b>	<input type="text"/>	<input type="text"/>	<input type="text"/>	<input type="text"/>	<input type="text"/>	
<b>CSFM</b> ClearScape Flood Medium	<b>48L</b> 48 LEDs     <b>64L</b> 64 LEDs	<b>530</b> 530 mA <b>700</b> 700 mA    <b>700</b> 700 mA <b>1A</b> 1000 mA	<b>NW</b> Neutral White 4,000K, 70 min. CRI  <b>CW</b> Cool White 5,700K, 70 min. CRI  <b>WW</b> Warm White 3,000K, 70 min. CRI  <b>TW</b> <sup>1</sup> Tunable White  <i>'TW' is field adjustable from 3,500K to 5,500K in (6) 400K increments. Provides an output of approximately 12,000 lumens across all color temperatures.</i>	<b>G1</b> Gen-1	<b>SF</b> Slip Fitter Mount (fits to 2-3/8" O.D. tenon)  <b>YK</b> Yoke Mount	<b>SP</b> Spot  <b>RSP</b> Rectangular Spot  <b>A33</b> Asymmetric 33° Flood  <b>RN</b> Rectangular Narrow Flood  <b>RM</b> Rectangular Medium Flood	<b>120</b> <b>208</b> <b>240</b> <b>277</b> <b>347</b> <b>480</b> <sup>7</sup> <b>UNV</b> <sup>6</sup> (120-277V) <b>HVU</b> <sup>6</sup> (347-480V)	<b>DD</b> <sup>2</sup> 0-10V Dimming Driver  DynaDimmer Safety Profile <b>DS25</b> <sup>3</sup> <b>DS50</b> <sup>3</sup> <b>DS75</b> <sup>3</sup>  DynaDimmer Median Profile <b>DM25</b> <sup>3</sup> <b>DM50</b> <sup>3</sup> <b>DM75</b> <sup>3</sup>  DynaDimmer Economy Profile <b>DE25</b> <sup>3</sup> <b>DE50</b> <sup>3</sup> <b>DE75</b> <sup>3</sup>  <b>MRO</b> <sup>4,5,14</sup> DynaDimmer and Motion Response Override <i>Pole Mounted sensor</i>  <b>MR50</b> <sup>5,14</sup> Motion Response (50% Low) <i>Pole Mounted sensor</i>	<b>PCB</b> <sup>6,7</sup> Photocontrol Button  <b>TLR</b> <sup>10</sup> Twist Lock Receptacle  <b>TLRPC</b> <sup>6,8,10</sup> Twist Lock Receptacle w/ Photocell  <b>F1</b> <sup>6</sup> Single Fusing (120, 277, 347V)  <b>F2</b> <sup>6</sup> Double Fusing (208, 240, 480V)  <b>F3</b> <sup>6</sup> Double Fusing Canadian Double Pull (208, 240, 480V)  <b>ICL</b> <sup>9</sup> Internal Concentric Glare Louver	<b>BK</b> Textured Black  <b>WH</b> Textured White  <b>BZ</b> Textured Dark Bronze  <b>DGY</b> Textured Dark Gray  <b>MGY</b> Textured Medium Gray  <b>OC</b> Optional Color Specify optional color or RAL ex: OC-LGP or OC-RAL7024.  <b>SC</b> Special Color Specify. Must supply color chip. Requires factory quote.

1. 'TW' only available with 'CSFM-64L-1A' units.  
2. 0-10V leads exiting the luminaire are supplied for secondary controls (by others).  
3. DynaDimmer available with 120 through 277V only.  
4. DynaDimmer Profile must be specified with 'MRO' option. Example: DE75-MRO  
5. Requires 'MS-A-120' or 'MS-A-277' Accessory (ordered separately) . 120 or 277V only. Pole Mounted Sensor  
6. Specify input voltage. Fusing and Photocontrols are not available with 'UNV' or 'HVU' options.  
7. 'PCB' option is not available in 480V.  
8. Not available with 347 or 480V.  
9. Not available with Spot Optics (SP).  
10. Not available with Yoke Mount.

# CSFM ClearScape LED Floodlight, Medium

48 or 64 LED

Accessories - Ordering guide (Must be ordered separately)

Shielding and Lenses	Mounting - Slipfitter Mount	Mounting - Yoke Mount	Motion Response
<p><b>ICL-CSFM(48/64)<sup>11</sup></b> Internal Concentric Glare Louvers</p> <p><b>BD-CSFM<sup>12</sup></b> Barn Doors (Black finish standard)</p> <p><b>WG-CSFM</b> Wire Guard</p> <p><b>SG-CSFM</b> Stone Guard</p> <p><b>RDF-CSFM<sup>12</sup></b> Red Color Filter</p> <p><b>PKF-CSFM<sup>12</sup></b> Pink Color Filter</p> <p><b>BLF-CSFM<sup>12</sup></b> Blue Color Filter</p> <p><b>GNF-CSFM<sup>12</sup></b> Green Color Filter</p>	<p><b>WMB-16.5-(F)<sup>13</sup></b> Wall Mounting Bracket</p> <p><b>SMT-2-(F)<sup>13</sup></b> Surface Mount Tenon</p> <p><b>JB-VMT-(F)<sup>13</sup></b> Junction Box w/ SMT-2</p> <p><b>SM-18-(F)<sup>13</sup></b> 18" Stanchion Mount</p> <p><b>PTA-2180-16.5-(F)<sup>13</sup></b> Pole Top Adaptor 2@180</p> <p><b>PTA-2090-16.5-(F)<sup>13</sup></b> Pole Top Adaptor 2@90</p> <p><b>PTA-3090-16.5-(F)<sup>13</sup></b> Pole Top Adaptor 3@90</p> <p><b>PTA-4090-16.5-(F)<sup>13</sup></b> Pole Top Adaptor 4@90</p>	<p><b>MF4-(F)<sup>13</sup></b> Standalone Slip Fitter</p> <p><b>BP-(F)<sup>13</sup></b> Surface Mount Base Plate</p> <p><b>JB-BP-(F)<sup>13</sup></b> Junction Box w/ Base Plate</p>	<p><b>MS-A-120V<sup>5,14</sup></b> 120V input - Motion Sensor for MR50 or MRO (pole mount only)</p> <p><b>MS-A-277V<sup>5,14</sup></b> 277V input - Motion Sensor for MR50 or MRO (pole mount only)</p>

11. (48/64) = Specify LED count Example: CSFS48

13. (F) = Specify Finish

12. Color filters and Barn Doors available Q2, 2015.

14. Requires 'MR50' option or DynaDimmer 'MRO' option to be specified with the luminaire.

## Dimensions - ClearScape Medium (CSFM)

### Slipfitter Mount

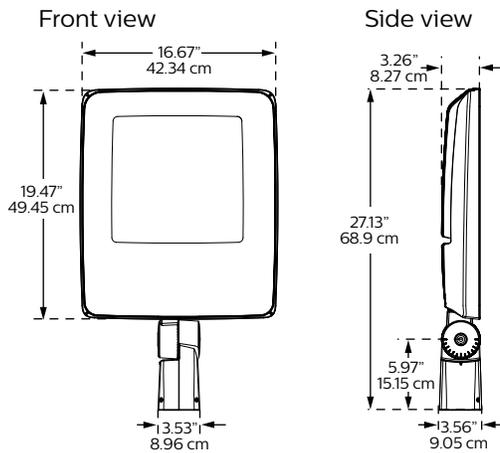

Weight: 41 Lbs  
EPA: 2.80 ft<sup>2</sup>

### Yoke Mount

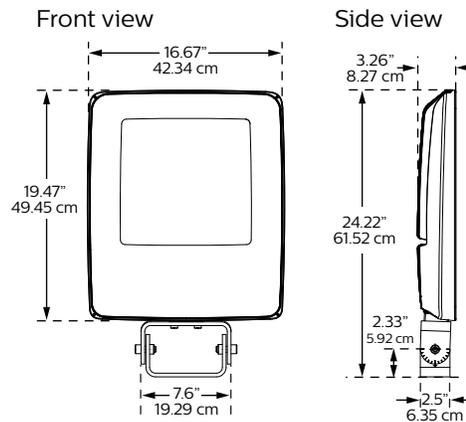

Weight: 39 Lbs  
EPA: 2.68 ft<sup>2</sup>

### Slipfitter Aiming Diagram

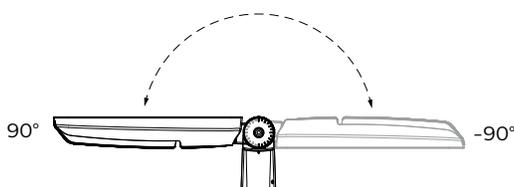

### Drill Template - Yoke Mount

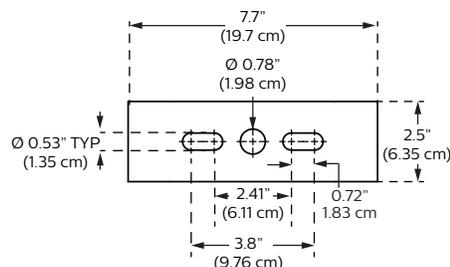

Recommended Bolt Size: 1/2"

# CSFM ClearScape LED Floodlight, Medium

48 or 64 LED

## Distribution Patterns



**Spot 'SP'**

50% Main Beam: 15°H x 15°V  
 10% Field Beam: 24°H x 24°V  
 20' Setback, 0° Tilt

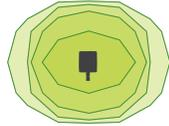

**Rectangular Spot 'RSP'**

50% Main Beam: 22°H x 13°V  
 10% Field Beam: 40°H x 30°V  
 20' Setback, 0° Tilt

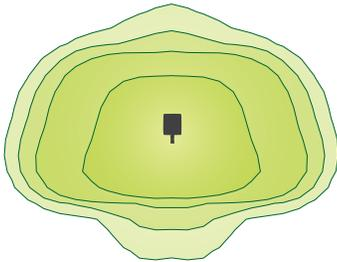

**Asymmetric 33° Flood 'A33'**

50% Main Beam: 81°H x 38°V  
 10% Field Beam: 119°H x 77°V  
 20' Setback, 0° Tilt

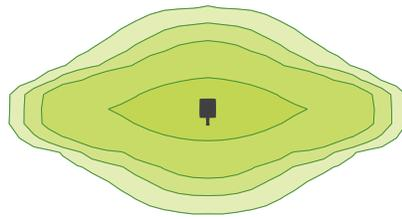

**Rectangular Narrow 'RN'**

50% Main Beam: 138°H x 41°V  
 10% Field Beam: 148°H x 75°V  
 20' Setback, 0° Tilt

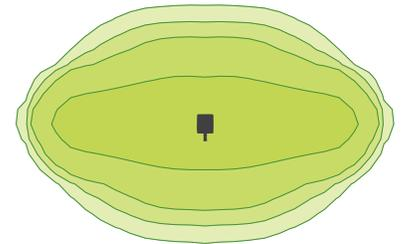

**Rectangular Medium 'RM'**

50% Main Beam: 81°H x 39°V  
 10% Field Beam: 119°H x 77°V  
 20' Setback, 0° Tilt

## Technical Data

Order Code	# of LEDs	LED Current (mA)	Color Temperature (CCT)	Average System Wattage (W)	Initial Nominal Delivered Lumens					Average Efficacy (Lm/W)
					SP	RSP	A33	RN	RM	
CSFM-48L-530-NW	48	530	4000K, NW	80	9,539	9,259	9,372	9,186	9,374	119
CSFM-48L-700-NW	48	700	4000K, NW	106	11,871	11,522	11,707	11,432	11,666	113
CSFM-64L-700-NW	64	700	4000K, NW	144	15,898	15,432	15,550	15,311	15,624	110
CSFM-64L-1A-NW	64	1,050	4000K, NW	213	21,198	20,575	20,864	20,413	20,832	100
CSFM-64L-1A-TW	64	1,050	TW	112	12,175					109

**Notes:**

Due to rapid and continuous advances in LED technology, LED luminaire data is subject to change without notice and at the discretion of Philips. Lumen output by optic type will vary slightly. See IES files and specification sheets when available. All technical data is subject to change.



# CSFM ClearScape LED Floodlight, Medium

48 or 64 LED

## Luminaire Option and Accessory details

Barn Doors (BD)

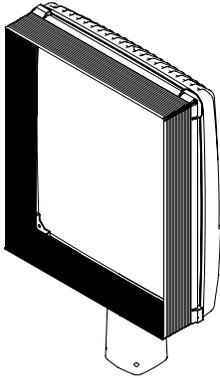

Stone Guard (SG)

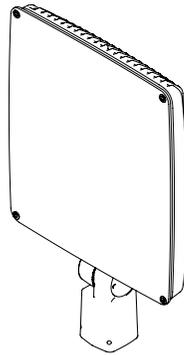

Wire Guard (WG)

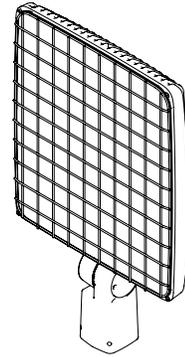

## Control option details

### MR50

#### Motion Response

Philips Gardco ClearScape LED luminaire with motion response, providing a 50% power reduction on low and a commensurate reduction in light output. The power and light output reduction is accomplished utilizing the Philips DynaDimmer module, programmed for a constant 50% power. Power supplied by the motion sensor connected to the override line on the DynaDimmer takes the luminaire to high setting, 100% power and light output, when motion is detected. The luminaire remains on high until no motion is detected for the motion sensor duration period, after which the luminaire returns to low. Duration period is factory set at 15 minutes, and is field adjustable from 5 minutes up to 15 minutes.

MR50 is available in 120V through 277V input only to the luminaire.

Motion sensors require single voltage 120V or 277V input.

The Area PIR motion sensor is the WattStopper EW-200-120-W (120V Input - MSA-120V) or the WattStopper EW-200-277-W (277V Input - MSA-277V.) One motion sensor per pole is required and is ordered separately. Area sensors require single voltage 120V or 277V input.

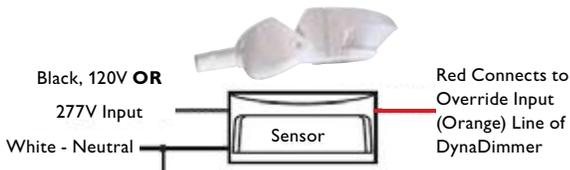

The area motion detector provides coverage equal to up to 6 times the sensor height above ground, 270° from the front-center of the sensor.

Area PIR Motion Sensor Coverage Pattern:

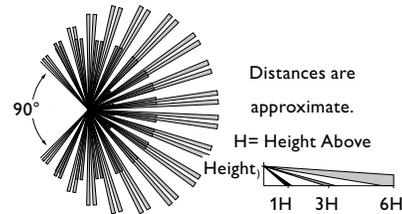

Motion response requires that the pole include an additional hand hole 15 feet above the pole base, normally oriented 180° to the standard hand hole. For Philips Gardco poles, order the pole with the Motion Sensor Mounting (MSM) option which includes the hand hole and a special hand hole cover plate for the sensor with a 1/2" NPT receptacle centered on the hand hole cover plate into which the motion sensor mounts. Once the motion sensor is connected to the hand hole cover plate, then wiring connections are completed in the pole. The plate (complete with motion sensor attached and wired) is then mounted to the hand hole. If poles are supplied by others, the customer is responsible for providing suitable mounting accommodations for the motion sensor in the pole.

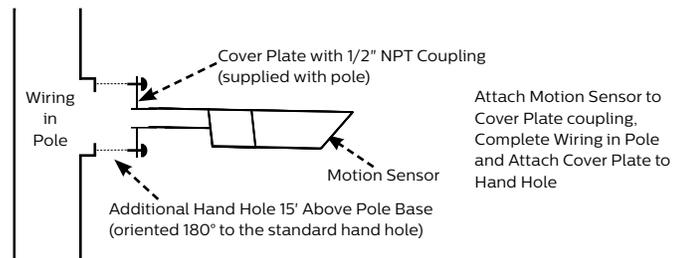

# CSFM ClearScape LED Floodlight, Medium

48 or 64 LED

## Mounting accessory details - Slipfitter

### WMB-16.5-(F)

Wall Mounting Bracket

2-3/8" O.D. vertical tenon welded to extruded aluminum arm with removable end cap for wiring. Arm is bolted to a cast aluminum plate that has four 5/8" diameter mounting holes.

Suitable for mounting single luminaire only.

Mounting hardware by others.

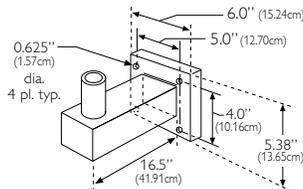

### SMT-2-(F)

Surface Mounted Tenon

2-3/8" O.D. aluminum tenon welded to a flat aluminum plate with four 1/2" diameter mounting holes.

Single floodlight may be pad mounted or wall mounted.

Mounting hardware by others.

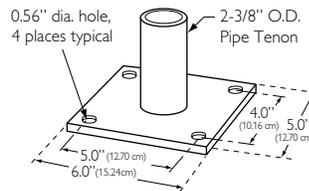

### JB-VMT-(F)

Junction Box with SMT-2

For mounting to flat surfaces when using surface mount conduit.

Box has four 1/2" pipe entrances.

1/2" NPS.

Mounting hardware by others.

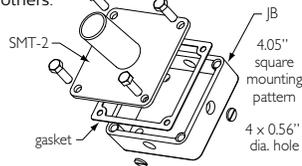

### SM-18-(F)

18" Stanchion Mount

Stanchion mounting allows stable positioning of vertical tenon member in aggregate or substrate.

2-3/8" O.D. aluminum tenon welded to a 2-7/8" stanchion.

Standard length: 18"

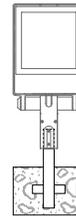

### PTA-2180-16.5-(F)

Pole Top Adapter, 2@180

Vertically mounted 2-3/8" O.D. tenons welded to extruded aluminum arms with removable end cap for wiring. Arms bolted to cast aluminum pole top bracket. Fits poles having a 2-3/8" O.D. x 4" vertical tenon.

### PTA-2090-16.5-(F)

Pole Top Adapter, 2@90

Components shipped separately. Field assembly required.

### PTA-3090-16.5-(F)

Pole Top Adapter, 3@90

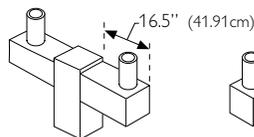

additional EPA: 0.75  
2 @ 180

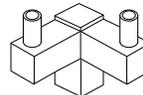

additional EPA: 1.2  
2 @ 90

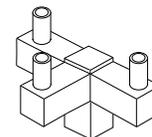

additional EPA: 1.0  
3 @ 90

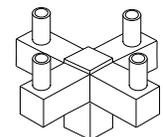

additional EPA: 1.5  
4 @ 90

### PTA-4090-16.5-(F)

Pole Top Adapter, 4@90

## Mounting accessory details - Yoke Mount

### MF4-(F) Slip Fitter

Fits 2-3/8" O.D. tenon

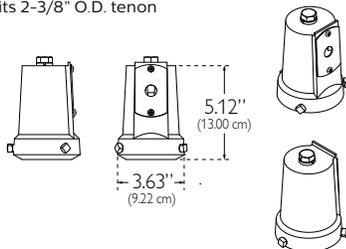

### BP-(F) Surface Mount Base Plate

Flat aluminum plate with four 1/2" diameter mounting holes. Single floodlight may be pad mounted or wall mounted. Mounting hardware by others.

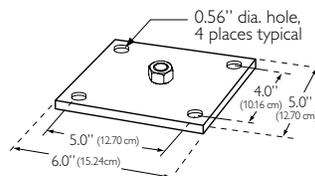

### JB-BP-(F) Junction Box with BP

For mounting to flat surfaces when using surface mount conduit. Box has four 1/2" pipe entrances. Mounting hardware by others. 1/2" NPS.

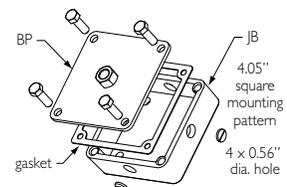

# CSFM ClearScape LED Floodlight, Medium

48 or 64 LED

## Specifications

### Construction

Die-cast aluminum housing with corrosion resistant hardware. ClearScape housing constructed to IP66. Die-cast aluminum heatsink allows for long life of LEDs up to 40°C ambient.

### Thermal Management

The luminaire design incorporates vertical fins that allow the housing to provide excellent thermal management critical to long LED system life.

### LED Board and Array

48 or 64 high power LEDs. Warm, Neutral, and Cool Color temperatures available. Metal core printed circuit board. RoHS compliant.

### IP Rating

Luminaire optic and electrical housing constructed to IP66.

### Driver

High efficiency multi-volt driver (50 or 60 Hz), maintains constant current flow to LEDs to accommodate LED variations. High power factor (0.9 standard). Constant current: 530, 700, or 1000 mA. Voltage: 120-277, 347, 480. Ambient temperature range: -40°C (-40°F) to 40°C (104°F). Open / short circuit protection. RoHS compliant. Surge protector standard. The surge protector is in accordance with IEEE / ANSI C62.41.2 guidelines, with a surge current rating of 10 KV / 5 KA.

### LED Optical System

SP - Spot, RSP - Rectangular Spot, A33 - Asymmetric 33° Flood, RN - Rectangular Narrow Flood, RM - Rectangular Medium Flood distributions. See optical data for details. Fully gasketed IP66-rated construction.

### Optical Options

Internal Concentric Glare Louver (ICL) options reduce glare and increase visual comfort. Shields are mounted internally, and do not disrupt the overall aesthetic of the luminaire. Shields can be ordered as an option and installed in the factory, or as an accessory for field installation.

Barn doors are also available.

### Mounting

Slipfitter (SF) is vertically adjustable, suitable for mounting to a 2-3/8" O.D. tenon. Slipfitter features an integral splice compartment with gasketed access cover to eliminate the need for a secondary junction box.

Yoke mount also available

### Tunable White

Tunable White (TW) is field adjustable from 3500K to 5500K in (6) 400K increments. Provides an output of approximately 12,000 lumens across all color temperatures.

### Vibration Resistance

ClearScape with yoke mount and slipfitter carries a 3G vibration rating that conforms to the standards set forth by ANSI C136.31. Testing includes vibration to 3G acceleration in three axes, all performed on the same luminaire.

### Energy saving benefits and controls

The CSFM has a system efficacy of up to 119 LPW at a system wattage of up to 213W. ClearScape provides a minimum of 54% energy savings over traditional HID systems without controls. Optional DynaDimmer and motion response controls provide additional energy savings by dimming to 25%.

### Finish

Standard textured finishes available. BZ - Textured Dark Bronze, DGY - Textured Dark Gray, MGY - Textured Medium Gray, WH - Textured White, BK - Textured Black.

### Accessories

See ordering guide on page 2, 4 and 5 for details.

### Listings

All luminaires bear UL or cUL (where applicable) Wet Location labels. Suitable for use in ambients from -40° to 40°C (-40° to 104°F).

### Limited Warranty

5 year limited warranty. See philips.com/luminaires for complete details and exclusions.

## LED Performance:

PREDICTED LUMEN DEPRECIATION DATA <sup>14</sup>				
Ambient Temperature °C	Driver mA	Calculated L <sub>70</sub> Hours <sup>14,15</sup>	L <sub>70</sub> Per TM-21 <sup>15,16</sup>	Lumen Maintenance % @ 60,000 hours
25°C	up to 1050 mA	>100,000	>60,000	96%

14. Predicted performance derived from LED manufacturer's data and engineering design estimates, based on IESNA LM-80 methodology. Actual experience may vary due to field application conditions.

15. L<sub>70</sub> is the predicted time when LED performance depreciates to 70% of initial lumen output.

16. Calculated per IESNA TM21-11. Published L<sub>70</sub> hours limited to 6 times actual LED test hours.

© 2014 Koninklijke Philips N.V. All rights reserved. Philips reserves the right to make changes in specifications and/or to discontinue any product at any time without notice or obligation and will not be liable for any consequences resulting from the use of this publication. philips.com/luminaires



Philips Lighting, North America Corporation  
200 Franklin Square Drive, Somerset, NJ 08873  
Tel. 855-486-2216

Imported by: Philips Lighting,  
A division of Philips Electronics Ltd.  
281 Hillmount Rd, Markham, ON, Canada L6C 2S3  
Tel. 800-668-9008



# DOMUS

## SERIES

Product Overview and Technical information >>



>>  
LUMINAIRE > DMS50-SG  
BRACKET > PC-1A  
POLE > SPR4-LBC4





LEDGINE



Some luminaires of this series are IDA (International Dark-Sky Association) approved.



DMS60-SHA

DMS50-SG-LM

DMS50-SHA-NM

DMS50-SG-LD-MM

# DOMUS SERIES

**Designed Equilibrium** / The Domus Series of products – Domus, Domus 55, and Domus Small - are all designed to complement each other and bring balance to any environment. Their charm is undeniable. Simplicity, refinement, and elegance, all fuse together to create harmonious beauty through designed equilibrium. >>





>>  
LUMINAIRE > DMS50-SG  
BRACKET > MM-1A  
POLE > AM6

## ELEGANT DESIGN

**The Domus Series is one of the most versatile luminaires offered by Philips Lumec.** This classic shape was one of the first in a line of pioneering Philips Lumec designs. Encompassing most of the exclusive Philips Lumec innovations, the Domus can fit into any environment; be it the main street of a small Alaskan village or the downtown of a high-tech center. Combined with today's efficient optics, Domus embodies the tradition of excellence in Philips Lumec products.

## PRACTICAL TECHNOLOGY

**Harmonizing beautifully with virtually any urban setting, the Domus Series luminaires are representative of the new generation of lighting units.** Constructed from top-quality materials, the Domus Series maintains excellent performance in even the most demanding environments. The Smartseal™ optical systems (IP66) of the Domus virtually eliminate Luminaire Dirt Depreciation (LDD), while the toolfree access to the lamp and electrical components make maintenance a breeze. >>



# BENEFITS

- Constructed from top-quality materials, the Domus Series maintains excellent performance in even the most demanding environments.
- Can be powered by the LifeLED™, Philips Lumec's state-of-the-art, energy-efficient LED light engine.
- SHA and SSA optical chambers reduce glare by using a unique combination of reflectors and internal prism refractors.
- SCB optical chamber offers exceptional performance and cut-off with a combination of a hydro-formed aluminum reflector and a tempered glass lens.
- Dark-sky friendly SG optics provide full cut-off in five distributions.

# LUMINAIRES

Conform to the UL 1598 and CSA C22.2 No. 250.0-08 standards

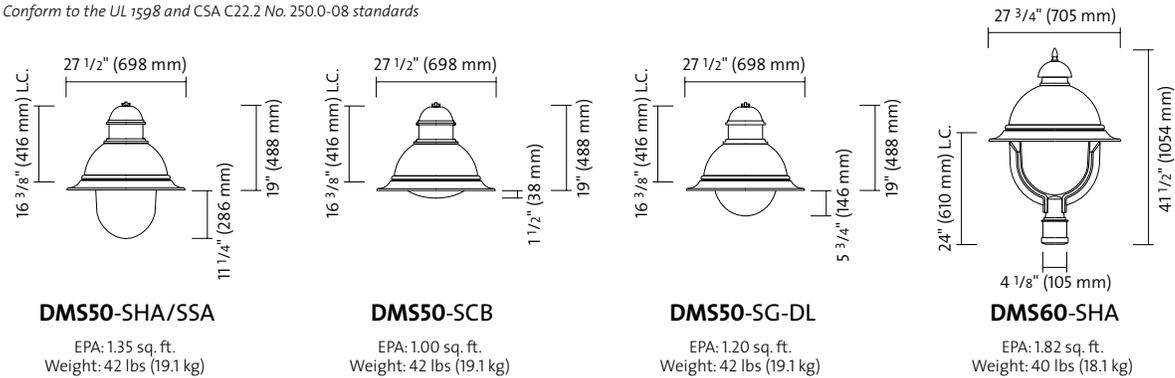

# LAMPS / LED

LED = Philips Lumileds Luxeon R, CRI = 70, CCT = 4000K (+/- 350K)

System (LED + driver) Rated life = 100,000 hrs<sup>1</sup>

## LED light engine technical information for DMS50 WITH FLAT LENS

LAMP	TYPICAL DELIVERED LUMENS	TYPICAL SYSTEM WATTAGE <sup>2</sup> (W)	TYPICAL CURRENT @ 120V (A)	TYPICAL CURRENT @ 208V (A)	TYPICAL CURRENT @ 240V (A)	TYPICAL CURRENT @ 277V (A)	LED CURRENT (mA)	HID EQUIVALENT <sup>3</sup>	LUMINAIRE EFFICACY RATING (LM/W)	BUG RATING
35W32LED4K-R-LE2F	3678	35	0.29	0.17	0.16	0.15	350	70-100	105.1	B1-U0-G1
35W32LED4K-R-LE3F	3859	35	0.29	0.17	0.16	0.15	350	70-100	110.2	B1-U0-G1
35W32LED4K-R-LE4F	3578	35	0.29	0.17	0.16	0.15	350	70-100	102.2	B1-U0-G1
35W32LED4K-R-LE5F	3552	35	0.29	0.17	0.16	0.15	350	70-100	101.5	B2-U0-G1
55W32LED4K-R-LE2F	5141	52	0.40	0.23	0.21	0.19	530	100-150	98.9	B1-U0-G1
55W32LED4K-R-LE3F	5404	52	0.40	0.23	0.21	0.19	530	100-150	103.9	B2-U0-G1
55W32LED4K-R-LE4F	5002	52	0.40	0.23	0.21	0.19	530	100-150	96.2	B1-U0-G1
55W32LED4K-R-LE5F	4966	52	0.40	0.23	0.21	0.19	530	100-150	95.5	B3-U0-G1
55W48LED4K-R-LE2F	5301	55	0.38	0.22	0.23	0.21	350	100-150	96.4	B1-U0-G1
55W48LED4K-R-LE3F	5566	55	0.38	0.22	0.23	0.21	350	100-150	101.2	B2-U0-G1
55W48LED4K-R-LE4F	5158	55	0.38	0.22	0.23	0.21	350	100-150	93.8	B1-U0-G1
55W48LED4K-R-LE5F	5120	55	0.38	0.22	0.23	0.21	350	100-150	93.1	B3-U0-G1
80W48LED4K-R-LE2F	7454	79	0.63	0.36	0.34	0.31	530	150-175	94.3	B2-U0-G1
80W48LED4K-R-LE3F	7833	79	0.63	0.36	0.34	0.31	530	150-175	99.2	B2-U0-G2
80W48LED4K-R-LE4F	7252	79	0.63	0.36	0.34	0.31	530	150-175	91.8	B2-U0-G2
80W48LED4K-R-LE5F	7200	79	0.63	0.36	0.34	0.31	530	150-175	91.1	B3-U0-G1
70W64LED4K-R-LE2F	7478	71	0.58	0.34	0.32	0.3	350	100-150	105.3	B2-U0-G1
70W64LED4K-R-LE3F	7849	71	0.58	0.34	0.32	0.3	350	100-150	110.6	B2-U0-G2
70W64LED4K-R-LE4F	7276	71	0.58	0.34	0.32	0.3	350	100-150	102.5	B2-U0-G2
70W64LED4K-R-LE5F	7223	71	0.58	0.34	0.32	0.3	350	100-150	101.7	B3-U0-G1
110W64LED4K-R-LE2F	10565	103	0.8	0.46	0.42	0.38	530	175-200	102.6	B2-U0-G2
110W64LED4K-R-LE3F	11097	103	0.8	0.46	0.42	0.38	530	175-200	107.7	B3-U0-G2
110W64LED4K-R-LE4F	10279	103	0.8	0.46	0.42	0.38	530	175-200	99.8	B2-U0-G2
110W64LED4K-R-LE5F	10206	103	0.8	0.46	0.42	0.38	530	175-200	99.1	B3-U0-G2
90W80LED4K-R-LE2F	9163	87	0.78	0.43	0.40	0.34	350	150-175	105.3	B2-U0-G2
90W80LED4K-R-LE3F	9626	87	0.78	0.43	0.40	0.34	350	150-175	110.6	B3-U0-G2
90W80LED4K-R-LE4F	8915	87	0.78	0.43	0.40	0.34	350	150-175	102.5	B2-U0-G2
90W80LED4K-R-LE5F	8851	87	0.78	0.43	0.40	0.34	350	150-175	101.7	B3-U0-G2
135W80LED4K-R-LE2F	12894	129	1.15	0.61	0.58	0.5	530	250-320	100.0	B3-U0-G2
135W80LED4K-R-LE3F	13544	129	1.15	0.61	0.58	0.5	530	250-320	105.0	B3-U0-G2
135W80LED4K-R-LE4F	12545	129	1.15	0.61	0.58	0.5	530	250-320	97.2	B3-U0-G2
135W80LED4K-R-LE5F	12454	129	1.15	0.61	0.58	0.5	530	250-320	96.5	B4-U0-G2

<sup>1</sup> L70 = 100,000 HRS (AT AMBIENT TEMPERATURE = 25°C AND FORWARD CURRENT = 700 mA)

<sup>2</sup> SYSTEM WATTAGE INCLUDES THE LAMP AND THE LED DRIVER.

<sup>3</sup> EQUIVALENCY SHOULD ALWAYS BE CONFIRMED BY A PHOTOMETRIC LAYOUT.

NOTE : DUE TO RAPID AND CONTINUOUS ADVANCES IN LED TECHNOLOGY, LED LUMINAIRE DATA IS SUBJECT TO CHANGE WITHOUT NOTICE AND AT THE DISCRETION OF PHILIPS.

Philips Lumec reserves the right to substitute materials or change the manufacturing process of its products without prior notification.

For the latest updates go to [WWW.PHILIPS.COM/LUMEC](http://WWW.PHILIPS.COM/LUMEC).

# LAMPS / LED

LED = Philips Lumileds Luxeon R, CRI = 70, CCT = 4000K (+/- 350K)

System (LED + driver) Rated life = 100,000 hrs<sup>1</sup>

## LED light engine technical information for DMS50 WITH PRISMATIC GLOBE

LAMP	TYPICAL DELIVERED LUMENS	TYPICAL SYSTEM WATTAGE <sup>2</sup> (W)	TYPICAL CURRENT @ 120V (A)	TYPICAL CURRENT @ 208V (A)	TYPICAL CURRENT @ 240V (A)	TYPICAL CURRENT @ 277V (A)	LED CURRENT (mA)	HID EQUIVALENT <sup>3</sup>	LUMINAIRE EFFICACY RATING (LM/W)	BUG RATING
35W32LED4K-R-LE2A	3694	35	0.29	0.17	0.16	0.15	350	70 -100	105.5	B1-U2-G1
35W32LED4K-R-LE3A	3918	35	0.29	0.17	0.16	0.15	350	70 -100	111.9	B1-U2-G1
35W32LED4K-R-LE4A	3693	35	0.29	0.17	0.16	0.15	350	70 -100	105.5	B1-U2-G1
55W32LED4K-R-LE2A	5164	52	0.40	0.23	0.21	0.19	530	100 -150	99.3	B1-U3-G1
55W32LED4K-R-LE3A	5478	52	0.40	0.23	0.21	0.19	530	100 -150	105.3	B2-U2-G2
55W32LED4K-R-LE4A	5163	52	0.40	0.23	0.21	0.19	530	100 -150	99.3	B1-U3-G2
55W48LED4K-R-LE2A	5325	55	0.38	0.22	0.23	0.21	350	100 -150	96.8	B1-U3-G1
55W48LED4K-R-LE3A	5648	55	0.38	0.22	0.23	0.21	350	100 -150	102.7	B2-U3-G2
55W48LED4K-R-LE4A	5324	55	0.38	0.22	0.23	0.21	350	100 -150	96.8	B1-U3-G2
80W48LED4K-R-LE2A	7486	79	0.63	0.36	0.34	0.31	530	150 -175	94.8	B2-U3-G2
80W48LED4K-R-LE3A	7941	79	0.63	0.36	0.34	0.31	530	150 -175	100.5	B2-U3-G2
80W48LED4K-R-LE4A	7486	79	0.63	0.36	0.34	0.31	530	150 -175	94.8	B2-U3-G2
70W64LED4K-R-LE2A	7511	71	0.58	0.34	0.32	0.3	350	100 -150	105.8	B2-U3-G2
70W64LED4K-R-LE3A	7967	71	0.58	0.34	0.32	0.3	350	100 -150	112.2	B2-U3-G2
70W64LED4K-R-LE4A	7510	71	0.58	0.34	0.32	0.3	350	100 -150	105.8	B2-U3-G2
110W64LED4K-R-LE2A	10612	103	0.8	0.46	0.42	0.38	530	175 -200	103.0	B2-U3-G2
110W64LED4K-R-LE3A	11256	103	0.8	0.46	0.42	0.38	530	175 -200	109.3	B3-U3-G3
110W64LED4K-R-LE4A	10611	103	0.8	0.46	0.42	0.38	530	175 -200	103.0	B2-U3-G2
90W80LED4K-R-LE2A	9204	87	0.78	0.43	0.40	0.34	350	150 -175	105.8	B2-U3-G2
90W80LED4K-R-LE3A	9763	87	0.78	0.43	0.40	0.34	350	150 -175	112.2	B2-U3-G2
90W80LED4K-R-LE4A	9203	87	0.78	0.43	0.40	0.34	350	150 -175	105.8	B2-U3-G2
135W80LED4K-R-LE2A	12950	129	1.15	0.61	0.58	0.5	530	250 -320	100.4	B3-U3-G3
135W80LED4K-R-LE3A	13737	129	1.15	0.61	0.58	0.5	530	250 -320	106.5	B3-U3-G3
135W80LED4K-R-LE4A	12949	129	1.15	0.61	0.58	0.5	530	250 -320	100.4	B2-U3-G2

## LED light engine technical information for DMS50 WITH SAG LENS

LAMP	TYPICAL DELIVERED LUMENS	TYPICAL SYSTEM WATTAGE <sup>2</sup> (W)	TYPICAL CURRENT @ 120V (A)	TYPICAL CURRENT @ 208V (A)	TYPICAL CURRENT @ 240V (A)	TYPICAL CURRENT @ 277V (A)	LED CURRENT (mA)	HID EQUIVALENT <sup>3</sup>	LUMINAIRE EFFICACY RATING (LM/W)	BUG RATING
35W32LED4K-R-LE2S	2867	35	0.29	0.17	0.16	0.15	350	70 -100	81.9	B1-U1-G1
35W32LED4K-R-LE3S	3972	35	0.29	0.17	0.16	0.15	350	70 -100	113.5	B1-U1-G1
35W32LED4K-R-LE4S	3691	35	0.29	0.17	0.16	0.15	350	70 -100	105.5	B1-U1-G1
35W32LED4K-R-LE5S	3649	35	0.29	0.17	0.16	0.15	350	70 -100	104.2	B2-U1-G1
55W32LED4K-R-LE2S	5232	52	0.40	0.23	0.21	0.19	530	100 -150	100.6	B1-U1-G1
55W32LED4K-R-LE3S	5553	52	0.40	0.23	0.21	0.19	530	100 -150	106.8	B2-U1-G1
55W32LED4K-R-LE4S	5160	52	0.40	0.23	0.21	0.19	530	100 -150	99.2	B1-U1-G1
55W32LED4K-R-LE5S	5101	52	0.40	0.23	0.21	0.19	530	100 -150	98.1	B3-U1-G1
55W48LED4K-R-LE2S	5395	55	0.38	0.22	0.23	0.21	350	100 -150	98.1	B1-U1-G1
55W48LED4K-R-LE3S	5726	55	0.38	0.22	0.23	0.21	350	100 -150	104.1	B2-U1-G1
55W48LED4K-R-LE4S	5320	55	0.38	0.22	0.23	0.21	350	100 -150	96.7	B1-U1-G2
55W48LED4K-R-LE5S	5259	55	0.38	0.22	0.23	0.21	350	100 -150	95.6	B3-U1-G1
80W48LED4K-R-LE2S	7585	79	0.63	0.36	0.34	0.31	530	150 -175	96.0	B2-U1-G1
80W48LED4K-R-LE3S	8051	79	0.63	0.36	0.34	0.31	530	150 -175	101.9	B2-U1-G2
80W48LED4K-R-LE4S	7481	79	0.63	0.36	0.34	0.31	530	150 -175	94.7	B2-U1-G2
80W48LED4K-R-LE5S	7395	79	0.63	0.36	0.34	0.31	530	150 -175	93.6	B3-U1-G2
70W64LED4K-R-LE2S	7611	71	0.58	0.34	0.32	0.3	350	100 -150	107.2	B2-U1-G1
70W64LED4K-R-LE3S	8077	71	0.58	0.34	0.32	0.3	350	100 -150	113.8	B2-U1-G2
70W64LED4K-R-LE4S	7505	71	0.58	0.34	0.32	0.3	350	100 -150	105.7	B2-U1-G2
70W64LED4K-R-LE5S	7419	71	0.58	0.34	0.32	0.3	350	100 -150	104.5	B3-U1-G2
110W64LED4K-R-LE2S	10752	103	0.8	0.46	0.42	0.38	530	175 -200	104.4	B2-U1-G2
110W64LED4K-R-LE3S	11412	103	0.8	0.46	0.42	0.38	530	175 -200	110.8	B3-U1-G2
110W64LED4K-R-LE4S	10604	103	0.8	0.46	0.42	0.38	530	175 -200	103.0	B2-U1-G2
110W64LED4K-R-LE5S	10482	103	0.8	0.46	0.42	0.38	530	175 -200	101.8	B4-U1-G2
90W80LED4K-R-LE2S	9325	87	0.78	0.43	0.40	0.34	350	150 -175	107.2	B2-U1-G2
90W80LED4K-R-LE3S	9897	87	0.78	0.43	0.40	0.34	350	150 -175	113.8	B3-U1-G2
90W80LED4K-R-LE4S	9197	87	0.78	0.43	0.40	0.34	350	150 -175	105.7	B2-U1-G2
90W80LED4K-R-LE5S	9091	87	0.78	0.43	0.40	0.34	350	150 -175	104.5	B3-U1-G2
135W80LED4K-R-LE2S	13122	129	1.15	0.61	0.58	0.5	530	250 -320	101.7	B3-U1-G2
135W80LED4K-R-LE3S	13927	129	1.15	0.61	0.58	0.5	530	250 -320	108.0	B3-U1-G3
135W80LED4K-R-LE4S	12941	129	1.15	0.61	0.58	0.5	530	250 -320	100.3	B3-U2-G2
135W80LED4K-R-LE5S	12792	129	1.15	0.61	0.58	0.5	530	250 -320	99.2	B4-U2-G2

<sup>1</sup> L70 = 100,000 HRS (AT AMBIENT TEMPERATURE = 25°C AND FORWARD CURRENT = 700 mA)

<sup>2</sup> SYSTEM WATTAGE INCLUDES THE LAMP AND THE LED DRIVER.

<sup>3</sup> EQUIVALENCE SHOULD ALWAYS BE CONFIRMED BY A PHOTOMETRIC LAYOUT.

NOTE : DUE TO RAPID AND CONTINUOUS ADVANCES IN LED TECHNOLOGY, LED LUMINAIRE DATA IS SUBJECT TO CHANGE WITHOUT NOTICE AND AT THE DISCRETION OF PHILIPS.

Philips Lumec reserves the right to substitute materials or change the manufacturing process of its products without prior notification.

For the latest updates go to [WWW.PHILIPS.COM/LUMEC](http://WWW.PHILIPS.COM/LUMEC).

# LAMPS / LED

LED = Philips Lumileds Luxeon R, CRI = 70, CCT = 4000K (+/- 350K)

System (LED + driver) Rated life = 100,000 hrs<sup>1</sup>

## LED light engine technical information for DMS60 WITH FLAT LENS

LAMP	TYPICAL DELIVERED LUMENS	TYPICAL SYSTEM WATTAGE <sup>2</sup> (W)	TYPICAL CURRENT @ 120V (A)	TYPICAL CURRENT @ 208V (A)	TYPICAL CURRENT @ 240V (A)	TYPICAL CURRENT @ 277V (A)	LED CURRENT (mA)	HID EQUIVALENT <sup>3</sup>	LUMINAIRE EFFICACY RATING (LM/W)	BUG RATING
35W32LED4K-R-LE2F	3272	35	0.29	0.17	0.16	0.15	350	70 -100	93.5	B1-U0-G1
35W32LED4K-R-LE3F	3434	35	0.29	0.17	0.16	0.15	350	70 -100	98.1	B1-U0-G1
35W32LED4K-R-LE4F	3183	35	0.29	0.17	0.16	0.15	350	70 -100	90.9	B1-U0-G1
35W32LED4K-R-LE5F	3160	35	0.29	0.17	0.16	0.15	350	70 -100	90.3	B2-U0-G1
55W32LED4K-R-LE2F	4575	52	0.40	0.23	0.21	0.19	530	100 - 150	88.0	B1-U0-G1
55W32LED4K-R-LE3F	4809	52	0.40	0.23	0.21	0.19	530	100 - 150	92.5	B2-U0-G1
55W32LED4K-R-LE4F	4452	52	0.40	0.23	0.21	0.19	530	100 - 150	85.6	B1-U0-G1
55W32LED4K-R-LE5F	4419	52	0.40	0.23	0.21	0.19	530	100 - 150	85.0	B3-U0-G1
55W48LED4K-R-LE2F	4711	55	0.38	0.22	0.23	0.21	350	100 - 150	85.6	B1-U0-G1
55W48LED4K-R-LE3F	4954	55	0.38	0.22	0.23	0.21	350	100 - 150	90.1	B2-U0-G1
55W48LED4K-R-LE4F	4583	55	0.38	0.22	0.23	0.21	350	100 - 150	83.3	B1-U0-G1
55W48LED4K-R-LE5F	4550	55	0.38	0.22	0.23	0.21	350	100 - 150	82.7	B3-U0-G1
80W48LED4K-R-LE2F	6642	79	0.63	0.36	0.34	0.31	530	150 - 175	84.1	B2-U0-G1
80W48LED4K-R-LE3F	6972	79	0.63	0.36	0.34	0.31	530	150 - 175	88.3	B2-U0-G1
80W48LED4K-R-LE4F	6462	79	0.63	0.36	0.34	0.31	530	150 - 175	81.8	B2-U0-G2
80W48LED4K-R-LE5F	6416	79	0.63	0.36	0.34	0.31	530	150 - 175	81.2	B3-U0-G1

## LED light engine technical information for DMS60 WITH PRISMATIC GLOBE

LAMP	TYPICAL DELIVERED LUMENS	TYPICAL SYSTEM WATTAGE <sup>2</sup> (W)	TYPICAL CURRENT @ 120V (A)	TYPICAL CURRENT @ 208V (A)	TYPICAL CURRENT @ 240V (A)	TYPICAL CURRENT @ 277V (A)	LED CURRENT (mA)	HID EQUIVALENT <sup>3</sup>	LUMINAIRE EFFICACY RATING (LM/W)	BUG RATING
35W32LED4K-R-LE2A	3299	35	0.29	0.17	0.16	0.15	350	70 -100	94.3	B1-U3-G1
35W32LED4K-R-LE3A	3280	35	0.29	0.17	0.16	0.15	350	70 -100	93.7	B1-U2-G1
35W32LED4K-R-LE4A	2983	35	0.29	0.17	0.16	0.15	350	70 -100	85.2	B1-U3-G1
55W32LED4K-R-LE2A	4627	52	0.40	0.23	0.21	0.19	530	100 - 150	89.0	B1-U3-G1
55W32LED4K-R-LE3A	4605	52	0.40	0.23	0.21	0.19	530	100 - 150	88.6	B1-U3-G1
55W32LED4K-R-LE4A	4676	52	0.40	0.23	0.21	0.19	530	100 - 150	89.9	B1-U3-G1
55W48LED4K-R-LE2A	4673	55	0.38	0.22	0.23	0.21	350	100 - 150	85.0	B1-U3-G1
55W48LED4K-R-LE3A	4648	55	0.38	0.22	0.23	0.21	350	100 - 150	84.5	B1-U3-G1
55W48LED4K-R-LE4A	4722	55	0.38	0.22	0.23	0.21	350	100 - 150	85.9	B1-U3-G1
80W48LED4K-R-LE2A	6890	79	0.63	0.36	0.34	0.31	530	150 - 175	87.2	B2-U3-G2
80W48LED4K-R-LE3A	6853	79	0.63	0.36	0.34	0.31	530	150 - 175	86.7	B2-U3-G2
80W48LED4K-R-LE4A	6642	79	0.63	0.36	0.34	0.31	530	150 - 175	84.1	B1-U3-G2

## LED light engine technical information for DMS60 WITH SAG LENS

LAMP	TYPICAL DELIVERED LUMENS	TYPICAL SYSTEM WATTAGE <sup>2</sup> (W)	TYPICAL CURRENT @ 120V (A)	TYPICAL CURRENT @ 208V (A)	TYPICAL CURRENT @ 240V (A)	TYPICAL CURRENT @ 277V (A)	LED CURRENT (mA)	HID EQUIVALENT <sup>3</sup>	LUMINAIRE EFFICACY RATING (LM/W)	BUG RATING
35W32LED4K-R-LE2S	3330	35	0.29	0.17	0.16	0.15	350	70 -100	95.1	B1-U1-G1
35W32LED4K-R-LE3S	3534	35	0.29	0.17	0.16	0.15	350	70 -100	101.0	B1-U1-G1
35W32LED4K-R-LE4S	3284	35	0.29	0.17	0.16	0.15	350	70 -100	93.8	B1-U1-G1
35W32LED4K-R-LE5S	3246	35	0.29	0.17	0.16	0.15	350	70 -100	92.7	B2-U1-G1
55W32LED4K-R-LE2S	4656	52	0.40	0.23	0.21	0.19	530	100 - 150	89.5	B1-U1-G1
55W32LED4K-R-LE3S	4942	52	0.40	0.23	0.21	0.19	530	100 - 150	95.0	B1-U1-G1
55W32LED4K-R-LE4S	4592	52	0.40	0.23	0.21	0.19	530	100 - 150	88.3	B1-U1-G1
55W32LED4K-R-LE5S	4539	52	0.40	0.23	0.21	0.19	530	100 - 150	87.3	B3-U1-G1
55W48LED4K-R-LE2S	4794	55	0.38	0.22	0.23	0.21	350	100 - 150	87.2	B1-U1-G1
55W48LED4K-R-LE3S	5088	55	0.38	0.22	0.23	0.21	350	100 - 150	92.5	B2-U1-G1
55W48LED4K-R-LE4S	4728	55	0.38	0.22	0.23	0.21	350	100 - 150	86.0	B1-U1-G1
55W48LED4K-R-LE5S	4674	55	0.38	0.22	0.23	0.21	350	100 - 150	85.0	B3-U1-G1
80W48LED4K-R-LE2S	6759	79	0.63	0.36	0.34	0.31	530	150 - 175	85.6	B2-U1-G1
80W48LED4K-R-LE3S	7174	79	0.63	0.36	0.34	0.31	530	150 - 175	90.8	B2-U1-G2
80W48LED4K-R-LE4S	6666	79	0.63	0.36	0.34	0.31	530	150 - 175	84.4	B2-U1-G2
80W48LED4K-R-LE5S	6590	79	0.63	0.36	0.34	0.31	530	150 - 175	83.4	B3-U1-G1

<sup>1</sup> L70 = 100,000 HRS (AT AMBIENT TEMPERATURE = 25°C AND FORWARD CURRENT = 700 mA)

<sup>2</sup> SYSTEM WATTAGE INCLUDES THE LAMP AND THE LED DRIVER.

<sup>3</sup> EQUIVALENCE SHOULD ALWAYS BE CONFIRMED BY A PHOTOMETRIC LAYOUT.

NOTE : DUE TO RAPID AND CONTINUOUS ADVANCES IN LED TECHNOLOGY, LED LUMINAIRE DATA IS SUBJECT TO CHANGE WITHOUT NOTICE AND AT THE DISCRETION OF PHILIPS.

Philips Lumec reserves the right to substitute materials or change the manufacturing process of its products without prior notification.

For the latest updates go to [WWW.PHILIPS.COM/LUMEC](http://WWW.PHILIPS.COM/LUMEC).

# LAMPS / LED

## VOLTAGE

120 / 208 / 240 / 277 / 347 / 480

# OPTICAL SYSTEMS / LED



### Flat lens

IP66 rated optical system, composed of individual pre-oriented lens to achieve desired distribution, assembled with a tempered-glass flat lens permanently sealed onto the lower part of the heat sink.

LE2F: Asymmetrical  
LE3F: Asymmetrical  
LE4F: Asymmetrical  
LE5F: Symmetrical (square)

> House shield available in option (HS)



### Sag lens

IP66 rated optical system, composed of individual pre-oriented lens to achieve desired distribution, assembled with a tempered-glass sag lens permanently sealed onto the lower part of the heat sink.

LE2S: Asymmetrical  
LE3S: Asymmetrical  
LE4S: Asymmetrical  
LE5S: Symmetrical (square)

> House shield available in option (HS)



### Prismatic globe

IP66 rated optical system, composed of individual pre-oriented lens to achieve desired distribution, assembled with globe having an inner prismatic surface permanently sealed onto the lower part of the heat sink.

LE2A: Asymmetrical  
LE3A: Asymmetrical  
LE4A: Asymmetrical

> LE2A/LE3A/LE4A available in acrylic and borosilicate.

> House shield available in option (HS)

Add suffix ACDR or PC to optical system code.

\* Photometry available on Philips Lumec web site [www.philips.com/lumec](http://www.philips.com/lumec).

# LAMPS / HID

WATTAGE	DMS50			DMS60		
	SCB3M SHA3M-PC SSA3M-PC	SHA3M-ACDR SSA3M-ACDR	SG	SCB3M SHA3M-PC SSA3M-PC	SHA3M-ACDR SSA3M-ACDR	SG
50 MH, medium	✓	✓	✓	✓	✓	RB
70 MH, medium	✓	✓	✓	✓	✓	RB
100 MH, medium	✓	✓	✓	✓	✓	RB
150 MH, medium	✓	✓	✓	✓	✓	RB
200 MH, mogul	✓	N/A	✓	✓	N/A	RB
175 PSMH, mogul	✓	N/A	✓	✓	✓	N/A
250 PSMH, mogul	✓	N/A	✓	✓	N/A	RB
400 PSMH, mogul <sup>(1)</sup>	N/A	N/A	RB, RJ	N/A	N/A	N/A
35 HPS, mogul	✓	✓	✓	✓	✓	RB
50 HPS, mogul	✓	✓	✓	✓	✓	RB
70 HPS, mogul	✓	✓	✓	✓	✓	RB
100 HPS, mogul	✓	✓	✓	✓	✓	RB
150 HPS, mogul	✓	✓	✓	✓	✓	RB
200 HPS, mogul <sup>(1)</sup>	✓	N/A	✓	✓	N/A	RB
250 HPS, mogul <sup>(1)</sup>	✓	N/A	✓	✓	N/A	RB
400 HPS, mogul <sup>(1)</sup>	N/A	N/A	RB	N/A	N/A	N/A

✓ : Available    N/A : Not available    RB : Remote Ballast Required

RJ : Reduced Jacket ED28 Required    1 : N/A with SGFM

## CosmoPolis™ / new generation of ceramic metal halide lamp

WATTAGE	SCB3M / SHA3M-PC / SSA3M-PC	SHA3M-ACDR / SSA3M-ACDR
60 CW	✓	✓
90 CW	✓	✓
140 CW <sup>1</sup>	✓	✓

✓ : Available    1 : Not available with 120 volts

# OPTICAL SYSTEMS / HID

(Lamps not included)



### SHA and SSA optics

Sealed optical chamber consisting of a reflector permanently assembled of top of an internal prismatic globe.

SHA3M: Asymmetrical  
SHA3M: Asymmetrical

> House shield available in option (HS)

In the above optics, the sleeve and shutter permit exact positioning of the lamp. SHA & SSA refractors available in: **ACDR**: Acrylique (175 W max.)  
**PC**: Polycarbonate. Add suffix to optical system code.



### SCB optics

Sealed optical chamber consisting of a reflector permanently assembled on top of a tempered-glass sag lens.

SCB3M: Asymmetrical

> House shield available in option (HS)



### SG Optics

Segmented cut-off reflector system set in faceted arc-image duplicating patterns.

SGQ: Symmetrical  
SG1: Symmetrical  
SG2: Asymmetrical  
SG3: Asymmetrical  
SGFM: Forward throw

> House shield available for SG2 and SG3

In the above optics, the sleeve and shutter permit exact positioning of the lamp.

\* Photometry available on Philips Lumec web site [www.philips.com/lumec](http://www.philips.com/lumec).

# VOLTAGE

DHI<sup>1</sup>: 120 / 208 / 240 / 277 / 347 / 480

CosmoPolis™: 120 / 208 / 240 / 277

<sup>1</sup> Multi-top ballast also available.

# LAMPS / QL

WATTAGE	SCB5	SHA
55 QL	✓	✓
85 QL	✓	✓

✓ : Available

High frequency generator for induction lamp (4000K).  
Instant start. Operating range 50-60 Hz or DC.  
Lamp minimum starting temperature -40F (-40 °C).

# VOLTAGE

120 / 208 / 240 / 277

# OPTICAL SYSTEMS / QL

(Lamps included)



### SHA optics

Sealed optical chamber consisting of a reflector permanently assembled of top of an internal prismatic globe.

SHA: Asymmetrical

> House shield available in option (HS)



### SCB5 optics

Sealed optical chamber consisting of a reflector permanently assembled on top of a tempered-glass sag lens.

SCB5: Symmetrical

> House shield available in option (HS)

\* Photometry available on Philips Lumec web site [www.philips.com/lumec](http://www.philips.com/lumec).

# LUMINAIRE OPTIONS

- HS** House shield  
(Not available with LED)
- LD** Luminous dome, 250 W maximum  
(SG optics only) (only with DMS50)  
(remote ballast for 200 and 250 W in bracket or pole)  
(Not available with LED)
- LR** Luminous ring,  
250 W maximum  
(SG optics only) (only with DMS50)  
(remote ballast for 200 and 250 W in bracket or pole)  
(Not available with LED)
- SLG** Tempered glass sag lens  
(SG optics only)(Not available with LED)

# ADAPTORS

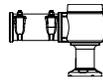

## SMB

The luminaire is suspended by means of a decorative side-mounting cast-aluminium adaptor. This adaptor accepts tubes from 1 5/8" to 2 3/8" (41 to 60 mm) and is adjustable to more or less 50.

# SMART LUMINAIRE OPTIONS

Domus allows you many options in order to get different smart functionalities.

## **DMG** (available with LifeLED and LEDgine\*)

Driver is compatible with dimmer from 0 to 10 volts.

## **CDMG** (available with LifeLED and LEDgine\*)

Dynadimmer standard dimming functionalities including pre-programmed scenarios to suit many applications and needs from safety to maximum energy savings. (see Dynadimmer brochure for more information on pre-programmed scenarios)

## **CDMGP** (available with LifeLED and LEDgine\*)

Dynadimmer custom dimming scenario allowing the user to program up to 5 time periods and multiple dimming levels from 100% to 10% of total wattage.

## **OVR** (available with LEDgine\* only)

Dynadimmer override function offering the possibility to go back to full power at any time via an electrical signal of 120VAC to 277VAC from a motion sensor, a switch, a relay or else.

## **CLO** (available with LEDgine\* only)

Pre-set driver to manage the lumen depreciation by adjusting the power given to the LEDs offering the same lighting intensity during the entire lifespan of the lamp.

## **AST** (available with LEDgine\* only)

Pre-set driver for progressive start-up of the lamp to optimize energy management and enhance user visual comfort at start-up.

## **OTL** (available with LEDgine\* only)

Pre-set driver to signal end of life of the lamp for better fixture management.

## **DALI** (available with LEDgine\* only)

Pre-set driver compatible with the DALI control system.

\* Not available with 347 and 480 volt.

# SMART SYSTEM OPTIONS

Different options are available according to your needs. Please contact us for more information.

# SMART CITY OPTIONS

## **AMPLIGHT** (available with LEDgine\* only)

Amplight is the intelligent monitoring and control, automated management system that delivers up to 35% streetlight energy savings and makes it easy to monitor and manage the entire system, in real time. Please contact us for more information.

\* Not available with 347 and 480 volt.

Other options are also available according to your needs. Please contact us for more information.

# MOUNTINGS

(Consult the Pole Guide for details and the complete line of mountings)

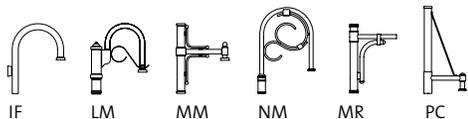

# POLES AND POLE OPTIONS

(Consult the Pole Guide for details and the complete line of poles)

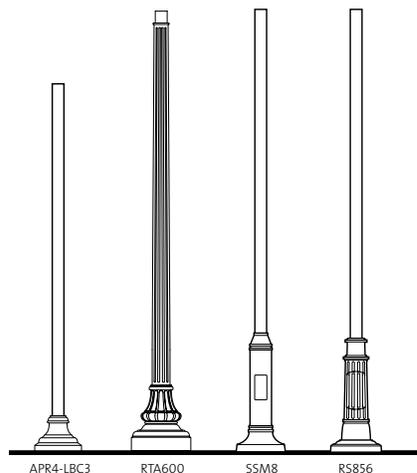

# FINISHES

(Consult Philips Lumec's Color Chart for complete specifications)

The specially formulated **Lumital** powder coat finish is available in a range of many standard colors.

# ORDERING SAMPLE

LUMINAIRE	LAMP	GLOBE/LENS	OPTICAL SYSTEM	VOLTAGE	ADAPTOR	OPTIONS	MOUNTING & CONFIGURATION	POLE	FINISH
DM550	100 HPS	ACDR	SHA3L-ACDR	120	SMB	FS-LR	MR-1A	R80-15	GNTX

# MAINTENANCE



## ACCESS TO INTERNAL COMPONENT

The luminaire's hood can be opened by simply applying pressure on the latch located on the technical ring. The hood can then be pivoted along a hinge incorporated in the technical ring. A built-in stopper holds the cover at 90° from the technical ring.



## ACCESS TO LAMP

A simple quarter-turn of the **Smartseal™** shutter provides easy access to the lamp. Quick-disconnect terminals between the lamp and the ballast tray ensure safe and easy lamp replacement.



## ACCESS TO BALLAST

The tool-free drop-in unitized ballast tray is slipped into the post top box which rests on the optical support plate. Here again, the use of quick-disconnect terminals ensures safe and easy ballast maintenance.

# ASSEMBLY EXAMPLES

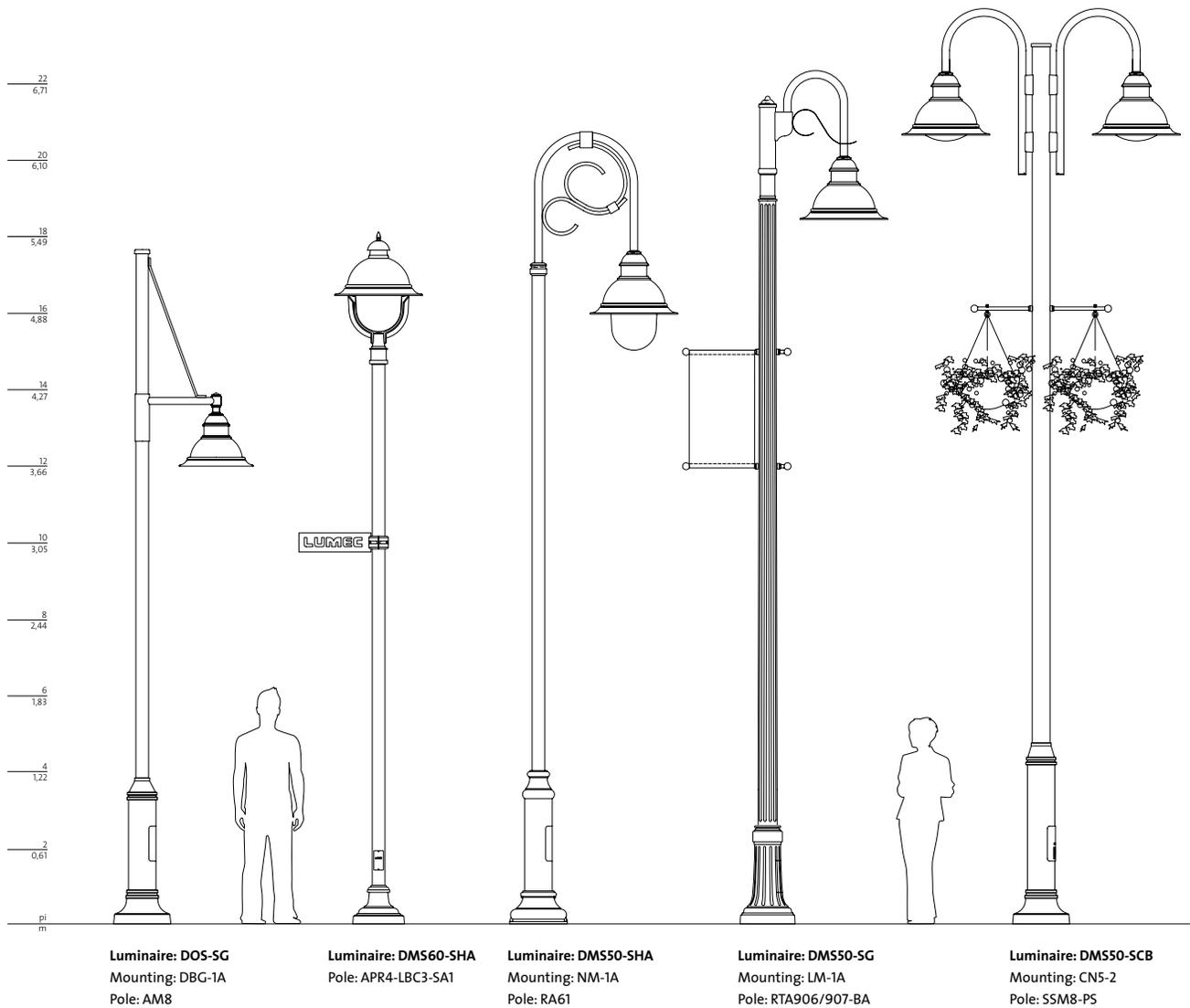



>>  
LUMINAIRE > DMS50-SCB  
BRACKET > CUSTOM  
POLE > SSM8





© 2014 Koninklijke Philips N.V. All rights reserved.  
Specifications are subject to change without notice.  
[www.philips.com/luminaires](http://www.philips.com/luminaires)

Philips Lighting Company  
200 Franklin Square Drive  
Somerset, NJ 08873  
Phone: 855-486-2216

Philips Lighting Company  
281 Hillmount Road  
Markham ON, Canada L6C 2S3  
Phone: 800-668-9008

Job:  
Type:  
Notes:

# Form 10 Square LED

## BE / BH / WE / WH Wall Mount

Page 1 of 3

The Philips Gardco wall mounted Square Form 10 LED products are cutoff luminaires featuring LED arrays. Square Form 10 LED luminaires provide performance excellence and advanced Philips Gardco LED thermal management technology. High performance Class 1 LED systems offer the potential for energy savings up to 50 % when compared to HID systems. The BE/WE units are manufactured from mitered extruded aluminum and finished in an Architectural Class 1 anodizing. The BH/WH style luminaires are die formed aluminum with a thermoset polyester finish. Form 10 Square LED luminaires provide full cutoff performance and feature a flat glass lens.

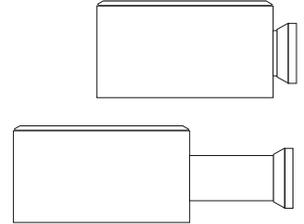

PREFIX	MOUNTING	DISTRIBUTION	LED WATTAGE	LED SELECTION	VOLTAGE	FINISH	OPTIONS
<input type="text"/>	<input type="text"/>	<input type="text"/>	<input type="text"/>	<input type="text"/>	<input type="text"/>	<input type="text"/>	<input type="text"/>

Enter the order code into the appropriate box above. Note: Philips Gardco reserves the right to refuse a configuration. Not all combinations and configurations are valid. Refer to notes below for exclusions and limitations. For questions or concerns, please consult the factory.

### PREFIX

#### Available in 70LA and 85LA LED Wattages Only

With Arm

Without Arm

<b>BE14L</b>	<b>WE14L</b>	14" Square Extruded Luminaire LED - Constant Wattage
<b>BE14L-DIM</b>	<b>WE14L-DIM</b>	14" Square Extruded Luminaire LED - 0-10V Dimming
<b>BH14L</b>	<b>WH14L</b>	14" Square Fabricated Luminaire LED - Constant Wattage
<b>BH14L-DIM</b>	<b>WH14L-DIM</b>	14" Square Fabricated Luminaire LED - 0-10V Dimming

#### Available in 110LA and 160LA LED Wattages Only

With Arm

Without Arm

<b>BE19L</b>	<b>WE19L</b>	19" Square Extruded Luminaire LED - Constant Wattage
<b>BE19L-DIM</b>	<b>WE19L-DIM</b>	19" Square Extruded Luminaire LED - 0-10V Dimming
<b>BH19L</b>	<b>WH19L</b>	19" Square Fabricated Luminaire LED - Constant Wattage
<b>BH19L-DIM</b>	<b>WH19L-DIM</b>	19" Square Fabricated Luminaire LED - 0-10V Dimming

### MOUNTING

1 Single

### DISTRIBUTION

- 2 Type II
- 3 Type III
- 4 Type IV
- 5 Type V

Type II, Type III and Type IV optics are field rotatable. Type V optics feature unitized lens.

Retrofit Kits for existing Form 10 Square 14" and 19" HID luminaires are available. See Legacy LED Retrofit Kits Submittal Data Sheet (G200-21) for Retrofit Kit information.

### LED WATTAGE AND LUMEN VALUES

Ordering Code	Average System Watts <sup>1</sup>	LED Current (mA)	LED Selection	Luminaire Initial Absolute Lumens <sup>2,3</sup>				Basis of Lumen Data : Photometric tests performed in compliance with IESNA LM-79, except where otherwise indicated. Notes: 1. Wattage may vary by +/- 8% due to LED manufacturer forward volt specification and ambient temperature. Wattage shown is average for 120V through 277V input. Actual wattage may vary by an additional +/- 10% due to actual input voltage. 2. Values shown are for luminaires without the HS external shield option. Tests are in process for luminaires with the HS option and WW luminaires. Contact Gardco.applications@philips.com if approximate estimates are required for design purposes. 3. LED arrays feature LEDs that provide from 100 to 130 lumens per watt when operated at 350 mA. Lumen values based on tests performed in compliance with IESNA LM-79.
				TYPE 2	TYPE 3	TYPE 4	TYPE 5	
70LA	70	350	NW	7,240	7,467	7,303	7,162	
85LA	85	350	NW	8,900	9,318	9,045	8,921	
110LA	110	350	NW	10,928	11,053	11,050	10,755	
160LA	160	530	NW	15,252	15,659	15,109	15,422	

### LED SELECTION

<b>CW</b>	Cool White - 5700°K - 75 CRI
<b>NW</b>	Neutral White - 4000°K - 70 CRI
<b>WW</b>	Warm White - 3000°K - 80 CRI

### VOLTAGE

<b>UNIV</b>	120V through 277V, 50hz or 60hz
<b>HVU</b>	347V through 480V, 50hz or 60hz (High Voltage Universal)
<b>120</b>	
<b>208</b>	
<b>240</b>	
<b>277</b>	
<b>347</b>	
<b>480</b>	



**PHILIPS**



# Form 10 Square LED

BE / BH / WE / WH Wall Mount

## FINISH

### BE / WE

- BRA** Bronze Anodized
- BLA** Black Anodized
- NA** Natural Anodized
- OC** Optional Color Paint  
*Specify Optional Color or RAL ex: OC-LGP or OC-RAL7024.*
- SC** Special Paint  
*Specify. Must supply color chip.*

## OPTIONS

- F<sup>4</sup>** Fusing In Head
- PC<sup>4</sup>** Photocontrol and Receptacle
- PCR** Photocontrol Receptacle only

<sup>4</sup> Not available in 480V. Provide specific input voltage.

### BH/WH

- BRP** Bronze Paint
- BLP** Black Paint
- OC** Optional Color Paint  
*Specify Optional Color or RAL ex: OC-LGP or OC-RAL7024.*
- SC** Special Paint  
*Specify. Must supply color chip.*

## DIMENSIONS

### BE/BH

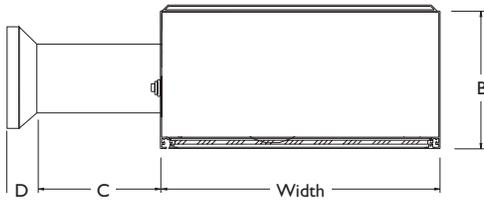

Size	Width	B	C	D
14	14" 35.56 cm	7" 17.78 cm	6" 15.24 cm	2" 5.08 cm
19	19" 48.26 cm	10" 25.40 cm	9" 22.86 cm	2" 5.08 cm

### WE/WH

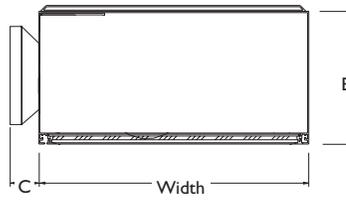

Size	Width	B	C
14	14" 35.56 cm	7" 17.78 cm	2" 5.08 cm
19	19" 48.26 cm	10" 25.40 cm	2" 5.08 cm

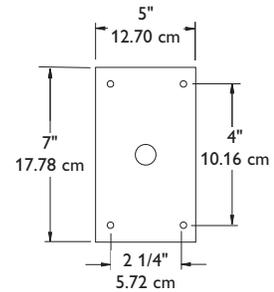

Wall Mounting Dimensions

# Form 10 Square LED

BE / BH / WE / WH Wall Mount

## LUMINAIRE CONFIGURATION INFORMATION

**CONSTANT WATTAGE CONFIGURATIONS:** Standard LED luminaires provide constant wattage and constant light output when power to the luminaire is energized.

**DIMMING "-DIM" CONFIGURATIONS:** Dimmable LED luminaires are provided with 0 -10V dimming for connection to a control system provided by others.

## SPECIFICATIONS

**GENERAL:** The Philips Gardco wall mounted Square Form 10 LED products are cutoff luminaires featuring LED arrays. Square Form 10 LED luminaires provide performance excellence and advanced Philips Gardco LED thermal management technology. High performance Class 1 LED systems offer the potential for energy savings up to 50 % when compared to HID systems. The BE and WE units are manufactured from mitered extruded aluminum and finished in an Architectural Class 1 anodizing. The BH and WH style luminaires are die formed aluminum with a thermoset polyester finish. Form 10 Square LED luminaires provide full cutoff performance and feature a flat glass lens.

**HOUSING:** Extruded housings (BE/WE styles) are composed of precisely mitered anodized aluminum extrusions. Fabricated (BH/WH styles) units are one piece, multi-formed aluminum with an integral reinforcing spline and a single concealed joint. Pressure injected silicone provides a continuous weather tight seal at all miters and points of material transition.

**ARM:** Extruded aluminum arm is wired and secured to luminaire by contractor. Assembly is suitable for mounting without requiring access to luminaire.

**LENS:** Mitered, extruded anodized aluminum door frame retains the optically clear, heat and impact resistant tempered flat glass in a sealed manner using hollow section, high compliance, memory retentive extruded silicone rubber. Concealed stainless steel latch and hinge permit easy toolless access to the luminaire.

**THERMAL MANAGEMENT:** The Philips Gardco Form 10 Square LED luminaires utilize extruded aluminum integral thermal radiation fins to provide the excellent thermal management so critical to long LED system life.

### LED RELIABILITY:

PREDICTED LUMEN DEPRECIATION DATA		
Ambient Temperature °C	Driver mA	L <sub>70</sub> Hours <sup>6</sup>
25 °C	350 mA	150,000
	530 mA	100,000
40 °C	350 mA	100,000
	530 mA	70,000

6. Predicted performance derived from LED manufacturer's data and engineering design estimates, based on IESNA LM-80 methodology. Actual experience may vary due to field application conditions. L<sub>70</sub> is the predicted time when LED performance depreciates to 70% of initial lumen output.

**OPTICAL SYSTEMS:** Philips Gardco Form 10 Square LED luminaires utilize lensed LED arrays set to achieve IES Type II, Type III, Type IV and Type V distributions. Individual LED arrays are replaceable. Optical systems are field rotatable. Luminaires feature high performance Class 1 LED systems.

**ELECTRICAL:** Luminaires include a complete prewired LED driver assembly, provided as part of the optical assembly. Luminaires include an LED driver that accepts 120V through 277V, or 347V through 480V, 50hz to 60hz, input. Driver output is based on the LED wattage selected. Component-to-component wiring within the luminaire will carry no more than 80% of rated current and is listed by UL for use at 600VAC at 302°F / 150°C or higher. Plug disconnects are listed by UL for use at 600 VAC, 15A or higher. Power factor is not less than 90%. Luminaires consume 0.0 watts in the off state. Surge protector standard. 10KA per ANSI/IEEE C62.41.2.

**FINISH:** Extruded housings (BE/WE styles) are standard with natural, bronze, or black Aluminum Association Architectural Class I anodized finish. Special color polyester finishes are available. Formed housings (BH/WH styles) are standard with a chromatic acid pretreatment. The finish coat is a thermosetting polyester baked at 450°F / 232°C to achieve an H-2H hardness measure. 2

**LABELS:** All luminaires bear UL or CUL (where applicable) Wet Location labels.

**WARRANTY:** Philips Gardco Form 10 Square LED luminaires feature a 5 year limited warranty, including a 5 year limited warranty covering LED arrays and LED drivers. See Warranty Information on [www.sitelighting.com](http://www.sitelighting.com) for complete details and exclusions.

**FULL CUTOFF PERFORMANCE:** Full cutoff performance means a luminaire distribution where zero candela intensity occurs at an angle at or above 90° above nadir. Additionally, the candela per 1000 lamp lumens does not numerically exceed 100 (10 percent) at a vertical angle of 80° above nadir. This applies to all lateral angles around the luminaire.

**CUTOFF PERFORMANCE:** Cutoff performance means a luminaire distribution where the candela per 1000 lamp lumens does not numerically exceed 25 (2.5 percent) at an angle at or above 90° above nadir, and 100 (10 percent) at a vertical angle of 80° above nadir. This applies to all lateral angles around the luminaire.



© 2014 Koninklijke Philips N.V. All rights reserved.

Philips reserves the right to make changes in specifications and/or to discontinue any product at any time without notice or obligation and will not be liable for any consequences resulting from the use of this publication.

Philips Lighting  
North America Corporation  
200 Franklin Square Drive  
Somerset, NJ 08873  
Tel. 855-486-2216

Imported by: Philips Lighting,  
A division of Philips Electronics Ltd.  
281 Hillmount Rd,  
Markham, ON, Canada L6C 2S3  
Tel. 800-668-9008

# Classic elegance meets advanced lighting technology

## METROSCAPE LED POST-TOP URBAN LUMINAIRE

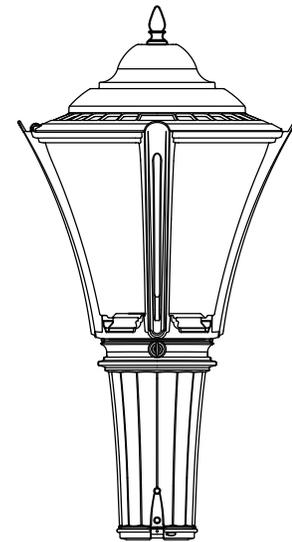

### PHILIPS LUMEC METROSCAPE LED POST-TOP URBAN LUMINAIRE

The Philips Lumec MetroScape LED post-top luminaire features flexible, robust energy-saving solutions for heritage-styled urban architectural lighting. Crowned with an ornamental hood, the post-top model comes with a flat lens to highlight the thinness of the LEDs. The luminaire provides attractive lighting at night, adding appeal to the surroundings and promoting safe use of the environment.

Project: \_\_\_\_\_  
 Location: \_\_\_\_\_  
 Catalog No: \_\_\_\_\_  
 Fixture Type: \_\_\_\_\_  
 Mfg: \_\_\_\_\_ Lamps: \_\_\_\_\_ Qty: \_\_\_\_\_  
 Notes: \_\_\_\_\_

### Ordering guide

Luminaire	LED Module	Optical System	Voltage	Driver Options	Luminaire Options	Mounting	Pole	Accessories	Finish
<b>MPTR</b>						<b>—</b>	<b>—</b>		
<b>MPTR</b> <sup>1</sup> : MetroScape Post-Top LED Luminaire	<b>16W16LED4K-T</b> <sup>2</sup> <b>24W16LED4K-T</b> <sup>2</sup> <b>30W16LED4K-T</b> <sup>2</sup> <b>48W16LED4K-T</b> <sup>2</sup> <b>35W32LED4K-T</b> <sup>2</sup> <b>55W32LED4K-T</b> <sup>2</sup> <b>72W32LED4K-T</b> <sup>2</sup> <b>97W32LED4K-T</b> <sup>2</sup> <b>55W48LED4K-T</b> <sup>2</sup> <b>80W48LED4K-T</b> <sup>2</sup> <b>108W48LED4K-T</b> <sup>2</sup> <b>140W48LED4K-T</b> <sup>2</sup> <b>70W64LED4K-T</b> <sup>2</sup> <b>110W64LED4K-T</b> <sup>2</sup> <b>90W80LED4K-T</b> <sup>2</sup> <b>135W80LED4K-T</b> <sup>2</sup>	<b>LE2</b> : Type II (ASYM) flat lens <b>LE3</b> : Type III (ASYM) flat lens <b>LE3W</b> <sup>3</sup> : Type III (ASYM) wide flat lens <b>LE4</b> : Type IV (ASYM) flat lens <b>LE5</b> : Type V (SYMM) flat lens	<b>120</b> : 120V <b>208</b> : 208V <b>240</b> : 240V <b>277</b> : 277V <b>347</b> : 347V <sup>4</sup> <b>480</b> : 480V <sup>4</sup>	<b>CDMG</b> : Dynadimmer for standard dimming <b>CLO</b> : Pre-set driver to manage lumen depreciation <b>AST</b> : Pre-set driver for progressive start-up <b>OTL</b> : Pre-set driver to signal end of life of the lamp <b>DALI</b> : Pre-set driver compatible with the DALI control system	<b>HS</b> : House Side Shield <b>OVR</b> : Dynadimmer override function <b>PH8</b> : Photoelectric cell <b>PH8XL</b> <sup>5</sup> : Photoelectric cell, extended life <b>PH9</b> : Shorting Cap <b>RCD</b> <sup>6</sup> : 5-Pin receptacle for dimming photoelectric cell <b>TN3</b> <sup>7</sup> : Fitter to fit over a 3" (76 mm) O.D. by 4" (102 mm) long tenon <b>TN3.5</b> <sup>7</sup> : Fitter to fit over a 3 1/2" (89 mm) O.D. by 4" (102 mm) long tenon	Consult the Philips web site for details and the complete line of Mountings	Consult the Philips web site for details and the complete line of Poles	<b>SPC</b> <sup>7a</sup> : Starsense Photo-cell Control Node On-Off <b>SPCD</b> <sup>7a</sup> : Starsense Photo-cell Control Node Dimming	<b>BE2TX</b> <b>BE6TX</b> <b>BE8TX</b> <b>BG2TX</b> <b>BKTX</b> <b>BRTX</b> <b>GN4TX</b> <b>GN6TX</b> <b>GN8TX</b> <b>GNTX</b> <b>GR</b> <b>GY3TX</b> <b>NP</b> <b>RD2TX</b> <b>RD4TX</b> <b>TG</b> <b>TS</b> <b>WHTX</b> <i>(Consult pg 4 for code descriptions)</i>

example: MPTR-42W32LED4K-T-LE3-120-CDMGM25-PH8-BKTX

1. Luminaire is always shipped with a dimmable 0-10V driver (except for 35W32LED4K).  
 2. 347V and 480V not available.  
 3. Not available with HS option.  
 4. Not available with driver options.  
 5. Use of photoelectric cell or shorting cap is required to ensure proper illumination.

6. Not available with Motion Response.  
 7. Luminaire option RCD is required with this accessory.  
 8. CDMG, CDMGP and DALI are not available with SPC and SPCD.



# METROSCAPE LED POST-TOP URBAN LUMINAIRE

## Ordering Guide (Accessories) - Motion Response\*

Must be ordered as a separate line item

example: ACC-120-MR4PGI-BKTX

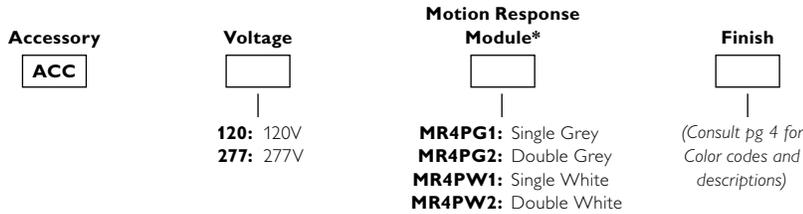

\*OVR option is required for Motion Response Accessory

## Dimensions - MetroScape Post-Top LED (MPTR) Luminaire

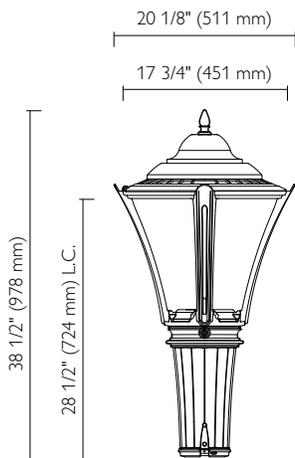

**EPA:**  
1.97 sq ft

**Luminaire Weight:**  
31.1 lbs (14.1 kg)

## Specifications

### Cage:

In a round shape with 4 arms and a built-in mechanical ring, this cage is a one piece die cast A360 Aluminum alloy 0.100 (2.5mm) minimum thickness, mechanically assembled to the fitter.

### Fitter:

Made of die cast A360.1 Aluminum alloy 0.100 (2.5mm) minimum thickness, the fitter is complete with a watertight access door giving access to the driver rated IP66, and a terminal block that accepts (#2 max.) wires from the primary circuit. Comes with an easy self adjusting system with two (2) set screws 3/8 16 UNC for ease of maintenance and installation. Fits on a 4" (102mm) outside diameter by 4" (102mm) long tenon.

## Specifications (continued)

### Finial:

Decorative cast 356 aluminum, mechanically assembled.

### Hood:

Made of die cast A360.1 Aluminum alloy 0.100 (2.5mm) minimum thickness, mechanically assembled to the cast aluminum heat sink.

### Access-Mechanism:

A die cast A360.1 Aluminum alloy 0.100 (2.5mm) minimum thickness technical ring with latch and hinge.

### Light Engine:

LED engine is composed of 4 main components: LED lamp / Optical System / Heat Sink / Driver  
Electrical components are RoHS compliant.

### LEx Lens

**Flat Lens:** Made of soda lime clear tempered glass, mechanically assembled and sealed onto the ring of the access mechanism.

### LED Module

LED type Philips Lumileds LUXEON T. Composed of high performance white LEDs. Color temperature of 4000 Kelvin nominal, 70 CRI. Operating lifespan 100,000 hours (see chart for specific lifetime based on mA) based on TM 21 extrapolation to get results after which 50% of LEDs still emits over 70% (L70) of its original lumen output. Use of metal core board ensures greater heat transfer and longer lifespan of the light engine.

### Optical System:

Composed of high performance optical polymer refractor lenses to achieve desired distribution optimized to get maximum spacing, target lumens and a superior lighting uniformity. System is rated IP66. Performance shall be tested per LM 63, LM 79 and TM 15 (IESNA) certifying its photometric performance. Street side indicated. Dark Sky compliant with 0% uplight and U0 per IESNA TM 15.

### Heat Sink:

Made of cast aluminum optimizing the LEDs efficiency and life. Product does not use any cooling device with moving parts (only passive cooling device).

### Driver:

High power factor of 95%. Electronic driver, operating range 50/60 Hz. Auto adjusting universal voltage input from 120 to 277 and 347 to 480 VAC rated for both application line to line or line to neutral, Class I, THD of 20% max. Maximum ambient operating temperature from 40F (40C) to 130F (55C) degrees. Certified in compliance to UL1310 cULus requirement. Dry and damp location. Assembled on a unitized removable tray with Tyco quick disconnect plug resisting to 221F(105C) degrees. Dimmable driver 0-10V.

The current supplying the LEDs will be reduced by the driver if the driver experiences internal overheating as a protection to the LEDs and the electrical components. Output is protected from short circuits, voltage overload and current overload. Automatic recovery after correction. Standard built in driver surge protection of 2.5kV (min).

### Surge Protector:

Surge protector tested in accordance with ANSI/IEEE C62.45 per ANSI/IEEE C62.41.2 Scenario I Category C High Exposure 10kV/10kA waveforms for Line Ground, Line Neutral and Neutral Ground, and in accordance with U.S. DOE (Department of Energy) MSSLC (Municipal Solid State Street Lighting Consortium) model specification for LED roadway luminaires electrical immunity requirements for High Test Level 10kV / 10kA.

## Specifications (continued)

### Driver Options

**CDMG:** Dynadimmer standard dimming functionalities including pre-programmed scenarios to suit many applications and needs from safety to maximum energy savings.

Scenario	Dimming Time	Dimming Level	Ordering Code
Safety	4 hours	25% power dimming	CDMG <b>S25</b>
Safety	4 hours	50% power dimming	CDMG <b>S50</b>
Safety	4 hours	75% power dimming	CDMG <b>S75</b>
Median	6 hours	25% power dimming	CDMG <b>M25</b>
Median	6 hours	50% power dimming	CDMG <b>M50</b>
Median	6 hours	75% power dimming	CDMG <b>M75</b>
Economy	8 hours	25% power dimming	CDMG <b>E25</b>
Economy	8 hours	50% power dimming	CDMG <b>E50</b>
Economy	8 hours	75% power dimming	CDMG <b>E75</b>
Programmable	Determined by user	Determined by user	CDMG <b>P</b>

**CLO:** Pre-set driver to manage the lumen depreciation by adjusting the power given to the LEDs offering the same lighting intensity during the entire lifespan of the LED module.

**AST:** Pre-set driver for progressive start-up of the LED module(s) to optimize energy management and enhance visual comfort at start-up.

**OTL:** Pre-set driver to signal end of life of the LED module(s) for better fixture management.

**DALI:** Pre-set driver compatible with the DALI control system.

### Luminaire Options

**HS:** House Side Shield



**PH9:** Shorting cap, Twist-lock Type complete with receptacle.

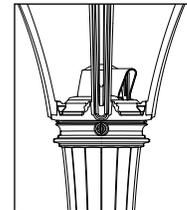

**PH9** installed on luminaire

**OVR:** Dynadimmer override function

**PH8:** Photoelectric cell, Twist-lock Type complete with receptacle and a decorative cap made of polycarbonate with a plastic lens. Allows a 90 degree rotation. Color of cap is grey.

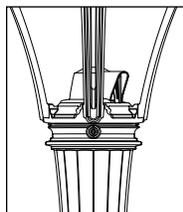

**PH8** installed on luminaire

**RCD:** Receptacle with 5 pins allowing dimming, can be used with a twist-lock Starsense, photoelectric cell or a shorting cap.

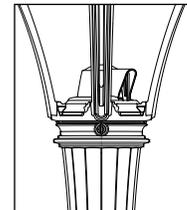

**RCD** installed on luminaire

**PH8XL:** Extended life photoelectric cell, Twist-lock Type complete with receptacle and a decorative cap made of polycarbonate with a plastic lens. Allows a 90 degree rotation. Color of cap is grey.

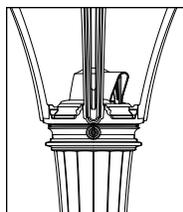

**PH8XL** installed on luminaire

**TN3:** Fitter to fit over a 3" (76 mm) O.D. by 4" (102 mm) long tenon

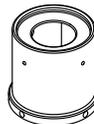

**TN3.5:** Fitter to fit over a 3 1/2" (89 mm) O.D. by 4" (102 mm) long tenon



# METROSCAPE LED POST-TOP URBAN LUMINAIRE

## Specifications (continued)

### Finials:

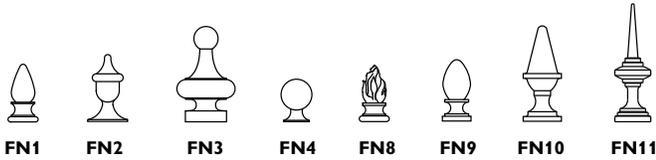

### Luminaire Accessories:

#### Connected Lighting

**SPC:** Starsense telemanagement system for monitoring, controlling, metering and diagnosing outdoor lighting networks. Starsense is based on two-way wireless communication using the latest in mesh network technology. This option gives ON/OFF control of the luminaires but does not support dimming. Complete with a decorative cap made of polycarbonate with a plastic lens. Allows a 90 degree rotation. Color of cap is grey.

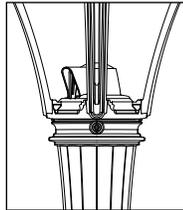

**SPC** installed on luminaire

**SPCD:** Starsense telemanagement system for monitoring, controlling, metering and diagnosing outdoor lighting networks. Starsense is based on two-way wireless communication using the latest in mesh network technology. This option gives ON/OFF and full dimming control of the luminaires. Complete with a decorative cap made of polycarbonate with a plastic lens. Allows a 90 degree rotation. Color of cap is grey.

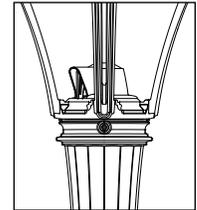

**SPCD** installed on luminaire

#### Motion Response

Tenon mount motion response provides 270° coverage on an adjustable knuckle. The coverage equals to up to 6 times the sensor height. It is an option offered jointly with the Dynadimmer OVR option, that can bring the light up to 100% when the motion response is triggered. It is available in a single or double mounting option. Finish options for the motion response device are white or dark gray. Finish options for the tenon must be specified to match the luminaire and pole. The tenon mount is fully rotatable 360°. This option is available for a 4" OD x 4" long tenon. See instruction sheet for time setting functionality (12 second to 16 minute turn off options) and for mounting instructions.

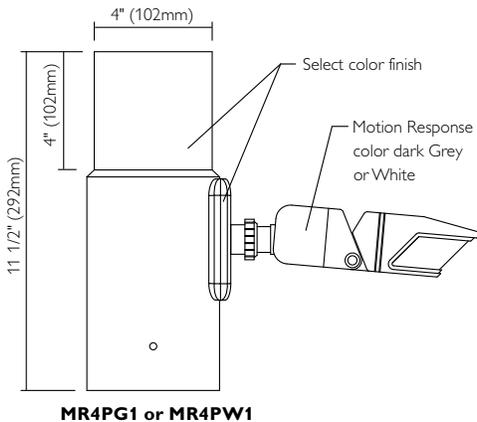

**MR4PG1 or MR4PW1**

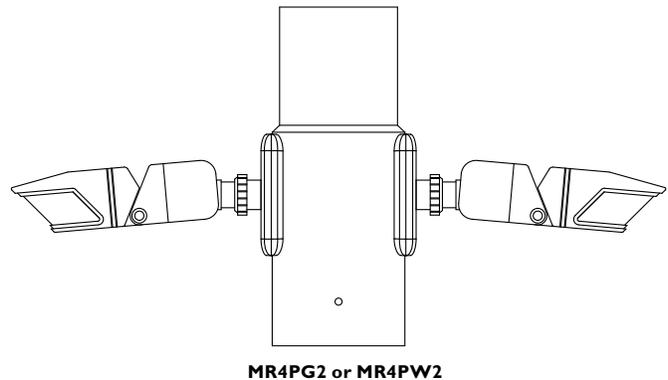

**MR4PG2 or MR4PW2**



# METROSCAPE LED POST-TOP URBAN LUMINAIRE

## Specifications (continued)

### Finish:

Color to be in accordance with the AAMA 2603 standard. Application of polyester powder coat paint (4 mils/100 microns) with  $\pm 1$  mils/24 microns of tolerance. The Thermosetting resins provides a discoloration resistant finish in accordance with the ASTM D2244 standard, as well as luster retention in keeping with the ASTM D523 standard and humidity proof in accordance with the ASTM D2247 standard.

The surface treatment achieves a minimum of 2000 hours for salt spray resistant finish in accordance with testing performed and per ASTM B117 standard.

Available options:

<b>BE2TX:</b>	Textured Midnight Blue
<b>BE6TX:</b>	Textured Ocean Blue
<b>BE8TX:</b>	Textured Royal Blue
<b>BG2TX:</b>	Textured Sandstone
<b>BKTX:</b>	Textured Black
<b>BRTX:</b>	Textured Bronze
<b>GN4TX:</b>	Textured Blue Green
<b>GN6TX:</b>	Textured Forest Green
<b>GN8TX:</b>	Textured Dark Forest Green
<b>GNTX:</b>	Textured Green
<b>GR:</b>	Gray Sandtex
<b>GY3TX:</b>	Textured Medium Grey
<b>NP:</b>	Natural Aluminum
<b>RD2TX:</b>	Textured Burgundy
<b>RD4TX:</b>	Textured Scarlet
<b>TG:</b>	Hammertone Gold
<b>TS:</b>	Hammertone Silver
<b>WHTX:</b>	Textured White

### LED products manufacturing standard

The electronic components sensitive to electrostatic discharge (ESD) such as light emitting diodes (LEDs) are assembled in compliance with IEC61340 5 1 and ANSI/ESD S20.20 standards so as to eliminate ESD events that could decrease the useful life of the product.

### Quality Control:

Manufactured to ISO 9001 2008 and ISO 14001 2004 International Quality Standards Certification.

### Vibration Resistance:

Meets the ANSI C136.31, American National Standard for Roadway Luminaire Vibration specifications for Bridge/overpass applications. (Tested for 3G over 100 000 cycles by an independent lab)

### Certifications and Compliance:

CSA, cULus Listed for Canada and USA.  
MetroScape is on the DesignLights Consortium (DLC) Qualified Products List (QPL).



## LED Wattage and Lumen Values - MetroScape Post Top MPTR Luminaire

LED = Philips Lumileds LUXEON T, CRI = 70, CCT = 4000K (+/- 350K)

System (LED + driver) rated life = 100,000 hrs<sup>9</sup>/ 90,000 hrs<sup>10</sup>

LED Module	Typical delivered lumens	Typical system wattage (W) <sup>11</sup>	Typical System Current (A) @				LED current (mA)	HID <sup>12</sup> equivalent	Luminaire Efficacy Rating (Lm/W)	BUG rating
			120V	208V	240V	277V				
16W16LED4K-T-LE3	1691	20	0.170	0.105	0.096	0.090	350	50-70	84.6	B0-U0-G0
16W16LED4K-T-LE2	1704	20	0.170	0.105	0.096	0.090	350	50-70	85.2	B1-U0-G0
16W16LED4K-T-LE3W	1704	20	0.170	0.105	0.096	0.090	350	50-70	85.2	B0-U0-G1
16W16LED4K-T-LE4	1704	20	0.170	0.105	0.096	0.090	350	50-70	85.2	B0-U0-G0
16W16LED4K-T-LE5	1704	20	0.170	0.105	0.096	0.090	350	50-70	85.2	B1-U0-G0
24W16LED4K-T-LE2	2363	29	0.247	0.147	0.131	0.120	530	70-100	81.5	B1-U0-G1
24W16LED4K-T-LE3	2363	29	0.247	0.147	0.131	0.120	530	70-100	81.5	B1-U0-G1
24W16LED4K-T-LE3W	2363	29	0.247	0.147	0.131	0.120	530	70-100	81.5	B1-U0-G1
24W16LED4K-T-LE4	2363	29	0.247	0.147	0.131	0.120	530	70-100	81.5	B1-U0-G1
24W16LED4K-T-LE5	2363	29	0.247	0.147	0.131	0.120	530	70-100	81.5	B2-U0-G1
30W16LED4K-T-LE3	2979	38	0.324	0.189	0.167	0.148	700	70-100	78.4	B1-U0-G1
30W16LED4K-T-LE2	3000	38	0.324	0.189	0.167	0.148	700	70-100	78.9	B1-U0-G1
30W16LED4K-T-LE3W	3000	38	0.324	0.189	0.167	0.148	700	70-100	78.9	B1-U0-G1
30W16LED4K-T-LE4	3000	38	0.324	0.189	0.167	0.148	700	70-100	78.9	B1-U0-G1
30W16LED4K-T-LE5	3000	38	0.324	0.189	0.167	0.148	700	70-100	78.9	B2-U0-G1
35W32LED4K-T-LE2	3318	37	0.312	0.190	0.173	0.162	350	70-100	89.7	B1-U0-G1

9. L<sub>70</sub> = 100,000 hrs (at ambient temperature = 25°C and forward current = 700 mA)

10. L<sub>70</sub> = 90,000 hrs (at ambient temperature = 25°C and forward current = 1050 mA)

11. System wattage includes the lamp and the LED driver.

12. Equivalence should always be confirmed by a photometric layout.

**Note:** Due to rapid and continuous advances in LED technology, LED luminaire data is subject to change without notice and at the discretion of Philips.

# METROSCAPE LED POST-TOP URBAN LUMINAIRE

## LED Wattage and Lumen Values - MetroScape Post Top MPTR Luminaire (continued)

LED = Philips Lumileds LUXEON T, CRI = 70, CCT = 4000K (+/- 350K)  
System (LED + driver) rated life = 100,000 hrs<sup>9</sup> / 90,000 hrs<sup>10</sup>

LED Module	Typical delivered lumens	Typical system wattage (W) <sup>11</sup>	Typical System Current (A) @				LED current (mA)	HID <sup>12</sup> equivalent	Luminaire Efficacy Rating (Lm/W)	BUG rating
			120V	208V	240V	277V				
35W32LED4K-T-LE3W	3318	37	0.312	0.190	0.173	0.162	350	70-100	89.7	B1-U0-G1
35W32LED4K-T-LE4	3318	37	0.312	0.190	0.173	0.162	350	70-100	89.7	B1-U0-G1
35W32LED4K-T-LE5	3318	37	0.312	0.190	0.173	0.162	350	70-100	89.7	B2-U0-G1
35W32LED4K-T-LE3	3318	37	0.312	0.190	0.173	0.162	350	70-100	89.7	B1-U0-G1
48W16LED4K-T-LE3	4036	55	0.465	0.263	0.228	0.198	1050	70-100	73.4	B1-U0-G1
48W16LED4K-T-LE2	4068	55	0.465	0.263	0.228	0.198	1050	70-100	74.0	B1-U0-G1
48W16LED4K-T-LE3W	4068	55	0.465	0.263	0.228	0.198	1050	70-100	74.0	B1-U0-G1
48W16LED4K-T-LE4	4068	55	0.465	0.263	0.228	0.198	1050	70-100	74.0	B1-U0-G1
48W16LED4K-T-LE5	4068	55	0.465	0.263	0.228	0.198	1050	70-100	74.0	B3-U0-G1
55W32LED4K-T-LE2	4602	55	0.465	0.274	0.244	0.220	530	100-150	83.7	B1-U0-G1
55W32LED4K-T-LE3	4602	55	0.465	0.274	0.244	0.220	530	100-150	83.7	B1-U0-G1
55W32LED4K-T-LE3W	4602	55	0.465	0.274	0.244	0.220	530	100-150	83.7	B1-U0-G1
55W32LED4K-T-LE4	4602	55	0.465	0.274	0.244	0.220	530	100-150	83.7	B1-U0-G1
55W32LED4K-T-LE5	4602	55	0.465	0.274	0.244	0.220	530	100-150	83.7	B3-U0-G1
55W48LED4K-T-LE3	4946	55	0.463	0.282	0.255	0.236	350	100-150	89.9	B1-U0-G1
55W48LED4K-T-LE2	4954	55	0.463	0.282	0.255	0.236	350	100-150	90.1	B1-U0-G1
55W48LED4K-T-LE3W	4954	55	0.463	0.282	0.255	0.236	350	100-150	90.1	B1-U0-G1
55W48LED4K-T-LE4	4954	55	0.463	0.282	0.255	0.236	350	100-150	90.1	B1-U0-G1
55W48LED4K-T-LE5	4954	55	0.463	0.282	0.255	0.236	350	100-150	90.1	B3-U0-G1
72W32LED4K-T-LE2	5840	73	0.616	0.356	0.313	0.280	700	100-150	80.0	B1-U0-G1
72W32LED4K-T-LE3W	5840	73	0.616	0.356	0.313	0.280	700	100-150	80.0	B1-U0-G2
72W32LED4K-T-LE4	5840	73	0.616	0.356	0.313	0.280	700	100-150	80.0	B1-U0-G1
72W32LED4K-T-LE5	5840	73	0.616	0.356	0.313	0.280	700	100-150	80.0	B3-U0-G1
72W32LED4K-T-LE3	5844	73	0.616	0.356	0.313	0.280	700	100-150	80.1	B1-U0-G1
70W64LED4K-T-LE2	6624	73	0.609	0.362	0.322	0.292	350	100-150	90.7	B1-U0-G1
70W64LED4K-T-LE3	6624	73	0.609	0.362	0.322	0.292	350	100-150	90.7	B1-U0-G2
70W64LED4K-T-LE3W	6624	73	0.609	0.362	0.322	0.292	350	100-150	90.7	B1-U0-G2
70W64LED4K-T-LE4	6624	73	0.609	0.362	0.322	0.292	350	100-150	90.7	B1-U0-G2
70W64LED4K-T-LE5	6624	73	0.609	0.362	0.322	0.292	350	100-150	90.7	B3-U0-G2
80W48LED4K-T-LE3	6859	81	0.675	0.399	0.353	0.319	530	150-200	84.7	B1-U0-G2
80W48LED4K-T-LE2	6863	81	0.675	0.399	0.353	0.319	530	150-200	84.7	B1-U0-G1
80W48LED4K-T-LE3W	6863	81	0.675	0.399	0.353	0.319	530	150-200	84.7	B1-U0-G2
80W48LED4K-T-LE4	6863	81	0.675	0.399	0.353	0.319	530	150-200	84.7	B1-U0-G2
80W48LED4K-T-LE5	6863	81	0.675	0.399	0.353	0.319	530	150-200	84.7	B3-U0-G2
97W32LED4K-T-LE3	7919	110	0.920	0.533	0.468	0.414	1050	150-200	72.0	B1-U0-G2
97W32LED4K-T-LE2	7920	110	0.920	0.533	0.468	0.414	1050	150-200	72.0	B2-U0-G1
97W32LED4K-T-LE3W	7920	110	0.920	0.533	0.468	0.414	1050	150-200	72.0	B1-U0-G2
97W32LED4K-T-LE4	7920	110	0.920	0.533	0.468	0.414	1050	150-200	72.0	B1-U0-G2
97W32LED4K-T-LE5	7920	110	0.920	0.533	0.468	0.414	1050	150-200	72.0	B3-U0-G2
90W80LED4K-T-LE2	8204	86	0.726	0.429	0.382	0.347	350	150-200	95.4	B2-U0-G1
90W80LED4K-T-LE3	8204	86	0.726	0.429	0.382	0.347	350	150-200	95.4	B1-U0-G2
90W80LED4K-T-LE3W	8204	86	0.726	0.429	0.382	0.347	350	150-200	95.4	B2-U0-G2
90W80LED4K-T-LE4	8204	86	0.726	0.429	0.382	0.347	350	150-200	95.4	B1-U0-G2
90W80LED4K-T-LE5	8204	86	0.726	0.429	0.382	0.347	350	150-200	95.4	B3-U0-G2
108W48LED4K-T-LE2	8715	107	0.896	0.519	0.457	0.407	700	200-250	81.4	B2-U0-G2
108W48LED4K-T-LE3W	8715	107	0.896	0.519	0.457	0.407	700	200-250	81.4	B2-U0-G2
108W48LED4K-T-LE4	8715	107	0.896	0.519	0.457	0.407	700	200-250	81.4	B1-U0-G2

9. L<sub>70</sub> = 100,000 hrs (at ambient temperature = 25°C and forward current = 700 mA)

10. L<sub>70</sub> = 90,000 hrs (at ambient temperature = 25°C and forward current = 1050 mA)

11. System wattage includes the lamp and the LED driver.

12. Equivalence should always be confirmed by a photometric layout.

**Note:** Due to rapid and continuous advances in LED technology, LED luminaire data is subject to change without notice and at the discretion of Philips.

# METROSCAPE LED POST-TOP URBAN LUMINAIRE

## LED Wattage and Lumen Values - MetroScape Post Top MPTR Luminaire (continued)

LED = Philips Lumileds LUXEON T, CRI = 70, CCT = 4000K (+/- 350K)  
System (LED + driver) rated life = 100,000 hrs<sup>9</sup> / 90,000 hrs<sup>10</sup>

LED Module	Typical delivered lumens	Typical system wattage (W) <sup>11</sup>	Typical System Current (A) @				LED current (mA)	HID <sup>12</sup> equivalent	Luminaire Efficacy Rating (Lm/W)	BUG rating
			120V	208V	240V	277V				
108W48LED4K-T-LE5	8715	107	0.896	0.519	0.457	0.407	700	200-250	81.4	B3-U0-G2
108W48LED4K-T-LE3	8719	107	0.896	0.519	0.457	0.407	700	200-250	81.5	B1-U0-G2
110W64LED4K-T-LE3	9167	105	0.879	0.512	0.449	0.400	530	200-250	87.3	B2-U0-G2
110W64LED4K-T-LE2	9169	105	0.879	0.512	0.449	0.400	530	200-250	87.3	B2-U0-G2
110W64LED4K-T-LE3W	9169	105	0.879	0.512	0.449	0.400	530	200-250	87.3	B2-U0-G2
110W64LED4K-T-LE4	9169	105	0.879	0.512	0.449	0.400	530	200-250	87.3	B2-U0-G2
110W64LED4K-T-LE5	9169	105	0.879	0.512	0.449	0.400	530	200-250	87.3	B3-U0-G2
135W80LED4K-T-LE2	11313	132	1.105	0.639	0.561	0.498	530	250-320	85.7	B2-U0-G2
135W80LED4K-T-LE3	11362	132	1.105	0.639	0.561	0.498	530	250-320	86.1	B2-U0-G2
135W80LED4K-T-LE4	11362	132	1.105	0.639	0.561	0.498	530	250-320	86.1	B2-U0-G2
135W80LED4K-T-LE3W	11769	132	1.105	0.639	0.561	0.498	530	250-320	89.2	B2-U0-G2
140W48LED4K-T-LE3	11803	162	1.355	0.772	0.672	0.589	1050	250-320	72.9	B2-U0-G2
140W48LED4K-T-LE2	11806	162	1.355	0.772	0.672	0.589	1050	250-320	72.9	B2-U0-G2
140W48LED4K-T-LE3W	11806	162	1.355	0.772	0.672	0.589	1050	250-320	72.9	B2-U0-G2
140W48LED4K-T-LE4	11806	162	1.355	0.772	0.672	0.589	1050	250-320	72.9	B2-U0-G2
140W48LED4K-T-LE5	11806	162	1.355	0.772	0.672	0.589	1050	250-320	72.9	B4-U0-G2
135W80LED4K-T-LE5	11817	132	1.105	0.639	0.561	0.498	530	250-320	89.5	B4-U0-G2

9. L<sub>70</sub> = 100,000 hrs (at ambient temperature = 25°C and forward current = 700 mA)

10. L<sub>70</sub> = 90,000 hrs (at ambient temperature = 25°C and forward current = 1050 mA)

11. System wattage includes the lamp and the LED driver.

12. Equivalence should always be confirmed by a photometric layout.

**Note:** Due to rapid and continuous advances in LED technology, LED luminaire data is subject to change without notice and at the discretion of Philips.



© 2014 Koninklijke Philips N.V. All rights reserved.  
Specifications are subject to change without notice.  
[www.philips.com/luminaires](http://www.philips.com/luminaires)

MetroScape MPTR Spec 06/14 page 7 of 7

Philips Lighting  
North America Corporation  
200 Franklin Square Drive  
Somerset, NJ 08873  
Phone: 855-486-2216

Imported by: Philips Lighting,  
a division of Philips Electronics Ltd.  
281 Hillmount Rd,  
Markham, ON Canada L6C 2S3  
Tel. 800-668-9008

# Compact Design, without compromise in performance

## MINIVIEW LED ROADWAY LUMINAIRE

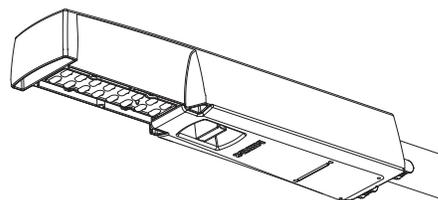

### PHILIPS LUMEC MINIVIEW LED ROADWAY LUMINAIRE

The Philips Lumecc MiniView LED Roadway luminaire was designed to eliminate the compromises of performance, features and value when choosing between existing HID and industry leading LED technology. MiniView is the perfect solution when projects require a luminaire that meets specifications without sacrificing performance... all while maximizing operations and maintenance savings. This roadway luminaire features a single IP66-rated LED module, designed to provide crisp, brilliant white light that surpasses existing HID luminaire performance. Optimized for applications such as local roads and residential streets, MiniView will become the choice of any city, municipality and utility considering the overall size, weight, and tool-free features that ensure ease of installation. MiniView makes your upgrade to reliable, long-lasting, low-maintenance LED lighting a simple cost-effective decision.

Project: \_\_\_\_\_  
 Location: \_\_\_\_\_  
 Catalog No: \_\_\_\_\_  
 Fixture Type: \_\_\_\_\_  
 Mfg: \_\_\_\_\_ Lamps: \_\_\_\_\_ Qty: \_\_\_\_\_  
 Notes: \_\_\_\_\_

### Ordering guide

example: SVS-35W16LED4K-T-LE3-UNIV-DMG-RC-WC10-GY3

Luminaire	LED Module	Optical System	Voltage	Integrated Features	Finish
<b>SVS</b>			<b>UNIV</b>	<b>DMG-RC-WC10</b>	<b>GY3</b>
SVS MiniView LED Roadway Luminaire	25W16LED4K-T or 35W16LED4K-T or 54W16LED4K-T	LE2 Type II LE3 Type III	UNIV 120-277VAC	DMG <sup>1</sup> Dimmable driver 0-10V RC <sup>1,2</sup> Receptacle for a twist-lock photocell or shorting cap WC10 <sup>1</sup> 10-year limited warranty	GY3 Grey finish

### Ordering guide

#### Luminaire Accessories - must be ordered as separate line items:

- ACC-SVS-HS<sup>3</sup>: House side shield
- ACC-SVS-UNIV-PH8<sup>2,3</sup>: Photoelectric cell
- ACC-SVS-PH9<sup>2,3</sup>: Shorting cap
- ACC-SVS-UNIV-SPC<sup>3</sup>: Starsense Photocell Control

1. Please note that these integrated features always come with MiniView luminaires.
2. Use of photoelectric cell or shorting cap is required to ensure proper illumination.
3. Please note that these accessories need to be ordered as separate line items and they are quickly and easily installed in the field.



**PHILIPS  
LUMEC**

# MINIVIEW LED ROADWAY LUMINAIRE

## LED Wattage and Lumen Values - MiniView Luminaire

LED = Philips Lumileds LUXEON T, CRI = 70, CCT = 4000K (+/- 350K)  
System (LED + driver) rated life = 100,000 hrs<sup>4</sup>

LED Module	Typical delivered lumens	Typical system wattage (W) <sup>5</sup>	Typical System Current (A) @				LED current (mA)	HID <sup>6</sup> equivalent	Luminaire Efficacy Rating (Lm/W)	BUG rating
			120V	208V	240V	277V				
25W16LED4K-T-LE2	2887	24	0.205	0.119	0.104	0.092	470	70-100W	118.7	B1-U0-G1
25W16LED4K-T-LE3	2752	24	0.205	0.119	0.104	0.092	470	70-100W	113.2	B1-U0-G1
35W16LED4K-T-LE2	4030	36	0.307	0.175	0.152	0.133	700	70-100W	111.9	B1-U0-G1
35W16LED4K-T-LE3	3842	36	0.307	0.175	0.152	0.133	700	70-100W	106.7	B1-U0-G1
54W16LED4K-T-LE2	5550	54	0.459	0.268	0.232	0.203	1050	100-150W	102.4	B1-U0-G1
54W16LED4K-T-LE3	5268	54	0.459	0.268	0.232	0.203	1050	100-150W	96.9	B1-U0-G1

4.  $L_{70} > 100,000$  hrs (at ambient temperature = 40°C and forward current = 1.05A).  
5. System wattage or total luminaire wattage includes the LED module and the LED driver.  
6. Equivalence should always be confirmed by a photometric layout.

Note: Due to rapid and continuous advances in LED technology, LED luminaire data is subject to change without notice and at the discretion of Philips.

## Dimensions - Standard MiniView Luminaire

Top View

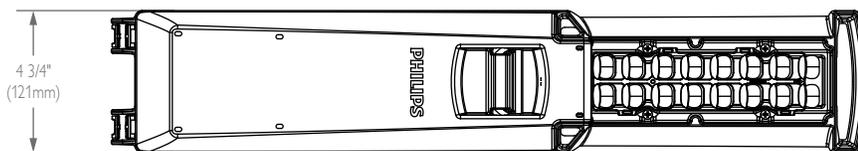

EPA: 0.85 sq. ft.

Luminaire Weight: 25/35W: 7.5 lbs. (3.4 kg)  
54W: 8.1 lbs. (3.7 kg)

Side View

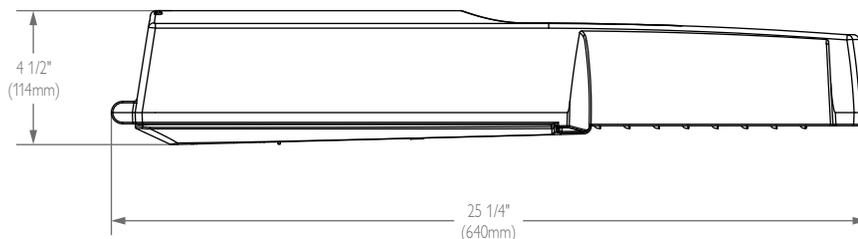

## LED Performance

PREDICTED LUMEN DEPRECIATION DATA <sup>7</sup>				
Ambient Temperature °C	Driver mA	Calculated $L_{70}$ Hours <sup>7,8</sup>	$L_{70}$ Per TM-21 <sup>8,9</sup>	Lumen Maintenance % @ 60,000 hours
Up to 40 °C	Up to 1050 mA	> 100,000 Hours	> 60,000 Hours	>96%

7. Predicted performance derived from LED manufacturer's data and engineering design estimates, based on IESNA LM-80 methodology. Actual experience may vary due to field application conditions.  
8.  $L_{70}$  is the predicted time when LED performance depreciates to 70% of initial lumen output.  
9. Calculated per IESNA TM21-11. Published  $L_{70}$  hours limited to 6 times actual LED test hours.

## Specifications

### Housing:

Made of low copper die cast A360 Aluminum alloy 0.100" (2.5mm) minimum thickness. Fits on a 1.66" (42mm) O.D. (1.25" NPS) or 2 3/8" (60mm) O.D. (2" NPS) by 5 1/4" (133mm) minimum long tenon. Comes with a zinc plated clamp fixed by 2 zinc plated hexagonal bolts 3/8 16 UNC for ease of installation. Provides an easy step adjustment of +/- 5° tilt in 2.5° increments. A quick release, tool less entry, hinged, removable polymeric door opens downward to provide access to electronic components and to a terminal block. Door is secured to prevent accidental dropping or disengagement. A clearance of 8" (203mm) at the rear is required in order to open the door. Complete with a bird guard protecting against birds and similar intruders and an ANSI label to identify wattage and source (both included in box).

### Light Engine:

Composed of 4 main components: LED Module / Optical System / Heat Sink / Driver.

Electrical components are RoHS compliant, IP66 sealed light engine equipped with Philips Lumileds LUXEON T LEDs.

LEDs tested by ISO 17025-2005 accredited lab in accordance with IESNA LM-80 guidelines in compliance with EPA ENERGY STAR, extrapolations in accordance with IESNA TM-21. Metal core board ensures greater heat transfer and longer lifespan.

### LED Module:

(Included), LED type Philips Lumileds LUXEON T. Composed of 16 high-performance white LEDs. Color temperature as per ANSI bin 4000 Kelvin nominal (3985K +/- 275K), CRI 70 Min. 75 Typical.

### Optical System:

Composed of high-performance optical grade polymer acrylic refractor lenses to achieve desired distribution optimized to get maximum spacing, target lumens and a superior lighting uniformity. System is rated IP66. Performance shall be tested per LM-63, LM-79 and TM-15 (IESNA) certifying its photometric performance. Dark Sky compliant with 0% uplight and U0 per IESNA TM-15.

**LE2 TYPE II** Asymmetrical Distribution

**LE3 TYPE III** Asymmetrical Distribution

### Heat Sink:

Built-in the housing, the innovative high efficacy heat sink chimney design ensures superior cooling by natural convection air flow pattern always close to LEDs and driver optimizing their efficiency and life. Product does not use any cooling device with moving parts (only passive cooling).

Entire luminaire is rated for operation in ambient temperature of -40°C / -40°F up to +40°C / +104°F.

### Driver:

For 25W and 35W: High power factor of >95%. Electronic driver, operating range 50/60 Hz. Auto-adjusting universal voltage input from 120 to 277 VAC rated for both application line to line or line to neutral, Class II, THD of 12% max.

For 54W: High power factor of 95%. Electronic driver, operating range 50/60 Hz. Auto-adjusting universal voltage input from 120 to 277 VAC rated for both application line to line or line to neutral, Class II, THD of 20% max

The current supplying the LEDs will be reduced by the driver if the driver experiences internal overheating as a protection to the LEDs and the electrical components. Output is protected from short circuits, voltage overload and current overload. Automatic recovery after correction. Standard built-in driver surge protection of 2.5kV (min).

### Integrated Features:

#### RC

Receptacle for a twist-lock photocell or shorting cap. Use of photocell or shorting cap is required to ensure proper illumination.

#### DMG

Dimmable driver 0-10V

#### WC10

MiniView is covered by a 10-year warranty from defects in material and workmanship in its intended use, as well as coverage for the finish. Visit website for more details on warranty.

#### SP1

Surge protection device tested in accordance with ANSI/IEEE C62.45 per ANSI/IEEE C62.41.2 Scenario I Category C High Exposure 10kV/10kA waveforms for Line-Ground, Line-Neutral and Neutral-Ground, and in accordance with DOE MSSLC Model Specification for LED Roadway Luminaires Appendix D Electrical Immunity High test level 10kV/10kA.

*Please note that these integrated features always come with MiniView luminaire.*

### Luminaire Accessories:

#### ACC-SVS-HS

House side shield

#### ACC-SVS-UNIV-PH8\*

Photoelectric cell

#### ACC-SVS-PH9\*

Shorting Cap

#### ACC-SVS-UNIV-SPC\*

Starsense Photo-cell Control.

*\* Luminaire option RC is required with this accessory.*

*These accessories need to be ordered as separate line items and they are quickly and easily installed in the field.*

### Luminaire Useful Life:

Refer to IES files for energy consumption and delivered lumens for each option. Based on ISTMT in situ thermal testing in accordance with UL1598 and UL8750, Philips Advance data and Philips Lumileds LM-80/TM-21 data, expected to reach 100,000+ hours with >L<sub>70</sub> lumen maintenance @ 40°C.

### Wiring:

The connection of the luminaire is done using a terminal block connector 600V, 85A for use with #2-14 AWG. wires from the primary circuit, located inside the housing.

### Hardware:

All exposed screws shall be stainless steel with Ceramic primer-seal base coat to reduce seizing of the parts. All seals and sealing devices are made and/or lined with EPDM and/or silicone and/or rubber.

## Specifications

### Finish:

Color to be medium grey (GY3) and in accordance with the AAMA 2603 standard. Application of a polyester powdercoat paint (4 mils/100 microns) with  $\pm 1$  mils/24 microns of tolerance. The Thermosetting resins provides a discoloration resistant finish in accordance with the ASTM-D2244 standard, as well as luster retention in keeping with the ASTM-D523 standard and humidity proof in accordance with the ASTM-D2247 standard.

The surface treatment achieves a minimum of 2000 hours for salt spray resistant finish in accordance with testing performed and per ASTM-B117 standard.

### LED Products Manufacturing Standard:

The electronic components sensitive to electrostatic discharge (ESD) such as light emitting diodes (LEDs) are assembled in compliance with IEC61340-5-1 and ANSI/ESD S20.20 standards so as to eliminate ESD events that could decrease the useful life of the product.

### Vibration Resistance:

The SVS meets the ANSI C136.31, American National Standard for Roadway Luminaire Vibration specifications for Bridge/overpass applications. (Tested for 3G over 100 000 cycles by an independent lab).

### Certifications and Compliance:

CSA, cULus Listed for Canada and USA. Luminaire complies with DOE MSSL Model Specification for LED Roadway Luminaires. MiniView is on the DesignLights Consortium (DLC) Qualified Products List (QPL).



**PHILIPS  
LUMEC**

Roadway

RoadFocus

145, 180, 215 and 241W RFL



Project: \_\_\_\_\_  
 Location: \_\_\_\_\_  
 Cat.No: \_\_\_\_\_  
 Type: \_\_\_\_\_  
 Lamps: \_\_\_\_\_ Qty: \_\_\_\_\_  
 Notes: \_\_\_\_\_

The Philips Lumece RoadFocus LED Cobra Head luminaires feature a sleek design that provides seamless replacement of existing HID luminaires. RoadFocus is available in three sizes, offers multiple lumen packages, and a complete array of optical distributions, making it an outstanding solution for all types of roadway applications.

**Ordering guide**

**Example:** RFL-145W64LED4K-T-R2S-UNIV-DMG-OTL-RCD7-SP2-WC10-GY3

Luminaire	LED Module	Optical System	Voltage	Driver and Dimming	Wattage Switch	Twist-Lock Receptacle	Surge Protection	Warranty	Finish
<input type="text" value="RFL"/>	<input type="text"/>	<input type="text"/>	<input type="text"/>	<input type="text"/>	<input type="text"/>	<input type="text"/>	<input type="text"/>	<input type="text" value="WC10"/>	<input type="text"/>
RFL RoadFocus Large	145W64LED4K-T or 180W80LED4K-T or 215W96LED4K-T or 241W112LED4K-T	R2S Type II Short R2M Type II Medium R3S Type III Short R3M Type III Medium 5 Type V	UNIV 120-277VAC HVU 347-480VAC	<i>Standard:</i> DMG <sup>1,6</sup> Dimmable driver 0-10V <i>Optional:</i> AMPD <sup>2,4,5,6</sup> Amplight Dimming DynaDimmer Economy Profile CDMGE25 <sup>2,4,5,6</sup> CDMGE50 <sup>2,4,5,6</sup> CDMGE75 <sup>2,4,5,6</sup> DynaDimmer Median Profile CDMGM25 <sup>2,4,5,6</sup> CDMGM50 <sup>2,4,5,6</sup> CDMGM75 <sup>2,4,5,6</sup> DynaDimmer Safety Profile CDMGS25 <sup>2,4,5,6</sup> CDMGS50 <sup>2,4,5,6</sup> CDMGS75 <sup>2,4,5,6</sup> DALI <sup>2,4,5,6</sup> Digitally Addressable Lighting Interface DMG-AST <sup>*2,4</sup> Adjustable Startup Time DMG-CLO <sup>*2,4,5</sup> Constant Light Output DMG-OTL <sup>*2,4</sup> Over The Life <i>*Includes 0-10v Dimming</i>	FAWS <sup>5</sup> Field Adjustable Wattage Selector (optional)	<i>Standard:</i> RCD <sup>1,3,7</sup> Receptacle for twist-lock photocell or shorting cap, 5-pin (standard) <i>Optional:</i> RCD7 <sup>3,7</sup> Receptacle for twist-lock photocell or shorting cap, 7-pin (optional)	SP2 <sup>8</sup> 20kV / 20kA Surge Protector (optional)	WC10 <sup>1</sup> 10-year limited warranty (standard)	BK Black Finish BR Bronze Finish GY3 Gray Finish WH White Finish

1. Please note these integrated features come standard with RoadFocus luminaires.  
 2. Denotes programmable driver option. Not available with HVU (347-480volt).

3. Use of photoelectric cell or shorting cap is required to ensure proper illumination.  
 4. Not available with HVU (347-480volt).  
 5. FAWS not available with AMPD, CDMG options, DALI or CLO.  
 6. Dimming choices: Select either DMG or AMPD or one of the CDMG options or DALI.

7. When RCD7 option is selected you will get 7-pin instead of standard RCD 5-pin.  
 8. When SP2 option is selected you will get SP2 instead of standard SP1.





# RFL RoadFocus LED Cobrahead, Large

145, 180, 215, and 241W

**Accessories** (must be ordered as separate line items – quickly and easily installed in the field)

<p><b>ACC-RFS-RFM-RFL-PH9<sup>9</sup></b> Shorting cap</p> <p><b>ACC-RFS-RFM-RFL-HS</b> House side shield, 1 per 16 LED light engine.</p> <p><b>ACC-RFS-RFM-RFL-UNIV-PH8<sup>9</sup></b> Twist-lock Photoelectric Cell, UNIV (120-277VAC).</p> <p><b>ACC-RFM-RFL-PH8/347<sup>9</sup></b> Twist-lock Photoelectric Cell, HVU 347VAC.</p> <p><b>ACC-RFM-RFL-PH8/480<sup>9</sup></b> Twist-lock Photoelectric Cell, HVU 480VAC.</p> <p><b>ACC-RFS-RFM-RFL-UNIV-PH8XL<sup>9</sup></b> Twist-lock Photoelectric Cell, extended life, UNIV (120-277VAC).</p>	<p><b>ACC-RFS-RFM-RFL-UNIV-SPC<sup>9,10</sup></b> Starsense twist-lock photoelectric cell &amp; antenna node, UNIV (120-277VAC).</p> <p><b>ACC-RFM-RFL-HVU-SPC<sup>9,10</sup></b> Starsense twist-lock photoelectric cell &amp; antenna node, HVU (347-480VAC).</p> <p><b>ACC-RFS-RFM-RFL-UNIV-SPCD<sup>9,10</sup></b> Starsense dimmable twist-lock photoelectric cell &amp; antenna node, UNIV (120-277VAC).</p>
--	--

9. Use of photoelectric cell or shorting cap is required to ensure proper illumination.

10. Please note that more hardware as well as software are required – please contact the quotations department for help with putting together the entire control system.

## LED Wattage and Lumen Values

LED = Philips Lumileds LUXEON T, CRI = 70, CCT = 4000K (+/- 350K)

System (LED + driver) rated life = 100,000 hrs<sup>11</sup>

LED Module	Typical Delivered Lumens	Typical System Wattage (W) <sup>12</sup>	LED Current (mA)	Typical System Current (A) @						Efficacy (Lm/W)	BUG Rating
				120V	208V	240V	277V	347V	480V		
145W64LED4K-T-R2S	16,349	137	700	1.15	0.66	0.58	0.51	0.41	0.31	119	B3-U0-G2
145W64LED4K-T-R2M	16,046	137	700	1.15	0.66	0.58	0.51	0.41	0.31	117	B3-U0-G3
145W64LED4K-T-R3S	15,763	137	700	1.15	0.66	0.58	0.51	0.41	0.31	115	B2-U0-G3
145W64LED4K-T-R3M	15,697	137	700	1.15	0.66	0.58	0.51	0.41	0.31	115	B3-U0-G2
180W80LED4K-T-R2S	20,444	174	700	1.46	0.86	0.76	0.69	0.52	0.39	117	B3-U0-G2
180W80LED4K-T-R2M	20,065	174	700	1.46	0.86	0.76	0.69	0.52	0.39	115	B3-U0-G3
180W80LED4K-T-R3S	19,711	174	700	1.46	0.86	0.76	0.69	0.52	0.39	113	B2-U0-G3
180W80LED4K-T-R3M	19,628	174	700	1.46	0.86	0.76	0.69	0.52	0.39	113	B3-U0-G3
215W96LED4K-T-R2S	24,538	207	700	1.74	1.01	0.89	0.80	0.62	0.46	119	B3-U0-G2
215W96LED4K-T-R2M	24,084	207	700	1.74	1.01	0.89	0.80	0.62	0.46	116	B3-U0-G3
215W96LED4K-T-R3S	23,658	207	700	1.74	1.01	0.89	0.80	0.62	0.46	114	B3-U0-G4
215W96LED4K-T-R3M	23,559	207	700	1.74	1.01	0.89	0.80	0.62	0.46	114	B3-U0-G3
241W112LED4K-T-R2S	28,633	248	700	2.03	1.17	1.02	0.91	0.72	0.53	115	B4-U0-G3
241W112LED4K-T-R2M	28,102	248	700	2.03	1.17	1.02	0.91	0.72	0.53	114	B3-U0-G4
241W112LED4K-T-R3S	27,606	244	700	2.03	1.17	1.02	0.91	0.72	0.53	113	B3-U0-G4
241W112LED4K-T-R3M	27,490	244	700	2.03	1.17	1.02	0.91	0.72	0.53	113	B3-U0-G4

Type V (5) IES files for all LED modules pending.

11. L<sub>70</sub> >100,000 hrs (at ambient temperature = 25°C).

12. System wattage or total luminaire wattage includes the LED module and the LED driver.

Note: Due to rapid and continuous advances in LED technology, LED luminaire data is subject to change without notice and at the discretion of Philips.

# RFL RoadFocus LED Cobrahead, Large

145, 180, 215, and 241W

## Field Adjustable Wattage (FAWS) Multiplier Chart

FAWS Position	Typical Delivered Lumens Multiplier	Typical System wattage and typical current
1	0.37	0.29
2	0.55	0.50
3	0.62	0.58
4	0.71	0.69
5	0.77	0.75
6	0.81	0.81
7	0.84	0.87
8	0.94	0.91
9	0.98	0.96
10	1.00	1.00

## Dimensions

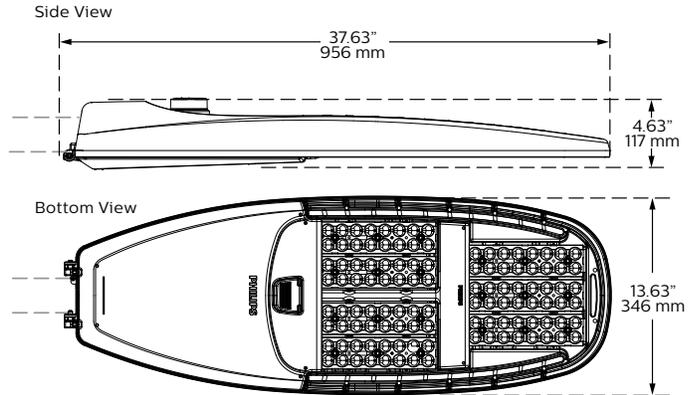

Weight: 27.3 Lbs  
EPA: 0.92 sq. ft.

## Predicted Lumen Depreciation Data<sup>14,15,16</sup>

Ambient Temperature °C	Driver mA	Calculated L <sub>70</sub> Hours	L <sub>70</sub> per TM-21	Lumen Maintenance % at 60,000 hrs
25°C	700 mA	>100,000 hours	>60,000 hours	>94%

14. Predicted performance derived from LED manufacturer's data and engineering design estimates, based on IESNA LM-80 methodology. Actual experience may vary due to field application conditions.

15. L<sub>70</sub> is the predicted time when LED performance depreciates to 70% of initial lumen output.

16. Calculated per IESNA TM21-11. Published L<sub>70</sub> hours limited to 6 times actual LED test hours

## Specifications

### Housing

Made of a low copper die cast Aluminum alloy (A360), 0.100" (2.5mm) minimum thickness. Fits on a 1.66" (42mm) O.D. (1.25" NPS), 1.9" (48mm) O.D. (1.5" NPS) or 2 3/8" (60mm) O.D. (2" NPS) by 5 1/2" (140mm) minimum long tenon. Comes with a zinc plated clamp fixed by 2 zinc plated hexagonal bolts 3/8 16 UNC for ease of installation. Provides an easy step adjustment of +/- 5° tilt in 2.5° increments. Includes integral bubble level standard (always included). A quick release, tool less entry, single latch, hinged, removable door opens downward to provide access to electronic components and to a terminal block. Door is secured to prevent accidental dropping or disengagement. A clearance of 13" (330mm) at the rear is required in order to remove the door. Complete with a bird guard protecting against birds and similar intruders and an ANSI label to identify wattage and source (both included in box). Housing (including electrical compartment) rated IP54 per ANSI C136.37.

### Light Engine

Composed of 4 main components: LED Module / Optical System / Heat Sink / Driver

Electrical components are RoHS compliant, IP66 sealed light engine equipped with Philips Lumileds LUXEON T LEDs. LEDs tested by ISO 17025-2005 accredited lab in accordance with IESNA LM-80 guidelines in compliance with EPA ENERGY STAR, extrapolations in accordance with IESNA TM-21. Metal core board ensures greater heat transfer and longer lifespan.

**LED Module** (Included), LED type Philips Lumileds LUXEON T. Composed of high performance white LEDs. Color temperature as per ANSI bin 4000 Kelvin nominal (3985K +/- 275K), CRI 70 Min. 75 Typical.

**Optical System:** Composed of high performance optical grade polymer refractor lenses to achieve desired distribution optimized to get maximum spacing, target lumens and a superior lighting uniformity. System is rated IP66. Performance shall be tested per LM-63, LM-79 and TM-15 (IESNA) certifying its photometric performance. Dark Sky compliant with 0% uplight and U0 per IESNA TM-15.

**Heat Sink:** Built in the housing, designed to ensure high efficacy and superior cooling by natural vertical convection air flow pattern always close to LEDs and driver optimising their efficiency and life. Product does not use any cooling device with moving parts (only passive cooling). Wide openings enable natural cleaning and removal of dirt and debris. Entire luminaire is rated for operation in ambient temperature of -40°C / -40°F up to +40°C / +104°F.

# RFL RoadFocus LED Cobrahead, Large

145, 180, 215, and 241W

## Specifications (continued)

**Driver:** High power factor of 90% min. Electronic driver, operating range 50/60 Hz. Auto adjusting universal voltage input from 120 to 277 or 347 to 480 VAC rated for both application line to line or line to neutral, Class I, THD of 20% max.

**(DMG), Dimming compatible 0-10 volts.**

The current supplying the LEDs will be reduced by the driver if the driver experiences internal overheating as a protection to the LEDs and the electrical components. Output is protected from short circuits, voltage overload and current overload. Automatic recovery after correction. Standard built in driver surge protection of 2.5kV (min).

### Integrated Features

**DMG:** Dimmable driver 0-10V.

**RCD\*:** Receptacle with 5 pins enabling dimming, can be used with a twist lock Starsense or photoelectric cell or a shorting cap.

**WC10:** 10-year limited warranty from defects in material and workmanship in its intended use, as well as coverage for finish. Visit website for more details.

**SP1:** Surge protection device tested in accordance with ANSI/IEEE C62.45 per ANSI/IEEE C62.41.2 Scenario I Category C High Exposure 10kV/10kA waveforms for Line-Ground, Line-Neutral and Neutral-Ground, and in accordance with DOE MSSLC Model Specification for LED Roadway Luminaires Appendix D Electrical Immunity High test level 10kV/10kA.

*Please note that these integrated features always come with RoadFocus luminaire.*

*\* Use of photoelectric cell or shorting cap is required to ensure proper illumination.*

### Driver and Luminaire Options

**AMPD\*:** Driver pre-programmed for compatibility with Amplit control system.

**AST\*:** Pre-set driver for progressive start-up of the LED module(s) to optimize energy management and enhance visual comfort at start-up.

**CLO\*:** Pre-set driver to manage the lumen depreciation by adjusting the power given to the LEDs offering the same lighting intensity during the entire lifespan of the LED module.

**DALI\*:** Pre-set driver compatible with the DALI control system.

**OTL\*:** Pre-set driver to signal end of life of the LED module(s) for better fixture management.

**CDMG\*:** Dynamimmer standard dimming functionalities including pre-programmed scenarios to suit many applications and needs from safety to maximum energy savings

### Safety Mode:

CDMG525: 4 hours, 25% power dimming

CDMG550: 4 hours 50% power dimming

CDMG575: 4 hours 75% power dimming

### Median Mode:

CDMG25: 6 hours 25% power dimming

CDMG50: 6 hours 50% power dimming

CDMG75: 6 hours 75% power dimming

### Economy Mode:

CDMG25: 8 hours 25% power dimming

CDMG50: 8 hours 50% power dimming

CDMG75: 8 hours 75% power dimming

*\*Not available with HVU (347-480V)*

**FAWS:** Field Adjustable Wattage Selector, pre-set to the highest position, can be easily switched in the field to the required position. This reduces total luminaire wattage consumption and reduces the light level – see the FAWS multiplier chart for more details. **NOTE:** When using FAWS with dimming, set the switch to position 10 (maximum output) to enable dimming.

**SP2:** 20kV / 20kA surge protection device that provides extra protection beyond the SP1 10kV/10kA level.

**RCD7\*:** Receptacle with 7 pins enabling dimming and additional functionality (to be determined), can be used with a twist lock Starsense node or photoelectric cell or a shorting cap.

*Please note: Additional hardware will be required to utilize the additional 2 pins on this receptacle.*

*\* Use of photoelectric cell or shorting cap is required to ensure proper illumination.*

### Luminaire Useful Life

Refer to IES files for energy consumption and delivered lumens for each option. Based on ISTMT in situ thermal testing in accordance with UL1598 and UL8750, Philips System Reliability Tool, Philips Advance data and Philips Lumileds LM-80/TM-21 data, expected to reach 100,000 + hours (72W32LED and 108W48LED at 700mA) or 94,500 hours (108W32LED and 160W48LED at 1050mA) with >L70 lumen maintenance @ 25°C. Luminaire Useful Life accounts for LED lumen maintenance AND all of these additional factors including: LED life, driver life, PCB substrate, solder joints, on/off cycles, burning hours and corrosion.

### Wiring

The connection of the luminaire is done using a terminal block connector 600V, 85A for use with #2 14 AWG. wires from the primary circuit, located inside the housing. Due to the inrush current that occurs with electronic drivers, recommend using a time delay or slow blow fuse to avoid unnecessary and unwanted fuse blowing that can occur with fast acting fuses.

### Hardware

All exposed screws shall be stainless steel with Ceramic primer seal basecoat to reduce seizing of the parts. All seals and sealing devices are made and/or lined with EPDM and/or silicone and/or rubber.

### Finish

Color in accordance with the AAMA 2603 standard. Application of polyester powder coat paint (4 mils/100 microns) with  $\pm$  1 mils/24 microns of tolerance. The Thermosetting resins provides a discoloration resistant finish in accordance with the ASTM D2244 standard, as well as luster retention in keeping with the ASTM D523 standard and humidity proof in accordance with the ASTM D2247 standard. The surface treatment achieves a minimum of 2000 hours for salt spray resistant finish in accordance with testing performed and per ASTM B117 standard.

### LED products manufacturing standard

The electronic components sensitive to electrostatic discharge (ESD) such as light emitting diodes (LEDs) are assembled in compliance with IEC61340-5-1 and ANSI/ESD S20.20 standards so as to eliminate ESD events that could decrease the useful life of the product.

### Vibration Resistance

The RFL meets the ANSI C136.31, American National Standard for Roadway Luminaire Vibration specifications for Bridge/overpass applications. (Tested for 3G over 100,000 cycles by an independent lab)

### Certifications and Compliance

cULus Listed for Canada and USA. Luminaire meets DOE and MSSLC Model Specification for LED Roadway Luminaires. RoadFocus LED Cobrahead luminaires are DesignLights Consortium qualified.

### Limited Warranty

10-year limited warranty. See philips.com/luminaires for details and restrictions.

### Brackets/Arms

For brackets / arms available with this luminaire, see Lumec 3D for details.



**PHILIPS  
LUMEC**

Roadway

RoadFocus

72, 108 and 160W RFM



Project: \_\_\_\_\_  
 Location: \_\_\_\_\_  
 Cat.No: \_\_\_\_\_  
 Type: \_\_\_\_\_  
 Lamps: \_\_\_\_\_ Qty: \_\_\_\_\_  
 Notes: \_\_\_\_\_

The Philips Lumec RoadFocus LED Cobra Head luminaires feature a sleek design that provides seamless replacement of existing HID luminaires. RoadFocus is available in three sizes, offers multiple lumen packages, and a complete array of optical distributions, making it an outstanding solution for all types of roadway applications.

**Ordering guide**

**Example: RFM-72W32LED4K-T-R2S-UNIV-DMG-AST-FAWS-RCD-SP2-WC10-GY3**

Luminaire	LED Module	Optical System	Voltage	Driver and Dimming	Wattage Switch	Twist-Lock Receptacle	Surge Protection	Warranty	Finish
<b>RFM</b>	<input type="text"/>	<input type="text"/>	<input type="text"/>	<input type="text"/>	<input type="text"/>	<input type="text"/>	<input type="text"/>	<b>WC10</b>	<input type="text"/>
<b>RFM</b> RoadFocus Medium	<b>72W32LED4K-T</b> or <b>108W32LED4K-T<sup>2,4</sup></b> or <b>108W48LED4K-T</b> or <b>160W48LED4K-T<sup>2,4</sup></b>	<b>R2S</b> Type II Short <b>R2M</b> Type II Medium <b>R3S</b> Type III Short <b>R3M</b> Type III Medium <b>5</b> Type V	<b>UNIV</b> 120-277VAC <b>HVU</b> 347-480VAC	<i>Standard:</i> <b>DMG<sup>1,6</sup></b> Dimmable driver 0-10V <i>Optional:</i> <b>AMPD<sup>2,4,5,6</sup></b> Amplight Dimming DynaDimmer Economy Profile <b>CDMG<sup>E25</sup>2,4,5,6</b> <b>CDMG<sup>E50</sup>2,4,5,6</b> <b>CDMG<sup>E75</sup>2,4,5,6</b> DynaDimmer Median Profile <b>CDMG<sup>M25</sup>2,4,5,6</b> <b>CDMG<sup>M50</sup>2,4,5,6</b> <b>CDMG<sup>M75</sup>2,4,5,6</b> DynaDimmer Safety Profile <b>CDMG<sup>S25</sup>2,4,5,6</b> <b>CDMG<sup>S50</sup>2,4,5,6</b> <b>CDMG<sup>S75</sup>2,4,5,6</b> <b>DALI<sup>2,4,5,6</sup></b> Digitally Addressable Lighting Interface <b>DMG-AST<sup>*2,4</sup></b> Adjustable Startup Time <b>DMG-CLO<sup>*2,4,5</sup></b> Constant Light Output <b>DMG-OTL<sup>*2,4</sup></b> Over The Life <i>*Includes 0-10v Dimming</i>	<b>FAWS<sup>5</sup></b> Field Adjustable Wattage Selector (optional)	<i>Standard:</i> <b>RCD<sup>1,3,7</sup></b> Receptacle for twist-lock photocell or shorting cap, 5-pin (standard) <i>Optional:</i> <b>RCD<sup>7,3,7</sup></b> Receptacle for twist-lock photocell or shorting cap, 7-pin (optional)	<b>SP2<sup>8</sup></b> 20kV / 20kA Surge Protector (optional)	<b>WC10<sup>1</sup></b> 10-year limited warranty (standard)	<b>BK</b> Black Finish <b>BR</b> Bronze Finish <b>GY3</b> Gray Finish <b>WH</b> White Finish

1. Please note these integrated features come standard with RoadFocus luminaires.  
 2. Denotes programmable driver option. Not available with HVU (347-480volt). Not available with 1050 mA versions (108W32LED, 160W48LED).

3. Use of photoelectric cell or shorting cap is required to ensure proper illumination.  
 4. Not available with HVU (347-480volt).  
 5. FAWS not available with AMPD, CDMG options, DALI or CLO.  
 6. Dimming choices: Select either DMG or AMPD or one of the CDMG options or DALI.

7. When RDC7 option is selected you will get 7-pin instead of standard RCD 5-pin.  
 8. When SP2 option is selected you will get SP2 instead of standard SP1.



# RFM RoadFocus LED Cobrahead, Medium

72, 108, and 160W

**Accessories** (must be ordered as separate line items - quickly and easily installed in the field)

<p><b>ACC-RFS-RFM-RFL-PH9<sup>9</sup></b> Shorting cap</p> <p><b>ACC-RFS-RFM-RFL-HS</b> House side shield, 1 per 16 LED light engine.</p> <p><b>ACC-RFS-RFM-RFL-UNIV-PH8<sup>9</sup></b> Twist-lock Photoelectric Cell, UNIV (120-277VAC).</p> <p><b>ACC-RFM-RFL-PH8/347<sup>9</sup></b> Twist-lock Photoelectric Cell, HVU 347VAC.</p> <p><b>ACC-RFM-RFL-PH8/480<sup>9</sup></b> Twist-lock Photoelectric Cell, HVU 480VAC.</p> <p><b>ACC-RFS-RFM-RFL-UNIV-PH8XL<sup>9</sup></b> Twist-lock Photoelectric Cell, extended life, UNIV (120-277VAC).</p>	<p><b>ACC-RFS-RFM-RFL-UNIV-SPC<sup>9,10</sup></b> Starsense twist-lock photoelectric cell &amp; antenna node, UNIV (120-277VAC).</p> <p><b>ACC-RFM-RFL-HVU-SPC<sup>9,10</sup></b> Starsense twist-lock photoelectric cell &amp; antenna node, HVU (347-480VAC).</p> <p><b>ACC-RFS-RFM-RFL-UNIV-SPCD<sup>9,10</sup></b> Starsense dimmable twist-lock photoelectric cell &amp; antenna node, UNIV (120-277VAC).</p>
--	--

9. Use of photoelectric cell or shorting cap is required to ensure proper illumination.

10. Please note that more hardware as well as software are required - please contact the quotations department for help with putting together the entire control system.

## LED Wattage and Lumen Values

LED = Philips Lumileds LUXEON T, CRI = 70, CCT = 4000K (+/- 350K)

System (LED + driver) rated life = 100,000 hrs<sup>11</sup>

LED Module	Typical Delivered Lumens	Typical System Wattage (W) <sup>12</sup>	LED Current (mA)	Typical System Current (A) @						Efficacy (Lm/W)	BUG Rating
				120V	208V	240V	277V	347V	480V		
72W32LED4K-T-R2S	8,330	73	700	0.62	0.36	0.31	0.28	0.21	0.15	114	B2-U0-G1
72W32LED4K-T-R2M	8,140	73	700	0.62	0.36	0.31	0.28	0.21	0.15	112	B2-U0-G2
72W32LED4K-T-R3S	8,085	73	700	0.62	0.36	0.31	0.28	0.21	0.15	111	B1-U0-G2
72W32LED4K-T-R3M	8,178	73	700	0.62	0.36	0.31	0.28	0.21	0.15	112	B2-U0-G2
108W32LED4K-T-R2S	11,169	108	1050	0.91	0.53	0.47	0.41	N/A		103	B2-U0-G2
108W32LED4K-T-R2M	10,914	108	1050	0.91	0.53	0.47	0.41			101	B2-U0-G2
108W32LED4K-T-R3S	10,841	108	1050	0.91	0.53	0.47	0.41			100	B1-U0-G1
108W32LED4K-T-R3M	10,965	108	1050	0.91	0.53	0.47	0.41			102	B2-U0-G2
108W48LED4K-T-R2S	12,507	106	700	0.93	0.53	0.46	0.40	0.32	0.23	118	B3-U0-G2
108W48LED4K-T-R2M	12,222	106	700	0.93	0.53	0.46	0.40	0.32	0.23	115	B2-U0-G2
108W48LED4K-T-R3S	12,140	106	700	0.93	0.53	0.46	0.40	0.32	0.23	115	B2-U0-G2
108W48LED4K-T-R3M	12,279	106	700	0.93	0.53	0.46	0.40	0.32	0.23	116	B2-U0-G2
160W48LED4K-T-R2S	16,778	161	1050	1.34	0.76	0.66	0.58	N/A		104	B3-U0-G2
160W48LED4K-T-R2M	16,396	161	1050	1.34	0.76	0.66	0.58			102	B3-U0-G3
160W48LED4K-T-R3S	16,285	161	1050	1.34	0.76	0.66	0.58			101	B2-U0-G3
160W48LED4K-T-R3M	16,472	161	1050	1.34	0.76	0.66	0.58			102	B3-U0-G3

Type V (5) IES files for all LED modules pending.

11. L<sub>70</sub> >100,000 hrs (at ambient temperature = 25°C).

12. System wattage or total luminaire wattage includes the LED module and the LED driver.

Note: Due to rapid and continuous advances in LED technology, LED luminaire data is subject to change without notice and at the discretion of Philips.

# RFM RoadFocus LED Cobrahead, Medium

72, 108, and 160W

## Field Adjustable Wattage (FAWS) Multiplier Chart

72W32LED4K-T or 108W48LED4K-T (700 mA)

FAWS Position	Typical Delivered Lumens Multiplier	Typical System wattage and typical current
1	0.37	0.29
2	0.55	0.50
3	0.62	0.58
4	0.71	0.69
5	0.77	0.75
6	0.81	0.81
7	0.84	0.87
8	0.94	0.91
9	0.98	0.96
10	1.00	1.00

108W32LED4K-T OR 160W48LED4K-T (1050mA)

FAWS Position	Typical Delivered Lumens Multiplier	Typical System wattage and typical current
1	0.33	0.27
2	0.56	0.48
3	0.64	0.57
4	0.71	0.65
5	0.79	0.74
6	0.84	0.79
7	0.89	0.85
8	0.92	0.90
9	0.96	0.95
10	1.00	1.00

## Dimensions

Side View

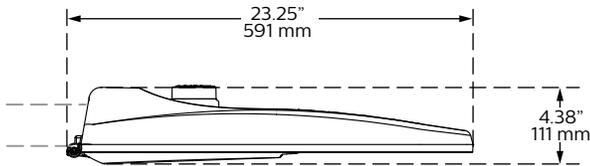

Bottom View

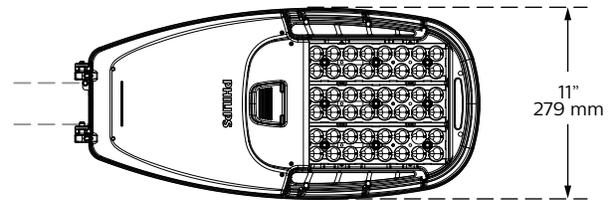

Weight: 12.2 Lbs  
EPA: 0.53 sq. ft.

## Predicted Lumen Depreciation Data<sup>14,15,16</sup>

Ambient Temperature °C	Driver mA	Calculated L <sub>70</sub> Hours	L <sub>70</sub> per TM-21	Lumen Maintenance % at 60,000 hrs
25°C	up to 1050 mA	>100,000 hours	>60,000 hours	>96%

14. Predicted performance derived from LED manufacturer's data and engineering design estimates, based on IESNA LM-80 methodology. Actual experience may vary due to field application conditions.

15. L<sub>70</sub> is the predicted time when LED performance depreciates to 70% of initial lumen output.

16. Calculated per IESNA TM21-11. Published L<sub>70</sub> hours limited to 6 times actual LED test hours

## Specifications

### Housing

Made of a low copper die cast Aluminum alloy (A360), 0.100" (2.5mm) minimum thickness. Fits on a 1.66" (42mm) O.D. (1.25" NPS), 1.9" (48mm) O.D. (1.5" NPS) or 2 3/8" (60mm) O.D. (2" NPS) by 5 1/2" (140mm) minimum long tenon. Comes with a zinc plated clamp fixed by 2 zinc plated hexagonal bolts 3/8 16 UNC for ease of installation. Provides an easy step adjustment of +/- 5° tilt in 2.5° increments. Includes integral bubble level standard (always included). A quick release, tool less entry, single latch, hinged, removable door opens downward to provide access to electronic components and to a terminal block. Door is secured to prevent accidental dropping or disengagement. A clearance of 13" (330mm) at the rear is required in order to remove the door. Complete with a bird guard protecting against birds and similar intruders and an ANSI label to identify wattage and source (both included in box). Housing (including electrical compartment) rated IP54 per ANSI C136.37.

### Light Engine

Composed of 4 main components: LED Module / Optical System / Heat Sink / Driver

Electrical components are RoHS compliant, IP66 sealed light engine equipped with Philips Lumileds LUXEON T LEDs. LEDs tested by ISO 17025-2005 accredited lab in accordance with IESNA LM-80 guidelines in compliance with EPA ENERGY STAR, extrapolations in accordance with IESNA TM-21. Metal core board ensures greater heat transfer and longer lifespan.

**LED Module** (Included), LED type Philips Lumileds LUXEON T. Composed of high performance white LEDs. Color temperature as per ANSI bin 4000 Kelvin nominal (3985K +/- 275K), CRI 70 Min. 75 Typical.

**Optical System:** Composed of high performance optical grade polymer refractor lenses to achieve desired distribution optimized to get maximum spacing, target lumens and a superior lighting uniformity. System is rated IP66. Performance shall be tested per LM-63, LM-79 and TM-15 (IESNA) certifying its photometric performance. Dark Sky compliant with 0% uplight and U0 per IESNA TM-15.

**Heat Sink:** Built in the housing, designed to ensure high efficacy and superior cooling by natural vertical convection air flow pattern always close to LEDs and driver optimising their efficiency and life. Product does not use any cooling device with moving parts (only passive cooling). Wide openings enable natural cleaning and removal of dirt and debris. Entire luminaire is rated for operation in ambient temperature of -40°C / -40°F up to +40°C / +104°F.

# RFM RoadFocus LED Cobrahead, Medium

72, 108, and 160W

## Specifications (continued)

**Driver:** High power factor of 90% min. Electronic driver, operating range 50/60 Hz. Auto adjusting universal voltage input from 120 to 277 or 347 to 480 VAC rated for both application line to line or line to neutral. Class I, THD of 20% max.

**(DMG), Dimming compatible 0-10 volts.** The current supplying the LEDs will be reduced by the driver if the driver experiences internal overheating as a protection to the LEDs and the electrical components. Output is protected from short circuits, voltage overload and current overload. Automatic recovery after correction. Standard built in driver surge protection of 2.5kV (min).

### Integrated Features

**DMG:** Dimmable driver 0-10V.

**RCD\***: Receptacle with 5 pins enabling dimming, can be used with a twist lock Starsense or photoelectric cell or a shorting cap.

**WC10:** 10-year limited warranty from defects in material and workmanship in its intended use, as well as coverage for finish. Visit website for more details.

**SP1:** Surge protection device tested in accordance with ANSI/IEEE C62.45 per ANSI/IEEE C62.41.2 Scenario I Category C High Exposure 10kV/10kA waveforms for Line-Ground, Line-Neutral and Neutral-Ground, and in accordance with DOE MSSLC Model Specification for LED Roadway Luminaires Appendix D Electrical Immunity High test level 10kV/10kA.

*Please note that these integrated features always come with RoadFocus luminaire.*

*\* Use of photoelectric cell or shorting cap is required to ensure proper illumination.*

### Driver and Luminaire Options

**AMPD\***: Driver pre-programmed for compatibility with Amplight control system.

**AST\***: Pre-set driver for progressive start-up of the LED module(s) to optimize energy management and enhance visual comfort at start-up.

**CLO\***: Pre-set driver to manage the lumen depreciation by adjusting the power given to the LEDs offering the same lighting intensity during the entire lifespan of the LED module.

**DALI\***: Pre-set driver compatible with the DALI control system.

**OTL\***: Pre-set driver to signal end of life of the LED module(s) for better fixture management.

**CDMG\***: Dynamimmer standard dimming functionalities including pre-programmed scenarios to suit many applications and needs from safety to maximum energy savings

### Safety Mode:

CDMG525: 4 hours, 25% power dimming

CDMG550: 4 hours 50% power dimming

CDMG575: 4 hours 75% power dimming

### Median Mode:

CDMG25: 6 hours 25% power dimming

CDMG50: 6 hours 50% power dimming

CDMG75: 6 hours 75% power dimming

### Economy Mode:

CDMG25: 8 hours 25% power dimming

CDMG50: 8 hours 50% power dimming

CDMG75: 8 hours 75% power dimming

*\*Not available with HVU (347-480V)*

**FAWS:** Field Adjustable Wattage Selector, pre-set to the highest position, can be easily switched in the field to the required position. This reduces total luminaire wattage consumption and reduces the light level – see the FAWS multiplier chart for more details. **NOTE:** When using FAWS with dimming, set the switch to position 10 (maximum output) to enable dimming.

**SP2:** 20kV / 20kA surge protection device that provides extra protection beyond the SP1 10kV/10kA level.

**RCD7\***: Receptacle with 7 pins enabling dimming and additional functionality (to be determined), can be used with a twist lock Starsense node or photoelectric cell or a shorting cap.

*Please note: Additional hardware will be required to utilize the additional 2 pins on this receptacle.*

*\* Use of photoelectric cell or shorting cap is required to ensure proper illumination.*

### Luminaire Useful Life

Refer to IES files for energy consumption and delivered lumens for each option. Based on ISTMT in situ thermal testing in accordance with UL1598 and UL8750, Philips System Reliability Tool, Philips Advance data and Philips Lumileds LM-80/TM-21 data, expected to reach 100,000 + hours (72W32LED and 108W48LED at 700mA) or 94,500 hours (108W32LED and 160W48LED at 1050mA) with >L70 lumen maintenance @ 25°C. Luminaire Useful Life accounts for LED lumen maintenance AND all of these additional factors including: LED life, driver life, PCB substrate, solder joints, on/off cycles, burning hours and corrosion.

### Wiring

The connection of the luminaire is done using a terminal block connector 600V, 85A for use with #2 14 AWG. wires from the primary circuit, located inside the housing. Due to the inrush current that occurs with electronic drivers, recommend using a time delay or slow blow fuse to avoid unnecessary and unwanted fuse blowing that can occur with fast acting fuses.

### Hardware

All exposed screws shall be stainless steel with Ceramic primer seal basecoat to reduce seizing of the parts. All seals and sealing devices are made and/or lined with EPDM and/or silicone and/or rubber.

### Finish

Color in accordance with the AAMA 2603 standard. Application of polyester powder coat paint (4 mils/100 microns) with ± 1 mils/24 microns of tolerance. The Thermosetting resins provides a discoloration resistant finish in accordance with the ASTM D2244 standard, as well as luster retention in keeping with the ASTM D523 standard and humidity proof in accordance with the ASTM D2247 standard. The surface treatment achieves a minimum of 2000 hours for salt spray resistant finish in accordance with testing performed and per ASTM B117 standard.

### LED products manufacturing standard

The electronic components sensitive to electrostatic discharge (ESD) such as light emitting diodes (LEDs) are assembled in compliance with IEC61340-5-1 and ANSI/ESD S20.20 standards so as to eliminate ESD events that could decrease the useful life of the product.

### Vibration Resistance

The RFM meets the ANSI C136.31, American National Standard for Roadway Luminaire Vibration specifications for Bridge/overpass applications. (Tested for 3G over 100,000 cycles by an independent lab)

### Certifications and Compliance

cULus Listed for Canada and USA. Luminaire meets DOE and MSSLC Model Specification for LED Roadway Luminaires. RoadFocus LED Cobrahead luminaires are DesignLights Consortium qualified.

### Limited Warranty

10-year limited warranty. See philips.com/luminaires for details and restrictions.

### Brackets/Arms



**PHILIPS  
LUMEC**

Roadway

RoadFocus

35 and 54W RFS



Project: \_\_\_\_\_  
 Location: \_\_\_\_\_  
 Cat.No: \_\_\_\_\_  
 Type: \_\_\_\_\_  
 Lamps: \_\_\_\_\_ Qty: \_\_\_\_\_  
 Notes: \_\_\_\_\_

The Philips LumeC RoadFocus LED Cobra Head luminaires feature a sleek design that provides seamless replacement of existing HID luminaires. RoadFocus is available in three sizes, offers multiple lumen packages, and a complete array of optical distributions, making it an outstanding solution for multiple roadway applications.

**Ordering guide**

**Example:**RFS-35W16LED4K-T-R2S-UNIV-DMG-CLO-RCD-WC10-GY3

Luminaire	LED Module	Optical System	Voltage	Driver and Dimming	Wattage Switch	Twist-Lock Receptacle	Surge Protection	Warranty	Finish
<input type="text" value="RFS"/>	<input type="text"/>	<input type="text"/>	<input type="text" value="UNIV"/>	<input type="text"/>	<input type="text"/>	<input type="text"/>	<input type="text"/>	<input type="text" value="WC10"/>	<input type="text"/>
RFS RoadFocus Small	35W16LED4K-T or 54W16LED4K-T <sup>2</sup>	R2S Type II Short R2M Type II Medium R3S Type III Short R3M Type III Medium 5 Type V	UNIV 120-277VAC	<i>Standard:</i> DMG <sup>5,6</sup> Dimmable driver 0-10V  <i>Optional:</i> AMPD <sup>2,5,6</sup> Amplight Dimming DynaDimmer Economy Profile CDMGE25 <sup>2,5,6</sup> CDMGE50 <sup>2,5,6</sup> CDMGE75 <sup>2,5,6</sup> DynaDimmer Median Profile CDMGM25 <sup>2,5,6</sup> CDMGM50 <sup>2,5,6</sup> CDMGM75 <sup>2,5,6</sup> DynaDimmer Safety Profile CDMGS25 <sup>2,5,6</sup> CDMGS50 <sup>2,5,6</sup> CDMGS75 <sup>2,5,6</sup> DALI <sup>2,5,6</sup> Digitally Adressable Lighting Interface DMG-AST <sup>*2</sup> Adjustable Startup Time DMG-CLO <sup>*2,5</sup> Constant Light Output DMG-OTL <sup>*2</sup> Over The Life  <i>*Includes 0-10v Dimming</i>	FAWS <sup>5</sup> Field Adjustable Wattage Selector (optional)	<i>Standard:</i> RCD <sup>3,7</sup> Receptacle for twist-lock photocell or shorting cap, 5-pin (standard)  <i>Optional:</i> RCD7 <sup>3,7</sup> Receptacle for twist-lock photocell or shorting cap, 7-pin (optional)	SP2 <sup>8</sup> 20kV / 20kA Surge Protector (optional)	WC10 <sup>1</sup> 10-year limited warranty (standard)	BK Black Finish BR Bronze Finish GY3 Gray Finish WH White Finish

- 1. Please note these integrated features come standard with RoadFocus luminaires.
- 2. Denotes programmable driver option. Not available with 1050 mA version (54W16LED).
- 3. Use of photoelectric cell or shorting cap is required to ensure proper illumination.
- 4. Not available with HVU (347-480volt).
- 5. FAWS not available with AMPD, CDMG options, DALI or CLO.
- 6. Dimming choices: Select either DMG or AMPD or one of the CDMG options or DALI.
- 7. When RCD7 option is selected you will get 7-pin instead of standard RCD 5-pin.
- 8. When SP2 option is selected you will get SP2 instead of standard SP1.





# RFS RoadFocus LED Cobrahead, Small

## 35 and 54W

**Accessories** (must be ordered as separate line items - quickly and easily installed in the field)

<p><b>ACC-RFS-RFM-RFL-PH9<sup>9</sup></b> Shorting cap</p> <p><b>ACC-RFS-RFM-RFL-HS</b> House side shield, 1 per 16 LED light engine.</p> <p><b>ACC-RFS-RFM-RFL-UNIV-PH8<sup>9</sup></b> Twist-lock Photoelectric Cell, UNIV (120-277VAC).</p> <p><b>ACC-RFS-RFM-RFL-UNIV-PH8XL<sup>9</sup></b> Twist-lock Photoelectric Cell, extended life, UNIV (120-277VAC).</p>	<p><b>ACC-RFS-RFM-RFL-UNIV-SPC<sup>9,10</sup></b> Starsense twist-lock photoelectric cell &amp; antenna node, UNIV (120-277VAC).</p> <p><b>ACC-RFS-RFM-RFL-UNIV-SPCD<sup>9,10</sup></b> Starsense dimmable twist-lock photoelectric cell &amp; antenna node, UNIV (120-277VAC).</p>
--	---

9. Use of photoelectric cell or shorting cap is required to ensure proper illumination.

10. Please note that more hardware as well as software are required - please contact the quotations department for help with putting together the entire control system.

### LED Wattage and Lumen Values

LED = Philips Lumileds LUXEON T, CRI = 70, CCT = 4000K (+/- 350K)  
System (LED + driver) rated life = 100,000 hrs<sup>11</sup>

LED Module	Typical Delivered Lumens	Typical System Wattage (W) <sup>12</sup>	LED Current (mA)	Typical System Current (A) @				Efficacy (Lm/W)	BUG Rating
				120V	208V	240V	277V		
35W16LED4K-T-R2S	4,167	38	700	0.32	0.19	0.17	0.15	110	B1-U0-G1
35W16LED4K-T-R2M	3,955	38	700	0.32	0.19	0.17	0.15	104	B1-U0-G1
35W16LED4K-T-R3S	4,083	38	700	0.32	0.19	0.17	0.15	107	B1-U0-G1
35W16LED4K-T-R3M	4,030	38	700	0.32	0.19	0.17	0.15	108	B1-U0-G1
54W16LED4K-T-R2S	5,593	54	1050	0.46	0.27	0.23	0.20	104	B2-U0-G1
54W16LED4K-T-R2M	5,309	54	1050	0.46	0.27	0.23	0.20	99	B1-U0-G1
54W16LED4K-T-R3S	5,480	54	1050	0.46	0.27	0.23	0.20	102	B1-U0-G1
54W16LED4K-T-R3M	5,405	54	1050	0.46	0.27	0.23	0.20	100	B1-U0-G1

*Type V (5) IES files for all LED modules pending.*

11. L<sub>70</sub> >100,000 hrs (at ambient temperature = 25°C).

12. System wattage or total luminaire wattage includes the LED module and the LED driver.

Note: Due to rapid and continuous advances in LED technology, LED luminaire data is subject to change without notice and at the discretion of Philips.

### Field Adjustable Wattage (FAWS) Multiplier Chart

#### 35W16LED4K-T (700mA)

FAWS Position	Typical Delivered Lumens Multiplier	Typical System wattage and typical current
1	0.37	0.29
2	0.55	0.50
3	0.62	0.58
4	0.71	0.69
5	0.77	0.75
6	0.81	0.81
7	0.84	0.87
8	0.94	0.91
9	0.98	0.96
10	1.00	1.00

#### 54W16LED4K-T (1050mA)

FAWS Position	Typical Delivered Lumens Multiplier	Typical System wattage and typical current
1	0.33	0.27
2	0.56	0.48
3	0.64	0.57
4	0.71	0.65
5	0.79	0.74
6	0.84	0.79
7	0.89	0.85
8	0.92	0.90
9	0.96	0.95
10	1.00	1.00

# RFS RoadFocus LED Cobrahead, Small

35 and 54W

## Dimensions

Side View

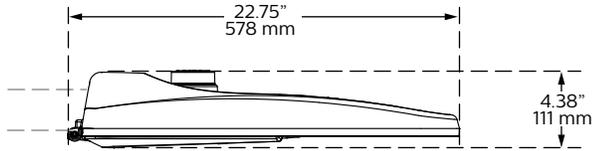

Bottom View

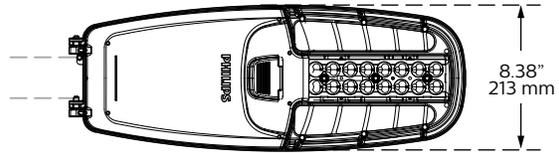

**Weight:** 9.4 Lbs

**EPA:** 0.52 sq. ft.

## Predicted Lumen Depreciation Data<sup>14,15,16</sup>

Ambient Temperature °C	Driver mA	Calculated L <sub>70</sub> Hours	L <sub>70</sub> per TM-21	Lumen Maintenance % at 60,000 hrs
25°C	up to 1050 mA	>100,000 hours	>60,000 hours	>96%

14. Predicted performance derived from LED manufacturer's data and engineering design estimates, based on IESNA LM-80 methodology. Actual experience may vary due to field application conditions.

15. L<sub>70</sub> is the predicted time when LED performance depreciates to 70% of initial lumen output.

16. Calculated per IESNA TM21-11. Published L<sub>70</sub> hours limited to 6 times actual LED test hours

## Specifications

### Housing

Made of a low copper die cast Aluminum alloy (A360), 0.100" (2.5mm) minimum thickness. Fits on a 1.66" (42mm) O.D. (1.25" NPS), 1.9" (48mm) O.D. (1.5" NPS) or 2 3/8" (60mm) O.D. (2" NPS) by 5 1/2" (140mm) minimum long tenon. Comes with a zinc plated clamp fixed by 2 zinc plated hexagonal bolts 3/8 16 UNC for ease of installation. Provides an easy step adjustment of +/- 5° tilt in 2.5° increments. Includes integral bubble level standard (always included). A quick release, tool less entry, single latch, hinged, removable door opens downward to provide access to electronic components and to a terminal block. Door is secured to prevent accidental dropping or disengagement. A clearance of 13" (330mm) at the rear is required in order to remove the door. Complete with a bird guard protecting against birds and similar intruders and an ANSI label to identify wattage and source (both included in box). Housing (including electrical compartment) rated IP54 per ANSI C136.37.

### Light Engine

Composed of 4 main components: LED Module / Optical System / Heat Sink / Driver

Electrical components are RoHS compliant, IP66 sealed light engine equipped with Philips Lumileds LUXEON T LEDs. LEDs tested by ISO 17025-2005 accredited lab in accordance with IESNA LM-80 guidelines in compliance with EPA ENERGY STAR, extrapolations in accordance with IESNA TM-21. Metal core board ensures greater heat transfer and longer lifespan.

**LED Module (Included).** LED type Philips Lumileds LUXEON T. Composed of high performance white LEDs. Color temperature as per ANSI bin 4000 Kelvin nominal (3985K +/- 275K), CRI 70 Min. 75 Typical.

**Optical System:** Composed of high performance optical grade polymer refractor lenses to achieve desired distribution optimized to get maximum spacing, target lumens and a superior lighting uniformity. System is rated IP66. Performance shall be tested per LM-63, LM-79 and TM-15 (IESNA) certifying its photometric performance. Dark Sky compliant with 0% uplight and U0 per IESNA TM-15.

**Heat Sink:** Built in the housing, designed to ensure high efficacy and superior cooling by natural vertical convection air flow pattern always close to LEDs and driver optimising their efficiency and life. Product does not use any cooling device with moving parts (only passive cooling). Wide openings enable natural cleaning and removal of dirt and debris. Entire luminaire is rated for operation in ambient temperature of -40°C / -40°F up to +40°C / +104°F.

**Driver:** High power factor of 90% min. Electronic driver, operating range 50/60 Hz. Auto adjusting universal voltage input from 120 to 277 VAC rated for both application line to line or line to neutral, Class I, THD of 20% max.

**(DMG).** Dimming compatible 0-10 volts. The current supplying the LEDs will be reduced by the driver if the driver experiences internal overheating as a protection to the LEDs and the electrical components. Output is protected from short circuits, voltage overload and current overload. Automatic recovery after correction. Standard built in driver surge protection of 2.5kV (min).

### Integrated Features

**DMG:** Dimmable driver 0-10V.

**RCD\*:** Receptacle with 5 pins enabling dimming, can be used with a twist lock Starsense or photoelectric cell or a shorting cap.

**WC10:** 10-year limited warranty from defects in material and workmanship in its intended use, as well as coverage for finish. Visit website for more details.

**SPI:** Surge protection device tested in accordance with ANSI/IEEE C62.45 per ANSI/IEEE C62.41.2 Scenario I Category C High Exposure 10kV/10kA waveforms for Line-Ground, Line-Neutral and Neutral-Ground, and in accordance with DOE MSSLC Model Specification for LED Roadway Luminaires Appendix D Electrical Immunity High test level 10kV/10kA.

*Please note that these integrated features always come with RoadFocus luminaire.*

*\* Use of photoelectric cell or shorting cap is required to ensure proper illumination.*

# RFS RoadFocus LED Cobrahead, Small

35 and 54W

## Specifications (continued)

### Driver and Luminaire Options

**AMPD:** Driver pre-programmed for compatibility with Amplight control system.

**AST:** Pre-set driver for progressive start-up of the LED module(s) to optimize energy management and enhance visual comfort at start-up.

**CLO:** Pre-set driver to manage the lumen depreciation by adjusting the power given to the LEDs offering the same lighting intensity during the entire lifespan of the LED module.

**DALI:** Pre-set driver compatible with the DALI control system.

**OTL:** Pre-set driver to signal end of life of the LED module(s) for better fixture management.

**CDMG:** Dynadimmer standard dimming functionalities including pre-programmed scenarios to suit many applications and needs from safety to maximum energy savings

#### Safety Mode:

CDMGS25: 4 hours, 25% power dimming

CDMGS50: 4 hours 50% power dimming

CDMGS75: 4 hours 75% power dimming

#### Median Mode:

CDMGM25: 6 hours 25% power dimming

CDMGM50: 6 hours 50% power dimming

CDMGM75: 6 hours 75% power dimming

#### Economy Mode:

CDMGE25: 8 hours 25% power dimming

CDMGE50: 8 hours 50% power dimming

CDMGE75: 8 hours 75% power dimming

**FAWS:** Field Adjustable Wattage Selector, pre-set to the highest position, can be easily switched in the field to the required position. This reduces total luminaire wattage consumption and reduces the light level – see the FAWS multiplier chart for more details. *NOTE: When using FAWS with dimming, set the switch to position 10 (maximum output) to enable dimming.*

**SP2:** 20kV / 20kA surge protection device that provides extra protection beyond the SP1 10kV/10kA level.

**RCD7\*:** Receptacle with 7 pins enabling dimming and additional functionality (to be determined), can be used with a twist lock Starsense node or photoelectric cell or a shorting cap.

*Please note: Additional hardware will be required to utilize the additional 2 pins on this receptacle.*

*\* Use of photoelectric cell or shorting cap is required to ensure proper illumination.*

### Luminaire Useful Life

Refer to IES files for energy consumption and delivered lumens for each option. Based on ISTMT in situ thermal testing in accordance with UL1598 and UL8750, Philips System Reliability Tool, Philips Advance data and Philips Lumileds LM-80/TM-21 data, expected to reach 100,000 + hours with >L70 lumen maintenance @ 25°C. Luminaire Useful Life accounts for LED lumen maintenance AND all of these additional factors including: LED life, driver life, PCB substrate, solder joints, on/off cycles, burning hours and corrosion.

### Wiring

The connection of the luminaire is done using a terminal block connector 600V, 85A for use with #2 14 AWG. wires from the primary circuit, located inside the housing. Due to the inrush current that occurs with electronic drivers, recommend using a time delay or slow blow fuse to avoid unnecessary and unwanted fuse blowing that can occur with fast acting fuses.

### Hardware

All exposed screws shall be stainless steel with Ceramic primer seal basecoat to reduce seizing of the parts. All seals and sealing devices are made and/or lined with EPDM and/or silicone and/or rubber.

### Finish

Color in accordance with the AAMA 2603 standard. Application of polyester powder coat paint (4 mils/100 microns) with ± 1 mils/24 microns of tolerance. The Thermosetting resins provides a discoloration resistant finish in accordance with the ASTM D2244 standard, as well as luster retention in keeping with the ASTM D523 standard and humidity proof in accordance with the ASTM D2247 standard. The surface treatment achieves a minimum of 2000 hours for salt spray resistant finish in accordance with testing performed and per ASTM B117 standard.

### LED products manufacturing standard

The electronic components sensitive to electrostatic discharge (ESD) such as light emitting diodes (LEDs) are assembled in compliance with IEC61340-5-1 and ANSI/ESD S20.20 standards so as to eliminate ESD events that could decrease the useful life of the product.

### Vibration Resistance

The RFS meets the ANSI C136.31, American National Standard for Roadway Luminaire Vibration specifications for Bridge/overpass applications. (Tested for 3G over 100,000 cycles by an independent lab)

### Certifications and Compliance

cULus Listed for Canada and USA. Luminaire meets DOE and MSSLC Model Specification for LED Roadway Luminaires. RoadFocus LED Cobrahead luminaires are DesignLights Consortium qualified.

### Limited Warranty

10-year limited warranty. See philips.com/luminaires for details and restrictions.

### Brackets/Arms

For brackets / arms available with this luminaire, see Lumec 3D for details.





## ITE Compliant LED Signal Modules



Designed in the U.S.A  
Meets Buy American provision under the  
American Recovery and Reinvestment Act 2009  
For projects requiring Buy American provision certification, consult factory for  
additional information and special ordering details

# ITE Compliant LED Traffic Signal Module Performance Specifications

## All LED Ball Signal Modules (8 inch (200mm) and 12 inch (300mm))

shall be fully compliant to the ITE VTC SH LED Circular Supplement specifications dated and adopted June 27, 2005. Compliance to the ITE VTC SH-2 Interim Purchase Specification is not sufficient, and will not substitute for compliance to the ITE VTC SH LED Circular Supplement specifications. Additionally, prior to bid award, the manufacturer shall submit to purchaser, reports from ETL/Intertek, that certify full compliance of all LED ball signal modules to the entire ITE specification. These tests should include but not be limited to the luminous intensity measurements and requirements outlined in the ITE specification sections 6.4.4 through 6.4.4.4.2 (25°C and 74°C / 49°C). Evidence of full compliance to all required testing methods, procedures and sections as outlined in the above ITE document Figure 2, Design Qualification Testing Flow Chart must be included without any exceptions, changes or omissions. The manufacturer must also submit a data sheet showing the exact catalog number of the items submitted on the bid and the Independent Lab report must show full qualification of this catalog number.

To ensure optimal quality of illumination; uniformity; reliability; and appearance, all ball traffic signal modules shall utilize Hi-flux LEDs rated at 1-watt or higher, as their source of illumination. To ensure competency of design and manufacturing, manufacturers of ball, arrow, and pedestrian signal modules shall have a minimum of 7 years of experience in utilizing Hi-flux LEDs rated at 1-watt or higher, as the source of illumination in their ball traffic signal modules. Additionally, manufacturers must have utilized in excess of 20 million Hi-flux LEDs in their LED traffic signal modules during the most recent 10 year period.



## All LED 12 inch (300 mm) Arrow Signal Modules

shall be fully compliant to the "Omni-directional" specifications of the ITE VTC SH - LED Vehicle Arrow Traffic Signal Supplement adopted July 1, 2007. Additionally, prior to bid award, the manufacturer shall submit to purchaser, reports from ETL/Intertek that certify full compliance of all LED Arrow signal modules. These tests should include but not be limited to the luminous intensity measurements and requirements outlined in the ITE specification sections 6.4.4 through 6.4.4.4.2 (25°C and 74°C / 49°C). Evidence of full compliance to all required testing methods, procedures and sections as outlined in the above ITE document Attachment 1, "Design Qualification Testing Flow Chart" must be included without any exceptions, changes or omissions. The manufacturer must also submit a data sheet showing the exact catalog number of the items submitted on the bid and the Independent Lab report must show full qualification of this catalog number.

## All LED 16x18 Countdown Pedestrian Signal Modules

shall be fully compliant to the ITE PTC SI Part-2: LED Pedestrian Traffic Signal Modules specifications adopted August 4, 2010 or the latest adopted version as listed on the ITE website at time of bid. Additionally, prior to bid award, the manufacturer shall submit to purchaser, reports from ETL/Intertek that certify full compliance of LED signal modules, to these specifications. Evidence of full compliance to all required testing methods, procedures and sections as outlined in the above ITE document Attachment 2, "Design Qualification Testing Flow Chart" must be included without any exceptions, changes or omissions. The manufacturer must also submit a data sheet showing the exact catalog number of the items submitted on the bid and the Independent Lab report must show full qualification of this catalog number. Combination hand/person pedestrian signal modules shall incorporate separate power supplies for the hand and the person icons.

In addition to, and in excess of the above applicable ITE specification compliance, the on-board circuitry of all LED traffic signal modules shall include voltage surge protection, to withstand high-repetition noise transients and low-repetition high-energy transients as stated in Section 2.1.8, NEMA Standard TS 2-2003. In addition, the module shall comply with the following standards: IEC 1000-4-5 at 3kV with a 2 ohm source impedance, ANSI/IEEE C62, 41-2002; IEC 61000-4-12 (6kV, 200A, 100kHz ring wave).

## Warranty:

Manufacturer shall provide at time of bid, a written warranty which provides for repair or replacement of modules that fail to function as intended due to workmanship or material defects within the first 60 months from date of delivery. Modules which exhibit luminous intensities less than the minimum as specified in the ITE specifications as indicated above, within the first 60 months from date of delivery shall be replaced or repaired.

## Notes:

- CSA approved to the following applicable requirements:
- CSA Standard C22.2 No. 9.0-96 General Requirements for Luminaires
- CSA Std. No. C22.2 No. 250.0-04 Luminaires
- UL Std. No. 1598-2004 (May 2006) Luminaires



Designed in the U.S.A  
Meets Buy American provision  
under the American Recovery and  
Reinvestment Act 2009

For projects requiring Buy American provision certification,  
consult factory for additional information  
and special ordering details

# Uniform Appearance LED Traffic Signal Modules



- ▲ \*Fully compliant to ITE VTCSH-LED Circular Signal Supplement dated 6/27/2005
- ▲ Industry's lowest power for all colors
- ▲ Meets or exceeds ITE intensity, color and uniformity specification, including 49°C / 74°C requirements
- ▲ Temperature compensated power supplies for longer LED life
- ▲ Uniform appearance
- ▲ Expanded view radiation pattern suitable for span wire and steep grade applications
- ▲ Transient suppression exceeds ITE and NEMA specifications (Up to 6KV ring wave)
- ▲ Manufactured with anti-capillary wires
- ▲ Conformal coated power supply
- ▲ Secondary lens treatment for abrasion resistance
- ▲ Patent No. 7,281,818 and other patents pending
- ▲ Intertek/ETL certified and listed on ETL certification program
- ▲ All units operate at 80-135VAC RMS, 60±3Hz

Part Number	Color	Lens Type	Dominant Wavelength (nm)	Typical Wattage at 25°C	Peak Minimum Maintained Luminous Intensity (cd)	*Meets ITE VTCSH LED Circular Signal Supplement	CSA Approved	Size (in)
433-1110-003XL	Red	Tinted	625	6	165	✓	✓	8
433-1170-003XL	Red	Clear	625	6	165	✓	✓	8
433-3130-901XL	Yellow	Tinted	590	7	410	✓	✓	8
433-3170-901XL	Yellow	Clear	590	7	410	✓	✓	8
433-2120-001XL	Green	Tinted	500	8	215	✓	✓	8
433-2170-001XL	Green	Clear	500	8	215	✓	✓	8
433-1210-003XL	Red	Tinted	625	6	365	✓	✓	12
433-1270-003XL	Red	Clear	625	6	365	✓	✓	12
433-3230-901XL	Yellow	Tinted	590	12	910	✓	✓	12
433-3270-901XL	Yellow	Clear	590	12	910	✓	✓	12
433-2220-001XL	Green	Tinted	500	7	475	✓	✓	12
433-2270-001XL	Green	Clear	500	7	475	✓	✓	12

## OMNI-DIRECTIONAL, UNIFORM APPEARANCE LED ARROWS

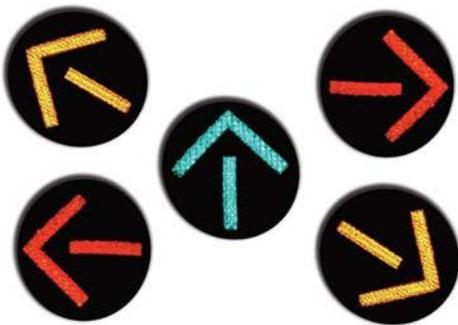

- ▲ \*Fully compliant to ITE VTCSH-LED Vehicle Arrow Supplement dated 7/01/2007
- ▲ Allows for mounting in any orientation in the signal head
- ▲ Industry's lowest power for all colors
- ▲ Meets or exceeds ITE intensity, color and uniformity specification, including 49°C / 74°C requirements
- ▲ Temperature compensated power supplies for longer LED life
- ▲ Uniform appearance
- ▲ Transient suppression exceeds ITE and NEMA specifications (Up to 6KV ring wave)
- ▲ Manufactured with anti-capillary wires
- ▲ Conformal coated power supply
- ▲ Secondary lens treatment for abrasion resistance
- ▲ Intertek/ETL certified and listed on ETL certification program
- ▲ All units operate at 80-135VAC RMS, 60±3Hz

Part Number	Color	Lens Type	Typical Wattage at 25°C	Dominant Wavelength (nm)	Peak Minimum Maintained Luminous Intensity (cd)	*Meets ITE Spec	CSA Approved
432-1314-001XOD	Red	Tinted	6	628	56.8	✓	✓
432-1374-001XOD	Red	Clear	6	628	56.8	✓	✓
431-3334-901XOD	Yellow	Tinted	6	590	141.6	✓	✓
431-3374-901XOD	Yellow	Clear	6	590	141.6	✓	✓
432-2324-001XOD	Green	Tinted	6	500	73.9	✓	✓
432-2374-001XOD	Green	Clear	6	500	73.9	✓	✓

# Uniform Appearance Hand and Person Pedestrian Signals



- ▲ \*Fully compliant to ITE PTCI Part 2 LED Pedestrian Traffic Signal Module Specification adopted 3/9/04
- ▲ Meets / exceeds ITE uniformity ratio of not more than 1 to 5 between the max and min luminance values as measured in (.5") dia spots
- ▲ Manufactured with anti-capillary wires
- ▲ Conformal coated power supply
- ▲ Fuse and transient suppressor incorporated for superior line and load protection
- ▲ Independent dedicated power supplies for added safety and reliability
- ▲ Intertek/ETL certified and listed on ETL certification program
- ▲ Transient suppression exceeds ITE and NEMA specifications (Up to 6KV ring wave)
- ▲ All units operate at 80-135VAC RMS, 60±3Hz

Part Number	Size	Description	Typical Wattage @ 25°C		Min. Luminance (cd/m <sup>2</sup> )		*Meets ITE Spec	CSA Approved
			Hand	Person	Hand	Person		
430-6450-001X	16 x 18	Side-by-side Hand and Person	8	7	1,400	2,200	✓	✓
430-6472-001X	16 x 18	Overlay Hand and Person	8	6	1,400	2,200	✓	✓
430-5770-001X	12 x 12	Hand only	8	N/A	1,400	N/A	✓	✓
430-7771-001X	12 x 12	Person only	N/A	7	N/A	2,200	✓	✓
430-6772-001X	12 x 12	Overlay Hand and Person	8	6	1,400	2,200	✓	✓
430-5570-001X	9 x 9	Hand only	6	N/A	1,400	N/A	✓	
430-7570-001X	9 x 9	Person only	N/A	6	N/A	2,200	✓	

# Uniform Appearance Countdown Pedestrian Signals



- ▲ \*Fully compliant to ITE PTCI Part 2 LED Pedestrian Traffic Signal Module Specification adopted 8/04/2010
- ▲ MUTCD compliant for countdown applications
- ▲ Full preemption compatibility
- ▲ Up to 8 units can be connected in parallel without affecting of the monitoring of the Hand/Person
- ▲ Manufactured with anti-capillary wires
- ▲ Three (3) Independent dedicated power supplies for added safety and reliability
- ▲ Intertek/ETL certified and listed on ETL certification program
- ▲ Reduced off state icon visibility results in increased pedestrian safety by eliminating the potential to misinterpret the signal
- ▲ Conformal coated power supply
- ▲ New improved one piece housing design
- ▲ Improved optical design to provide superior uniform appearance of the icons
- ▲ Transient suppression exceeds ITE and NEMA specifications (Up to 6KV ring wave)
- ▲ All units operate at 80-135VAC RMS, 60±3Hz

Part Number	Housing Size	Symbol Color			Typical Wattage @ 25°C			Min. Luminance (cd/m <sup>2</sup> )			*Meets ITE Spec	CSA Approved
		Countdown	Hand	Person	Countdown	Hand	Person	Countdown	Hand	Person		
430-6479-001X	16 x 18	Portland Orange	Portland Orange	Lunar White	8	11	10	1,400	1,400	2,200	✓	✓
430-7773-001X	12 x 12	Portland Orange	N/A	N/A	5	N/A	N/A	1,400	N/A	N/A		✓

**Special Applications:** Upon customer request, above units are available with option to countdown the clearance mode and the walk mode. Add suffix "W" to above part numbers.

**IMPORTANT NOTE:** MUTCD DOES NOT recommend the use of a countdown timer in the "walk" mode

Dialight reserves the right to make changes at any time in order to supply the best product possible.

The most current version of this document will always be available at:  
[www.dialight.com/Assets/Brochures\\_And\\_Catalogs/Signaling/ITE\\_Spec\\_Brochure.pdf](http://www.dialight.com/Assets/Brochures_And_Catalogs/Signaling/ITE_Spec_Brochure.pdf)

## 12" ITE COMPLIANT XOD15 Long Life LED Arrow Traffic Signals

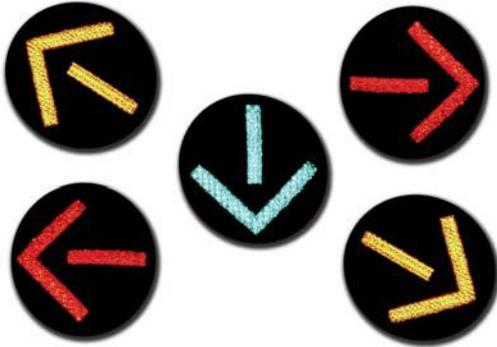

Patent Pending

### Application:

Fully compliant to the latest ITE Specifications, Dialight offers a full product line of LED traffic signal modules, arrows and pedestrian signals. Featuring the lowest wattage in the industry, Dialight's LED Traffic Signals are helping municipalities worldwide cut energy costs and reduce maintenance.

### Electrical specifications

Operating Voltage:	80V AC - 135V AC (120V AC nominal)
Operating Temp Range:	-40°C to +74°C
Turn-on / Turn-off Time:	< 75 msec
Power Factor:	> 0.9
Total Harmonic Distortion:	< 20%
Failed State Impedance:	> 250K ohm within 300ms

### Certifications

- IEC 1000-4-5, 3KV, 2 ohm source impedance
- ANSI/IEEE C62, 41-2002; IEC 61000-4-12, 6KV, 200A, 100KHz ring wave
- NEMA TS-2 Sec. 2.1.6 and Sec. 2.1.8

### Features & Benefits

- 15 year full performance warranty
- Enhanced thermal management
- All modules meet the ITE VTC SH LED Vehicle Arrow Traffic Signal Supplement over the full temperature range of -40°C to + 70°C
- All modules meet the ITE VTC SH-LED Circular Signal Supplement over the full temperature range of -40°C to +74°C
- Robust Hi-Flux LED technology
- Meets / exceeds ITE uniformity specifications (Better than 10-to-1)
- Transient suppression exceeds ITE and NEMA specifications (Up to 6KV)
- Meets / exceeds ITE moisture intrusion specifications
- Meets / exceeds ITE failed state impedance specifications
- Hard coated lenses for abrasion resistance
- Intertek-ETL certification
- Long life power supply is conformally coated for robust operation

### Ordering Information

Part Number <sup>1</sup>	Color	Lens Type	Dominant Wavelength (NM)	Typical Wattage at 25°C
432-1314-001XOD15	Red	Tinted	625	7
431-3334-901XOD15	Yellow	Tinted	590	13
432-2324-001XOD15	Green	Tinted	500	7
432-2374-001XOD15	Green	Clear	500	7

Red and yellow modules also available with clear lens. Insert "7" into the 6th position of the part number to designate clear lens. Ex: 432-1314-001XOD15 now becomes 432-1374-001XOD15

Dialight reserves the right to make changes at any time in order to supply the best product possible. The most current version of this document will always be available at: [www.dialight.com/Assets/Brochures\\_And\\_Catalogs/signaling/MDTITEXOD15X001.pdf](http://www.dialight.com/Assets/Brochures_And_Catalogs/signaling/MDTITEXOD15X001.pdf)

Warranty Statement: EXCEPT FOR THE WARRANTY EXPRESSLY PROVIDED FOR [HEREIN/ABOVE/BELOW], DIALIGHT DISCLAIMS ANY AND ALL OTHER WARRANTIES, EXPRESS OR IMPLIED, INCLUDING, WITHOUT LIMITATION, ANY WARRANTIES OF MERCHANTABILITY, FITNESS FOR A PARTICULAR PURPOSE, TITLE, AND NON-INFRINGEMENT.



Leading the LED Industry Since 1992  
With over 7,000,000 units installed globally

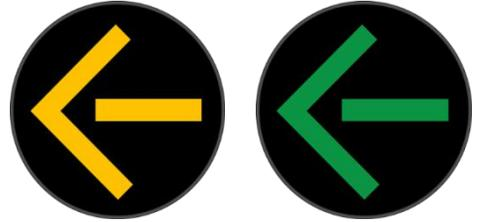

## Superior Performance and Reliability

- “Fail-State Impedance” design
- Environmentally friendly
- Significant energy and maintenance savings
- 12” modules
- Multiple connections available for specific applications
- Exceptional color uniformity and readability
- Excellent moisture and dust resistance through complete O-ring sealing
- Robust hard-coated and UV-stabilized polycarbonate lens for increased longevity against the elements
- Built-in Constant Current Source (CCS) provides uniform light output from the first to the last modules
- Maintains 70% of the initial lumen intensity after 100,000 hours of operation
- 5-Year Limited Warranty

## Mechanical Dimensions [in(mm)]

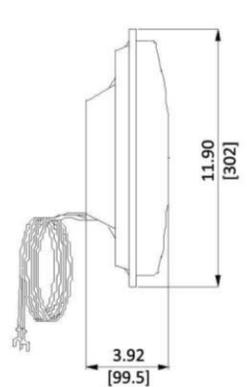
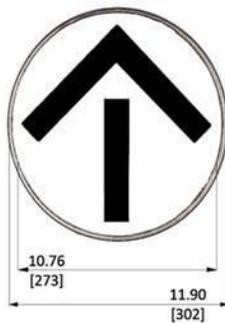

# Model Specifications and Ordering Options

Operating Temperature:	-40°F to 165°F (-40°C to 74°C)	Turn-On/Turn-Off Time:	<75msec
Operating Voltage:	80 - 135Vac	Turn-Off Voltage:	>35Vac
Power Factor:	>0.90	Total Harmonic Distortion (THD):	<20%

Model Number and Color	Wattage Drawn	Voltage	Dominant Wavelength	Maintained Intensity (cd) Min.	Standard
<b>12 inch</b>					
TSL-12BM-LD-A1 	7 6.2	80-135Vac	589 500	146 76	ITE 2007

## Standard Conformance

- FCC Compliant for Electrical Noise
- MIL-STD-810F Moisture Resistant
- MIL-STD-883 Mechanical Vibration
- NEMA TS2 Transient Voltage Protection over 2000V



Leading the LED Industry Since 1992  
With over 7,000,000 units installed globally



12 inch



8 inch

## Superior Performance and Reliability

- Intertek ETL verified
- Meets and/or exceeds all ITE standards ITE VTCSH LED Arrow Signal Supplement dated July 1, 2007
- Easy installation into existing signal housings
- Patented innovative optical technology
- Wider viewing angle and enhanced uniformity
- Maintains 70% of the initial lumen intensity after 100,000 hours of operation
- Overmolded electrical connectors provide fully-weatherized seal
- Excellent moisture and dust resistance
- Utilizes constant current source to maintain consistent light output
- Superior thermal management
- Energy efficient and environmentally friendly
- 5-year limited warranty

## Mechanical Dimensions [in(mm)]

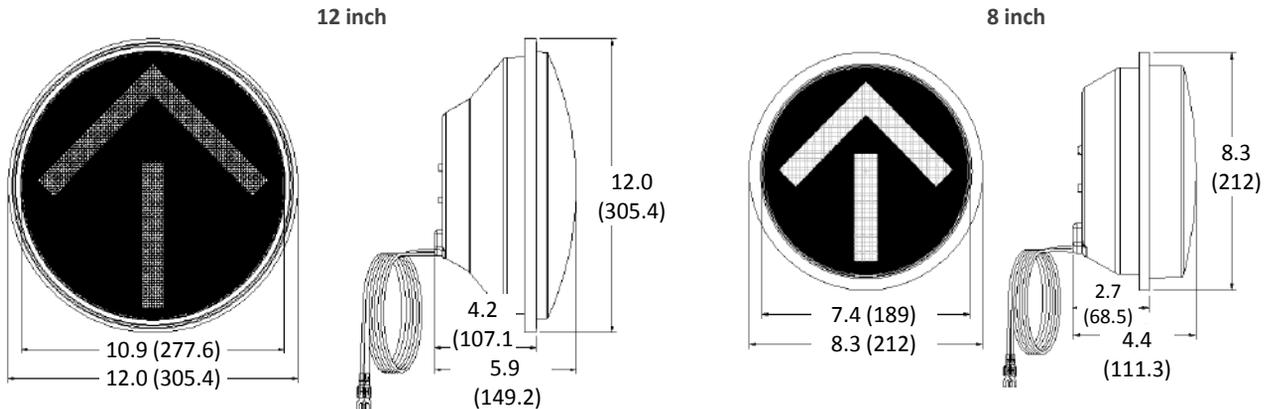

# Model Specifications and Ordering Options

Operating Temperature: -40°F to 165°F (-40°C to 74°C)	Turn-On/Turn-Off Time: < 75msec
Operating Voltage: 80 - 135Vac	Turn-Off Voltage: > 35Vac
Power Factor: > 0.90	Total Harmonic Distortion (THD): < 20%

	Model Number and Color	Wattage Drawn	Voltage	Dominant Wavelength	Maintained Intensity (cd)		
					Min.	Standard	
IL6-P3	<b>8 inch arrow</b>						
	TSL-08RA-IL6-A1-P3 	5.5	80-135Vac	626	N/A	N/A	
	TSL-08YA-IL6-A1-P3 	6	80-135Vac	589	N/A	N/A	
	TSL-08GA-IL6-A1-P3 	6	80-135Vac	500	N/A	N/A	
	<b>12 inch arrow</b>						
	TSL-12RA-IL6-A1-P3 	5.5	80-135Vac	626	58.4	ITE 2007/ETL	
	TSL-12YA-IL6-A1-P3 	7.3	80-135Vac	589	145.6	ITE 2007/ETL	
TSL-12GA-IL6-A1-P3 	6	80-135Vac	500	76.0	ITE 2007/ETL		
IL6-P2	<b>8 inch arrow</b>						
	TSL-08RA-IL6-A1 	6	80-135Vac	626	N/A	N/A	
	TSL-08YA-IL6-A1 	6.8	80-135Vac	589	N/A	N/A	
	TSL-08GA-IL6-A1 	6	80-135Vac	500	N/A	N/A	
	<b>12 inch arrow</b>						
	TSL-12RA-IL6-A1 	7	80-135Vac	626	58.4	ITE 2007/ETL	
	TSL-12YA-IL6-A1 	12.5	80-135Vac	589	145.6	ITE 2007/ETL	
TSL-12GA-IL6-A1 	7	80-135Vac	500	76.0	ITE 2007/ETL		

**Please note:** Tinted lens standard, clear lens optional. When ordering clear lens, please add “-CLR” to model number. Both tinted and clear lens are Intertek ETL Verified, for the 12” signal only.

## Standard Conformance

- FCC Compliant for Electrical Noise
- MIL-STD-810F Moisture Resistant
- MIL-STD-883 Mechanical Vibration
- NEMA TS2 Transient Voltage Protection over 2000V

### ITE VTCSH Compliance - LED Circular Signal Supplement – July 1, 2007

- Conditioning ITE 6.4.2 · Luminous Intensity ITE 6.4.4.1-4
- Mechanical Vibration ITE 6.4.3.1 · Chromaticity ITE 6.4.4.6
- Temperature Cycling ITE 6.4.3.2 · Current Consumption ITE 6.4.6.1



**Leading the LED Industry Since 1992**  
With over 7,000,000 units installed globally



### Superior Performance and Reliability

- Unique masking options available
- Intertek ETL verified
- Meets and/or exceeds all ITE standards ITE VTCSH LED Circular Signal Supplement dated June 27<sup>th</sup> 2005
- More energy efficient than previous model
- Easy installation into existing signal housings
- Patented innovative optical technology
- Wider viewing angle and enhanced uniformity
- Maintains 70% of the initial lumen intensity after 100,000 hours of operation
- Overmolded electrical connectors provide fully-weatherized seal
- Excellent moisture and dust resistance
- Utilizes constant current source to maintain consistent light output
- Superior thermal management
- Environmentally friendly
- 5-year limited warranty

### Mechanical Dimensions [in(mm)]

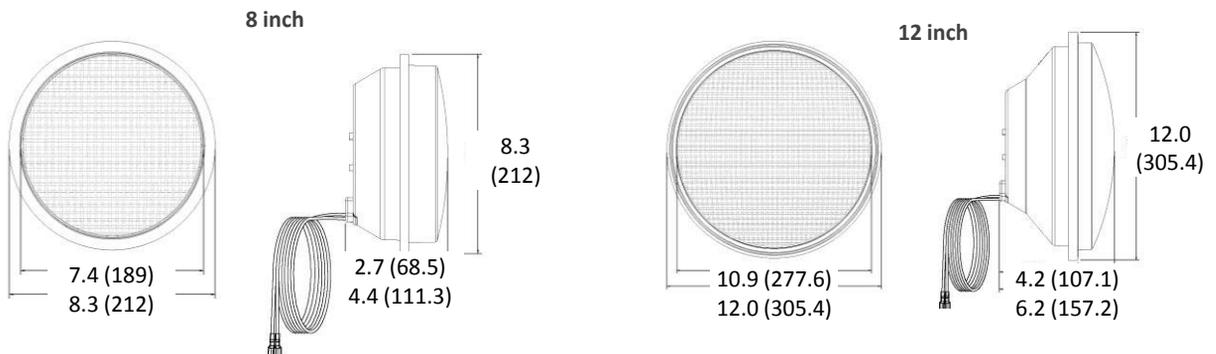

# Model Specifications and Ordering Options

Operating Temperature:	-40°F to 165°F (-40°C to 74°C)	Turn-On/Turn-Off Time:	< 75msec
Operating Voltage:	80 - 135Vac	Turn-Off Voltage:	> 35Vac
Power Factor:	> 0.90	Total Harmonic Distortion (THD):	< 20%

	Model Number and Color	Wattage Drawn	Voltage	Dominant Wavelength	Maintained Intensity (cd)		
					Min.	Standard	
IL6-P3	<b>8 inch ball</b>						
	TSL-08R-LX-IL6-A1-P3 	5.5	80-135Vac	626	165	ITE 2005/ETL	
	TSL-08Y-LX-IL6-A1-P3 	6	80-135Vac	589	410	ITE 2005/ETL	
	TSL-08G-LX-IL6-A1-P3 	6	80-135Vac	500	215	ITE 2005/ETL	
	<b>12 inch ball</b>						
	TSL-12R-LX-IL6-A1-P3 	5.6	80-135Vac	626	365	ITE 2005/ETL	
	TSL-12Y-LX-IL6-A1-P3 	8.8	80-135Vac	589	910	ITE 2005/ETL	
	TSL-12G-LX-IL6-A1-P3 	6.7	80-135Vac	500	475	ITE 2005/ETL	
	IL6-P2	<b>8 inch ball</b>					
TSL-08R-LX-IL6-A1-P2 		6	80-135Vac	626	165	ITE 2005/ETL/Caltrans	
TSL-08Y-LX-IL6-A1-P2 		6.8	80-135Vac	589	410	ITE 2005/ETL/Caltrans	
TSL-08G-LX-IL6-A1-P2 		6	80-135Vac	500	215	ITE 2005/ETL/Caltrans	
<b>12 inch ball</b>							
TSL-12R-LX-IL6-A1-P2 		6.9	80-135Vac	626	365	ITE 2005/ETL/Caltrans	
TSL-12Y-LX-IL6-A1-P2 		11.2	80-135Vac	589	910	ITE 2005/ETL/Caltrans	
TSL-12G-LX-IL6-A1-P2 		6.7	80-135Vac	500	475	ITE 2005/ETL/Caltrans	

**Please note:** Tinted lens standard, clear lens optional. When ordering clear lens, please add "-CLR" to model number. Both tinted and clear lens are Intertek ETL Verified.

## Standard Conformance

- FCC Compliant for Electrical Noise
- MIL-STD-810F Moisture Resistant
- MIL-STD-883 Mechanical Vibration
- NEMA TS2 Transient Voltage Protection over 2000V

### ITE VTCSH Compliance - LED Circular Signal Supplement – June 27, 2005

- Conditioning           ITE 6.4.2   · Luminous Intensity       ITE 6.4.4.1-4
- Mechanical Vibration   ITE 6.4.3.1 · Chromaticity           ITE 6.4.4.6
- Temperature Cycling    ITE 6.4.3.2 · Current Consumption    ITE 6.4.6.1

